



# Petronet LNG Limited

GIDC Industrial Estate, Plot No. 7/A, Dahej  
Taluka : Vagra, Dist. Bharuch (Gujarat) - 392130 (India)  
Tel. : 02641 - 670200 / 257  
CIN: L74899DL 1998PLCO93073  
GST No. : 24AAACP8148D1ZM



REF: PLL/DHJ/PROJ/MoEF/2024/08

Date: 29.11.2024

To,

Director,  
Ministry of Env., Forest and Climate Change  
Indira Paryavaran Bhawan,  
Jorbagh Road,  
New Delhi – 110003

Sub : Six Monthly Compliance Report for the period from April,2024 to September,2024 w.r.t conditions stipulated by MOEF&CC with EC identification no. EC23A3501GJ5666975N Dtd:19th February,2024 for "Expansion of Regasification capacity of Dahej Terminal from 20 MMTPA to 25 MMTPA" at Plot No. 7-A, Dahej GIDC Estate, District Bharuch, Gujarat proposed by M/s. Petronet LNG Ltd. as on 30<sup>th</sup> September,2024.

Ref : EC Identification No. EC23A3501GJ5666975N Dtd: 19th February,2024

Dear Sir,

With reference to be above subject, Six Monthly Compliance Report for the period from April,2024 to September,2024 with respect to conditions stipulated by MOEF&CC with EC identification no. EC23A3501GJ5666975N Dtd: 19th February,2024 for "Expansion of Regasification capacity of Dahej Terminal from 20 MMTPA to 25 MMTPA" at Plot No. 7-A, Dahej GIDC Estate, District Bharuch, Gujarat proposed by M/s. Petronet LNG Ltd. as on 30<sup>th</sup> September,2024 is uploaded in "PARIVESH 2" portal.

This is for your information and reference.

Thanking you,

Yours faithfully,

For Petronet LNG Limited

  
29/11/2024

Nishant Patel  
CGM & Vice President (Projects)

Encl.: As above

Copy to:-

1) Director (Environment)  
Forests & Environment Department,  
Government of Gujarat,  
Block No. 14, 8<sup>th</sup> Floor, Sachivalaya,  
Gandhinagar – 382 010

2) MoEF & CC  
Integrated Regional Office  
Room No 407 & 409  
Sector 10A  
A Wing Aranya Bhawan  
Gandhinagar-382010

3) Unit Head - Bharuch Division  
Gujarat Pollution Control Board  
Paryavaran Bhavan, Sector-10 A  
GANDHINAGAR – 382 010 (Gujarat)

4) Regional Officer  
Gujarat Pollution Control Board  
C-11119\3, GIDC, Phase – 2 , Narmada Nagar  
Bharuch – 392015 (Gujarat)

Regd. Off.:

World Trade Centre, First Floor, Babar Road,  
Barakhamba Lane, New Delhi-110 001 (INDIA)  
Tel.: 011 - 23472525, 23411411 Fax : 23472550

Kochi Site :

Survey No. 347, Puthuvypu  
P.O. 682508, Kochi Kerala (INDIA)  
Tel.: 0484-2502268

**Your (Half Yearly Compliance Report) has been Submitted with following details**

<b>Proposal No</b>	IA/GJ/INFRA1/449648/2023
<b>Compliance ID</b>	72356127
<b>Compliance Number(For Tracking)</b>	EC/COMPLIANCE/72356127/2025
<b>Reporting Year</b>	2024
<b>Reporting Period</b>	01 Dec(01 Apr - 30 Sep)
<b>Submission Date</b>	06-01-2025
<b>RO/SRO Name</b>	Shrawan Kumar Verma
<b>RO/SRO Email</b>	kr099.ifs@nic.in
<b>State</b>	GUJARAT
<b>RO/SRO Office Address</b>	Integrated Regional Offices, Gandhi Nagar
<b>Note:-</b> SMS and E-Mail has been sent to Shrawan Kumar Verma, GUJARAT with Notification to Project Proponent.	

**Half Yearly Compliance Report****2024****01 Dec(01 Apr - 30 Sep)****Acknowledgement**

<b>Proposal Name</b>	Expansion of Regasification Capacity of Dahej Terminal from 20 MMTPA to 25 MMTPA at Plot No. 7-A, Dahej GIDC Estate, District Bharuch, Gujarat		
<b>Name of Entity / Corporate Office</b>	PETRONET LNG LIMITED		
<b>Village(s)</b>	Lakhigam		
<b>District</b>	BHARUCH		
<b>Proposal No.</b>	IA/GJ/INFRA1/449648/2023	<b>Category</b>	INFRA-1
<b>Plot / Survey / Khasra No.</b>	Plot No. 7/A	<b>Sub-District</b>	Vagra
<b>State</b>	GUJARAT	<b>Entity's PAN</b>	*****8148D
<b>MoEF File No.</b>	10/31/2022-IA.III	<b>Entity name as per PAN</b>	PETRONET LNG LIMITED

**Compliance Reporting Details**

<b>Reporting Year</b>	2024
<b>Remarks (if any)</b>	Six Monthly Compliance Report for the period of Apr-Sep'24
<b>Reporting Period</b>	01 Dec(01 Apr - 30 Sep)

**Details of Production and Project Area**

**Name of Entity / Corporate Office** PETRONET LNG LIMITED

	<b>Project Area as per EC Granted</b>	<b>Actual Project Area in Possession</b>
Private	0	0
Revenue Land	51.1621	51.1621
Forest	33.4079	33.4079
Others	0	0
<b>Total</b>	<b>84.57</b>	<b>84.57</b>

**Production Capacity**

Sr. no	Product Name	units	Valid Upto	Capacity	Production last year	Capacity as per CTO
1	RLNG	Million Tons per Annum (MTPA)	N/A	25MMTPA	16.0303 MMTPA	

**Conditions**

## Specific Conditions

Sr.No.	Condition Type	Condition Details
1	WASTE MANAGEMENT	Necessary arrangements for the treatment of the effluents and solid wastes/ facilitation of reception facilities under MARPOL must be made and it must be ensured that they conform to the standards laid down by the competent authorities including the Central or State Pollution Control Board and under the Environment (Protection) Act, 1986. The provisions of Solid Waste Management Rules, 2016. E-Waste Management Rules, 2016, and Plastic Waste Management Rules, 2016 shall be complied with.
<b>PPs Submission:</b> Agreed to Comply Noted and shall be complied.		Date: 29/11/2024
2	Statutory compliance	All the recommendations and conditions specified by the Gujarat State Coastal Zone Management Authority (GCZMA) vide letter no. Env-10-2023-29-T dated 03.11.2023 shall be complied with.
<b>PPs Submission:</b> Being Complied Recommendations and conditions of GCZMA are under implementation stage.		Date: 29/11/2024
3	Risk Mitigation and Disaster Management	All the conditions stipulated in the earlier clearances including the recommendations of Environment Management Plan, disaster management Plan shall be strictly complied with.
<b>PPs Submission:</b> Being Complied Noted and all the conditions in the earlier clearances are being complied and same is regularly uploaded on Parivesh portal.		Date: 29/11/2024
4	Marine/Coastal	As submitted by PP there shall not undertake any development of foreshore facilities and shall not undertake Marine disposal for the proposed project.
<b>PPs Submission:</b> Agreed to Comply The construction activities are limited to existing onshore land within the plant boundary and no foreshore activities are envisaged.		Date: 29/11/2024
5	WASTE MANAGEMENT	Spillage of fuel/engine oil and lubricants from the construction site are a source of organic pollution which impacts marine life, particularly benthos. This shall be prevented by suitable precautions and also by providing necessary mechanisms to trap the spillage.
<b>PPs Submission:</b> Agreed to Comply Adequate measures are being taken to prevent any spillage of oil at the source itself to prevent the marine life. Also, Oil spill contingency plan is in place.		Date: 29/11/2024
6	Marine/Coastal	The Project proponent shall ensure that no creeks or rivers are blocked due to any activities at the project site and free flow of water is maintained.
<b>PPs Submission:</b> Agreed to Comply The construction activities are limited to existing onshore land within the plant boundary and no creeks or rivers are blocked.		Date: 29/11/2024
7	Marine/Coastal	Shoreline should not be disturbed due to dumping. Periodical study on shore line changes shall be conducted and mitigation carried out, if necessary. The details shall be submitted along with the six monthly

		monitoring report.
<p><b>PPs Submission:</b> Complied The construction activities are limited to existing onshore land within the plant boundary and shoreline will not be disturbed.</p>		<p>Date: 29/11/2024</p>
8	WASTE MANAGEMENT	Necessary arrangements for the treatment of the effluents and solid wastes/ facilitation of reception facilities under MARPOL must be made and it must be ensured that they conform to he standards laid down by the competent authorities including the Central or State Pollution Control Board and under the Environment (Protection) Act, 1986. The provisions of Solid Waste Management Rules, 2016. E-Waste Management Rules, 2016, and Plastic Waste Management Rules, 2016 shall be complied with.
<p><b>PPs Submission:</b> Agreed to Comply Noted and shall be complied.</p>		<p>Date: 29/11/2024</p>
9	MISCELLANEOUS	The Project Proponent shall ensure that there shall be no damage to the existing mangroves patches near site and also ensure the free flow of water to avoid damage to the mangroves.
<p><b>PPs Submission:</b> Complied The construction activities are limited to existing onshore land within the plant boundary and there are no mangroves in the vicinity of the project site.</p>		<p>Date: 29/11/2024</p>
10	Marine/Coastal	"Marine ecology shall be monitored regularly in terms of micro, macro and mega flora and faunal components of coastal and marine environs(sea weeds, sea grasses, mudflats, sand dunes, fisheries, mangroves and other marine biodiversity components etc.), by nationally/internationally recognized institute. A site-specific biodiversity conservation plan including mitigation measures to be developed from competent nationally/internationally recognized institute with appropriate financial allocation for its implementation prior to commissioning of the proposed project. The implementation status of the same shall be submitted along with the certified compliance report to the concern IRO of this Ministry."
<p><b>PPs Submission:</b> Complied Marine Ecology study is being carried out on six monthly basis and report of the same is attached as Annexure-I.</p>		<p>Date: 29/11/2024</p>
11	Marine/Coastal	"The risk assessment and management plan being drawn up with regards to the environmental impacts of natural disasters, oil spills and other waste, dredging and dumping on marine ecology shall scrupulously implemented. It shall be ensured that the marine ecology in the area of influence shall not affect. The monitoring and compliance status of the marine ecology management plan shall submit along with the six monthly EC compliance reports."
<p><b>PPs Submission:</b> Being Complied "Marine ecology study has been carried out as per the said requirment and Marine Biodiversity plan is in place and will be adhered too. Marine Ecology study is being carried out on six monthly basis and report of the same is attached as Annexure-I."</p>		<p>Date: 29/11/2024</p>
12	WATER QUALITY MONITORING AND PRESERVATION	Ships/barges/vessels shall not be allowed to release any oil bilge waste or ballast water in the sea. Any effluents fromthe Jetty which have leachable characteristics shall be segregated and recycled/disposed as per SPCB guidelines. Ships/vessels calling at the jetty shall not dump waste/bilge water during the berthing period.

<p><b>PPs Submission:</b> Agreed to Comply Noted and MARPOL guidelines are being strictly followed.</p>		<p>Date: 29/11/2024</p>
13	<p>WATER QUALITY MONITORING AND PRESERVATION</p>	<p>Construction spoils, including bituminous material and other hazardous materials, must not be allowed to contaminate watercourses and the dump sites for such material must be secured so that they should not leach into the ground water.</p>
<p><b>PPs Submission:</b> Agreed to Comply Noted and same shall be ensured.</p>		<p>Date: 29/11/2024</p>
14	<p>Risk Mitigation and Disaster Management</p>	<p>The proponent shall put in place the detailed on site and off site Emergency Management Plan as per the Manufacture, Storage and Import of Hazardous Chemical Rules, 1989, as amended to date which may cover the natural disasters also.</p>
<p><b>PPs Submission:</b> Complied Emergency Response and Disaster Management plan is in place for on-site and off-site emergencies.</p>		<p>Date: 29/11/2024</p>
15	<p>MISCELLANEOUS</p>	<p>The PP shall develop a contingency plan for H2S release including all necessary aspects from evacuation to resumption of normal operations. The workers shall be provided with personal H2S detectors in locations of high risk of exposure along with self containing breathing apparatus.</p>
<p><b>PPs Submission:</b> Complied No H2S related hazard is associated with the nature of the project.</p>		<p>Date: 29/11/2024</p>
16	<p>Risk Mitigation and Disaster Management</p>	<p>Emergency Response Plan (ERP) shall be based on the guidelines prepared by OISD, DGMS and Govt. of India.</p>
<p><b>PPs Submission:</b> Complied Emergency Response and Disaster Management plan is in place for on-site and off-site emergencies.</p>		<p>Date: 29/11/2024</p>
17	<p>MISCELLANEOUS</p>	<p>No underwater blasting is permitted.</p>
<p><b>PPs Submission:</b> Agreed to Comply Noted and shall be complied. No underwater blasting shall be done.</p>		<p>Date: 29/11/2024</p>
18	<p>Marine/Coastal</p>	<p>Sediment analysis of harbor at identified locations shall be analyzed and records for past and present period shall be maintained.</p>
<p><b>PPs Submission:</b> Complied Sediment analysis is being carried out and records are available for both past and present period.</p>		<p>Date: 29/11/2024</p>
19	<p>Statutory compliance</p>	<p>Necessary approvals be taken during implementation and commissioning from statutory bodies concerned.</p>
<p><b>PPs Submission:</b> Being Complied At present, all required statutory clearances has been taken to start the construction of the project. If any other is required, it will be taken at that phase of the project.</p>		<p>Date: 29/11/2024</p>
20	<p>Statutory compliance</p>	<p>Construction activity and all other port related activity shall be carried out strictly according to the provisions of the CRZ Notification, 2011. No construction work other than those permitted</p>

		in Coastal Regulation Zone Notification shall be carried out in Coastal Regulation Zone area.
<b>PPs Submission:</b> Agreed to Comply Noted and no construction work other than permitted will be carried out in CRZ area.		<b>Date:</b> 29/11/2024
21	PUBLIC HEARING	All the commitments made to the public during public hearing/public consultation meeting shall be satisfactorily implemented and adequate budget provision shall be made accordingly.
<b>PPs Submission:</b> Complied This project was exempted from public hearing.		<b>Date:</b> 29/11/2024
22	Risk Mitigation and Disaster Management	All the recommendations mentioned in the risk assessment report, disaster management plan and safety guidelines shall be implemented.
<b>PPs Submission:</b> Complied All the recommendations are complied.		<b>Date:</b> 29/11/2024
23	WASTE MANAGEMENT	Wastes discharged from ships will be handed over to the port's licensed waste disposal contractors.
<b>PPs Submission:</b> Complied No ship waste discharge is allowed in the port area.		<b>Date:</b> 29/11/2024
24	Statutory compliance	Consent to Establish/Operate for the project shall be obtained from the State Pollution Control Board as required under the Air (Prevention and Control of Pollution) Act, 1981 and the Water (Prevention and Control of Pollution) Act, 1974.
<b>PPs Submission:</b> Being Complied CTE obtained and CTO will be obtained before commissioning of the project.		<b>Date:</b> 29/11/2024
25	PUBLIC HEARING	"As per the Ministry's Office Memorandum F. No. 22-65/2017-IA.III dated 30th September, 2020, the project proponent shall abide by all the commitments made by them to address the concerns raised during the public consultation. The project proponent shall initiate the activities proposed by them, based on the commitment made in the public hearing, and incorporate in the Environmental Management Plan and submit to the Ministry. All other activities including pollution control, environmental protection and conservation, R&R, wildlife and forest conservation/protection measures including the NPV, Compensatory Aforestationetc, either proposed by the project proponent based on the social impact assessment and R&R action plan carried out during the preparation of EIA report or prescribed by EAC, shall also be implemented and become part of EMP."
<b>PPs Submission:</b> Complied This project was exempted from Public hearing.		<b>Date:</b> 29/11/2024
<b>General Conditions</b>		
<b>Sr.No.</b>	<b>Condition Type</b>	<b>Condition Details</b>

1	WATER QUALITY MONITORING AND PRESERVATION	No ships docking at the proposed project site will discharge its on-board waste water untreated in to the estuary/ channel. All such wastewater load will be diverted to the proposed Effluent Treatment Plant of the project site.
<b>PPs Submission:</b> Agreed to Comply Noted and same shall be ensured.		Date: 29/11/2024
2	MISCELLANEOUS	The project proponent shall make public the environmental clearance granted for their project along with the environmental conditions and safeguards at their cost by prominently advertising it at least in two local newspapers of the District or State, of which one shall be in the vernacular language within seven days and in addition this shall also be displayed in the project proponent's website permanently.
<b>PPs Submission:</b> Complied Published in the two local newspaper dated 02.03.2024. Copy of the same is attached as Annexure-VII.		Date: 29/11/2024
3	MISCELLANEOUS	The copies of the environmental clearance shall be submitted by the project proponents to the Heads of local bodies, Panchayats and Municipal Bodies in addition to the relevant offices of the Government who in turn has to display the same for 30 days from the date of receipt.
<b>PPs Submission:</b> Complied EC copy submitted to the nearby villages for their information and display. Correspondence of the same is attached as as Annexure-VIII.		Date: 29/11/2024
4	MISCELLANEOUS	The project proponent shall upload the status of compliance of the stipulated environment clearance conditions, including results of monitored data on their website and update the same on half-yearly basis.
<b>PPs Submission:</b> Complied Noted and Compliance Report shall be updated on company's website.		Date: 29/11/2024
5	MISCELLANEOUS	The project proponent shall submit six-monthly reports on the status of the compliance of the stipulated environmental conditions on the website of the ministry of Environment, Forest and Climate Change at environment clearance portal.
<b>PPs Submission:</b> Agreed to Comply Noted, Six monthly compliance report shall be updated on the Parivesh Portal.		Date: 29/11/2024
6	MISCELLANEOUS	The criteria pollutant levels namely; PM2.5, PM10, SO2, NOx (ambient levels) or critical sectoral parameters, indicated for the project shall be monitored and displayed at a convenient location near the main gate of the company in the public domain.
<b>PPs Submission:</b> Being Complied Environment monitoring including the mentioned parameters are being monitored regularly and is displayed at main gate of the company.		Date: 29/11/2024
7	MISCELLANEOUS	The project proponent shall inform the Regional Office as well as the Ministry, the date of financial closure and final approval of the project by the concerned authorities, commencing the land



		development work and start of production operation by the project.
<b>PPs Submission:</b> Agreed to Comply Noted for compliance.		Date: 29/11/2024
8	MISCELLANEOUS	The project authorities must strictly adhere to the stipulations made by the State Pollution Control Board and the State Government.
<b>PPs Submission:</b> Agreed to Comply Noted and shall be complied.		Date: 29/11/2024
9	MISCELLANEOUS	The project proponent shall abide by all the commitments and recommendations made in the EIA/EMP report, commitment made during Public Hearing and also that during their presentation to the Expert Appraisal Committee.
<b>PPs Submission:</b> Agreed to Comply Noted and shall be complied. Public Hearing was exempted for the project		Date: 29/11/2024
10	MISCELLANEOUS	No further expansion or modifications in the project shall be carried out without prior approval of the Ministry of Environment, Forests and Climate Change (MoEF&CC).
<b>PPs Submission:</b> Agreed to Comply Noted for information.		Date: 29/11/2024
11	MISCELLANEOUS	Concealing factual data or submission of false/fabricated data may result in revocation of this environmental clearance and attract action under the provisions of Environment (Protection) Act, 1986.
<b>PPs Submission:</b> Agreed to Comply Noted for information.		Date: 29/11/2024
12	MISCELLANEOUS	The Ministry may revoke or suspend the clearance, if implementation of any of the above conditions is not satisfactory.
<b>PPs Submission:</b> Agreed to Comply Noted for information.		Date: 29/11/2024
13	MISCELLANEOUS	The Ministry reserves the right to stipulate additional conditions if found necessary. The Company in a time bound manner shall implement these conditions.
<b>PPs Submission:</b> Agreed to Comply Noted for information.		Date: 29/11/2024
14	MISCELLANEOUS	The Regional Office of this Ministry shall monitor compliance of the stipulated conditions. The project authorities should extend full cooperation to the officer (s) of the Regional Office by furnishing the requisite data / information/monitoring reports.
<b>PPs Submission:</b> Agreed to Comply Noted and required support shall be provided.		Date: 29/11/2024
15	MISCELLANEOUS	The above conditions shall be enforced, inter-alia under the

		provisions of the Water (Prevention & Control of Pollution) Act, 1974, the Air (Prevention & Control of Pollution) Act, 1981, the Environment (Protection) Act, 1986, Hazardous and Other Wastes (Management and Transboundary Movement) Rules, 2016 and the Public Liability Insurance Act, 1991 along with their amendments and Rules and any other orders passed by the Hon'ble Supreme Court of India / High Courts and any other Court of Law relating to the subject matter.
<b>PPs Submission:</b> Agreed to Comply Noted for information.		Date: 29/11/2024
16	MISCELLANEOUS	Any appeal against this EC shall lie with the National Green Tribunal, if preferred, within a period of 30 days as prescribed under Section 16 of the National Green Tribunal Act, 2010.
<b>PPs Submission:</b> Agreed to Comply Noted for information.		Date: 29/11/2024
17	Statutory compliance	Construction activity shall be carried out strictly according to the provisions of CRZ Notification, 2011 and the State Coastal Zone Management Plan as drawn up by the State Government. No construction work other than those permitted in Coastal Regulation Zone Notification shall be carried out in Coastal Regulation Zone area.
<b>PPs Submission:</b> Agreed to Comply Noted and no construction work other than that permitted in CRZ area shall be carried out.		Date: 29/11/2024
18	Statutory compliance	A certificate of adequacy of available power from the agency supplying power to the project along with the load allowed for the project should be obtained.
<b>PPs Submission:</b> Complied Existing power infrastructure is sufficient to cater the additional power required for this project.		Date: 29/11/2024
19	Statutory compliance	All other statutory clearances such as the approvals for storage of diesel from Chief Controller of Explosives, Fire Department, Coast Guard, Civil Aviation Department shall be obtained, as applicable by project proponents from the respective competent authorities.
<b>PPs Submission:</b> Complied No diesel storage is envisaged for the project		Date: 29/11/2024
20	AIR QUALITY MONITORING AND PRESERVATION	The project proponent shall install system to carryout Ambient Air Quality monitoring for common/criterion parameters relevant to the main pollutants released (e.g. PM10 and PM2.5 in reference to PM emission, and SO2 and NOx in reference to SO2 and NOx emissions) within and outside the project area at least at four locations, covering upwind and downwind directions.
<b>PPs Submission:</b> Complied The ambient air monitoring is being carried out on weekly basis in the four locations and is attached as Annexure -II .		Date: 29/11/2024
21	AIR QUALITY MONITORING AND	Appropriate Air Pollution Control (APC) system shall be provided for all the dust generating points including fugitive dust from all

	PRESERVATION	vulnerable sources, so as to comply prescribed emission standards.
<b>PPs Submission:</b> Agreed to Comply Noted and same shall be complied		Date: 29/11/2024
22	AIR QUALITY MONITORING AND PRESERVATION	Shrouding shall be carried out in the work site enclosing the dock/proposed facility area. This will act as dust curtain as well achieving zero dust discharge from the site. These curtain or shroud will be immensely effective in restricting disturbance from wind in affecting the dry dock operations, preventing waste dispersion, improving working conditions through provision of shade for the workers.
<b>PPs Submission:</b> Agreed to Comply Noted and same shall be complied		Date: 29/11/2024
23	AIR QUALITY MONITORING AND PRESERVATION	Dust collectors shall be deployed in all areas where blasting (surface cleaning) and painting operations are to be carried out, supplemented by stacks for effective dispersion.
<b>PPs Submission:</b> Agreed to Comply Noted and same shall be complied		Date: 29/11/2024
24	AIR QUALITY MONITORING AND PRESERVATION	The Vessels shall comply the emission norms prescribed from time to time.
<b>PPs Submission:</b> Agreed to Comply Noted and same shall be complied		Date: 29/11/2024
25	AIR QUALITY MONITORING AND PRESERVATION	Diesel power generating sets proposed as source of backup power should be of enclosed type and conform to rules made under the Environment (Protection) Act, 1986. The height of stack of DG sets should be equal to the height needed for the combined capacity of all proposed DG sets. Use of low sulphur diesel. The location of the DG sets may be decided with in consultation with State Pollution Control Board.
<b>PPs Submission:</b> Agreed to Comply Noted and same shall be complied		Date: 29/11/2024
26	AIR QUALITY MONITORING AND PRESERVATION	A detailed traffic management and traffic decongestion plan shall be drawn up to ensure that the current level of service of the roads within a 05 kms radius of the project is maintained and improved upon after the implementation of the project. This plan should be based on cumulative impact of all development and increased habitation being carried out or proposed to be carried out by the project or other agencies in this 05 Kms radius of the site in different scenarios of space and time and the traffic management plan shall be duly validated and certified by the State Urban Development department and the P.W.D./ competent authority for road augmentation and shall also have their consent to the implementation of components of the plan which involve the participation of these departments.
<b>PPs Submission:</b> Complied Traffic management study has been conducted covering the requirements and is attached as		Date: 29/11/2024

Annexure - III.		
27	WATER QUALITY MONITORING AND PRESERVATION	The Project proponent shall ensure that no creeks or rivers are blocked due to any activities at the project site and free flow of water is maintained.
<b>PPs Submission:</b> Complied The construction activities are limited to existing onshore land within the plant boundary and no creeks or rivers are blocked.		Date: 29/11/2024
28	WATER QUALITY MONITORING AND PRESERVATION	Appropriate measures must be taken while undertaking digging activities to avoid any likely degradation of water quality. Silt curtains shall be used to contain the spreading of suspended sediment during dredging within the dredging area.
<b>PPs Submission:</b> Agreed to Comply Digging activities shall be done carefully to avoid any degradation of water quality.		Date: 29/11/2024
29	Marine/Coastal	Dredging shall not be carried out during the fish breeding and spawning seasons.
<b>PPs Submission:</b> Complied No dredging is envisaged for the project		Date: 29/11/2024
30	Marine/Coastal	Dredging, etc shall be carried out in the confined manner to reduce the impacts on marine environment.
<b>PPs Submission:</b> Complied No dredging is envisaged for the project		Date: 29/11/2024
31	Marine/Coastal	The dredging schedule shall be so planned that the turbidity developed is dispersed soon enough to prevent any stress on the fish population.
<b>PPs Submission:</b> Complied No dredging is envisaged for the project		Date: 29/11/2024
32	Marine/Coastal	"While carrying out dredging, an independent monitoring shall be carried out through a Government Agency/Institute to assess the impact and necessary measures shall be taken on priority basis if any adverse impact is observed."
<b>PPs Submission:</b> Complied No dredging is envisaged for the project		Date: 29/11/2024
33	MISCELLANEOUS	The project proponent shall submit the environmental statement for each financial year in Form-V to the concerned State Pollution Control Board as prescribed under the Environment (Protection) Rules, 1986, as amended subsequently and put on the website of the company.
<b>PPs Submission:</b> Complied Form-V of the existing terminal is being submitted regularly.		Date: 29/11/2024
34	Marine/Coastal	A detailed marine biodiversity management plan shall be prepared through the NIO or any other institute of repute on marine, brackish

		water and fresh water ecology and biodiversity and submitted to and implemented to the satisfaction of the State Biodiversity Board and the CRZ authority. The report shall be based on a study of the impact of the project activities on the intertidal biotopes, corals and coral communities, molluscs, sea grasses, sea weeds, sub-tidal habitats, fishes, other marine and aquatic micro, macro and mega flora and fauna including benthos, plankton, turtles, birds etc. as also the productivity. The data collection and impact assessment shall be as per standards survey methods and include underwater photography.
<b>PPs Submission:</b> Complied "Marine Biodiversity study has been carried out as per the said requirement and Marine Biodiversity plan is in place and will be adhered too. Marine Biodiversity plan is attached as Annexure- V."		Date: 29/11/2024
35	Marine/Coastal	Marine ecology shall be monitored regularly also in terms of sea weeds, sea grasses, mudflats, sand dunes, fisheries, echinoderms, shrimps, turtles, corals, coastal vegetation, mangroves and other marine biodiversity components including all micro, macro and mega floral and faunal components of marine biodiversity.
<b>PPs Submission:</b> Being Complied Marine Ecology study is being carried out on six monthly basis and report of the same is attached as Annexure- I.		Date: 29/11/2024
36	Marine/Coastal	The project proponent shall ensure that water traffic does not impact the aquatic wildlife sanctuaries that fall along the stretch of the river.
<b>PPs Submission:</b> Complied No aquatic wildlife sanctuaries are in the vicinity of project site.		Date: 29/11/2024
37	Human Health Environment	The work space shall be maintained as per international standards for occupational health and safety with provision of fresh air respirators, blowers, and fans to prevent any accumulation and inhalation of undesirable levels of pollutants including VOCs.
<b>PPs Submission:</b> Complied Occupational health and safety standards are maintained during construction and operation phase to prevent any accumulation and inhalation of undesirable levels of pollutants		Date: 29/11/2024
38	Human Health Environment	Workers shall be strictly enforced to wear personal protective equipments like dust mask, ear muffs or ear plugs, whenever and wherever necessary/ required. Special visco-elastic gloves will be used by labour exposed to hazards from vibration.
<b>PPs Submission:</b> Complied PPE Compliance is being followed strictly at site as per the nature of the job.		Date: 29/11/2024
39	Human Health Environment	In case of repair of any old vessels, excessive care shall be taken while handling Asbestos & Freon gas. Besides, fully enclosed covering should be provided for the temporary storage of asbestos materials at site before disposal to CTSDf.
<b>PPs Submission:</b> Complied Old vessel repairing is not envisaged for the project		Date: 29/11/2024
40	Human Health Environment	Safety training shall be given to all workers specific to their work area and every worker and employee will be engaged in fire hazard

		awareness training and mock drills which will be conducted regularly. All standard safety and occupational hazard measures shall be implemented and monitored by the concerned officials to prevent the occurrence of untoward incidents.
<b>PPs Submission:</b> Complied Safety training is being provided to every workers on the day of joining and refresher trainings are also being conducted. Mock drills are conducted regularly inside plant and at project site.		Date: 29/11/2024
41	Human Health Environment	Emergency preparedness plan based on the Hazard identification and Risk Assessment (HIRA) and Disaster Management Plan shall be implemented.
<b>PPs Submission:</b> Complied Emergency Preparedness plan is in place and is followed in case of any emergencies.		Date: 29/11/2024
42	Human Health Environment	Provision shall be made for the housing of construction labour within the site with all necessary infrastructure and facilities such as fuel for cooking, mobile toilets, mobile STP, safe drinking water, medical health care, crèche etc. The housing may be in the form of temporary structures to be removed after the completion of the project.
<b>PPs Submission:</b> Complied Contract workers have a defined colony at designated place outside the site where all the required facilities are provided.		Date: 29/11/2024
43	Human Health Environment	Occupational health surveillance of the workers shall be done on a regular basis.
<b>PPs Submission:</b> Complied Occupational health checkup is being carried out for the contract workers on six monthly basis.		Date: 29/11/2024
44	Corporate Environmental Responsibility	The company shall have a well laid down environmental policy duly approved by the Board of Directors. The environmental policy should prescribe for standard operating procedures to have proper checks and balances and to bring into focus any infringements/deviation/violation of the environmental / forest /wildlife norms/ conditions. The company shall have defined system of reporting infringements / deviation / violation of the environmental / forest / wildlife norms / conditions and / or shareholders / stake holders. The copy of the board resolution in this regard shall be submitted to the MoEF&CC as a part of six-monthly report.
<b>PPs Submission:</b> Complied Company has a defined Health Safety and Environment (HSE) policy which is being adhered strictly. There is a defined system for reporting any violation related to environment related concerns.		Date: 29/11/2024
45	Corporate Environmental Responsibility	A separate Environmental Cell both at the project and company head quarter level, with qualified personnel shall be set up under the control of senior Executive, who will directly report to the head of the organization.
<b>PPs Submission:</b> Complied Defined Environment cell is in place and is attached as Annexure-VI.		Date: 29/11/2024
46	Corporate Environmental	Action plan for implementing EMP and environmental conditions

	Responsibility	along with responsibility matrix of the company shall be prepared and shall be duly approved by competent authority. The year wise funds earmarked for environmental protection measures shall be kept in separate account and not to be diverted for any other purpose. Year wise progress of implementation of action plan shall be reported to the Ministry/Regional Office along with the Six Monthly Compliance Report.
<b>PPs Submission:</b> Agreed to Comply Noted and shall be complied.		Date: 29/11/2024
47	Corporate Environmental Responsibility	Self environmental audit shall be conducted annually. Every three years third party environmental audit shall be carried out.
<b>PPs Submission:</b> Agreed to Comply Noted and Audit shall be carried out as per the schedule.		Date: 29/11/2024
48	WATER QUALITY MONITORING AND PRESERVATION	Measures should be taken to contain, control and recover the accidental spills of fuel and cargo handle.
<b>PPs Submission:</b> Agreed to Comply Noted and will be complied.		Date: 29/11/2024
49	WATER QUALITY MONITORING AND PRESERVATION	The project proponents will draw up and implement a plan for the management of temperature differences between intake waters and discharge waters.
<b>PPs Submission:</b> Agreed to Comply Noted and will be complied.		Date: 29/11/2024
50	WATER QUALITY MONITORING AND PRESERVATION	Spillage of fuel / engine oil and lubricants from the construction site are a source of organic pollution which impacts marine life. This shall be prevented by suitable precautions and also by providing necessary mechanisms to trap the spillage.
<b>PPs Submission:</b> Being Complied Adequate measures are being taken to prevent any spillage of oil at the source itself to prevent the marine life.		Date: 29/11/2024
51	WATER QUALITY MONITORING AND PRESERVATION	Total fresh water use shall not exceed the proposed requirement as provided in the project details. Prior permission from competent authority shall be obtained for use of fresh water.
<b>PPs Submission:</b> Agreed to Comply Noted and same shall be ensured that total freshwater usage doesn't exceed the proposed requirement.		Date: 29/11/2024
52	WATER QUALITY MONITORING AND PRESERVATION	Sewage Treatment Plant shall be provided to treat the wastewater generated from the project. Treated water shall be reused for horticulture, flushing, backwash, HVAC purposes and dust suppression.
<b>PPs Submission:</b> Complied STP is in place and treated water from STP is being used in horticulture, dust suppression, etc.		Date: 29/11/2024
53	WATER QUALITY	A certificate from the competent authority for discharging treated

	MONITORING AND PRESERVATION	effluent/ untreated effluents into the Public sewer/ disposal/drainage systems along with the final disposal point should be obtained.
<b>PPs Submission:</b> Complied No effluent/untreated effluents are being discharged into the public sewer/drainage system and same is being ensured.		Date: 29/11/2024
54	WATER QUALITY MONITORING AND PRESERVATION	No diversion of the natural course of the river shall be made without prior permission from the Ministry of Water resources.
<b>PPs Submission:</b> Agreed to Comply Noted and same shall be ensured.		Date: 29/11/2024
55	WATER QUALITY MONITORING AND PRESERVATION	All the erosion control measures shall be taken at water front facilities. Earth protection work shall be carried out to avoid erosion of soil from the shoreline/boundary line from the land area into the marine water body.
<b>PPs Submission:</b> Complied The construction activities are limited to existing onshore land within the plant boundary and no erosion is envisaged		Date: 29/11/2024
56	Noise Monitoring & Prevention	Noise level survey shall be carried as per the prescribed guidelines and report in this regard shall be submitted to Regional Officer of the Ministry as a part of six-monthly compliance report.
<b>PPs Submission:</b> Being Complied The ambient noise monitoring is being carried out on weekly basis in the four locations and is attached as Annexure -II .		Date: 29/11/2024
57	Noise Monitoring & Prevention	Noise from vehicles, power machinery and equipment on-site should not exceed the prescribed limit. Equipment should be regularly serviced. Attention should also be given to muffler maintenance and enclosure of noisy equipments.
<b>PPs Submission:</b> Agreed to Comply Noted and shall be ensured.		Date: 29/11/2024
58	Noise Monitoring & Prevention	Acoustic enclosures for DG sets, noise barriers for ground-run bays, ear plugs for operating personnel shall be implemented as mitigation measures for noise impact due to ground sources.
<b>PPs Submission:</b> Agreed to Comply Noted and shall be ensured.		Date: 29/11/2024
59	Noise Monitoring & Prevention	The ambient noise levels should conform to the standards prescribed under E(P)A Rules, 1986 viz. 75 dB(A) during day time and 70 dB(A) during night time.
<b>PPs Submission:</b> Complied The ambient noise monitoring is being carried out on weekly basis in the four locations and is attached as Annexure -II .		Date: 29/11/2024
60	ENERGY PRESERVATION MEASURES	Provide solar power generation on roof tops of buildings, for solar light system for all common areas, street lights, parking around project area and maintain the same regularly;



<b>PPs Submission:</b> Agreed to Comply Noted and same is being complied.		Date: 29/11/2024
61	ENERGY PRESERVATION MEASURES	Provide LED lights in offices and project areas.
<b>PPs Submission:</b> Agreed to Comply Noted and same is being complied		Date: 29/11/2024
62	WASTE MANAGEMENT	Dredged material shall be disposed safely in the designated areas.
<b>PPs Submission:</b> Complied Dredging is not envisaged in this project.		Date: 29/11/2024
63	WASTE MANAGEMENT	Shoreline should not be disturbed due to dumping. Periodical study on shore line changes shall be conducted and mitigation carried out, if necessary. The details shall be submitted along with the six monthly monitoring reports.
<b>PPs Submission:</b> Complied The construction activities are limited to existing onshore land within the plant boundary and shoreline will not be disturbed.		Date: 29/11/2024
64	WASTE MANAGEMENT	Necessary arrangements for the treatment of the effluents and solid wastes must be made and it must be ensured that they conform to the standards laid down by the competent authorities including the Central or State Pollution Control Board and under the Environment (Protection) Act, 1986.
<b>PPs Submission:</b> Agreed to Comply Noted and will be complied. Solid waste and effluents will be disposed as per regulatory guidelines only.		Date: 29/11/2024
65	WASTE MANAGEMENT	The solid wastes shall be managed and disposed as per the norms of the Solid Waste Management Rules, 2016.
<b>PPs Submission:</b> Agreed to Comply Noted and shall be complied.		Date: 29/11/2024
66	WASTE MANAGEMENT	Any wastes from construction and demolition activities related thereto shall be managed so as to strictly conform to the Construction and Demolition Waste Management Rules, 2016.
<b>PPs Submission:</b> Complied Construction debris generated at site is being reused at site only.		Date: 29/11/2024
67	WASTE MANAGEMENT	A certificate from the competent authority handling municipal solid wastes should be obtained, indicating the existing civic capacities of handling and their adequacy to cater to the M.S.W. generated from project.
<b>PPs Submission:</b> Agreed to Comply Noted and same shall be complied.		Date: 29/11/2024
68	WASTE MANAGEMENT	Used CFLs and TFLs should be properly collected and disposed off/sent for recycling as per the prevailing guidelines/ rules of the

		regulatory authority to avoid mercury contamination.
<b>PPs Submission:</b> Agreed to Comply Noted and same shall be complied		<b>Date:</b> 29/11/2024
69	WASTE MANAGEMENT	Oil spill contingency plan shall be prepared and part of DMP to tackle emergencies. The equipment and recovery of oil from a spill would be assessed. Guidelines given in MARPOL and Shipping Acts for oil spill management would be followed. Mechanism for integration of terminals oil contingency plan with the overall area contingency plan under the co-ordination of Coast should be covered.
<b>PPs Submission:</b> Complied Oil Spill Contingency Plan is in place and is attached as Annexure-IV.		<b>Date:</b> 29/11/2024
70	GREENBELT	Green belt shall be developed in area as provided in project details with a native tree species in accordance with CPCB guidelines.
<b>PPs Submission:</b> Agreed to Comply Noted and Green Belt will be developed in accordance with CBCB guidelines.		<b>Date:</b> 29/11/2024
71	GREENBELT	Top soil shall be separately stored and used in the development of green belt.
<b>PPs Submission:</b> Agreed to Comply Noted and shall be complied.		<b>Date:</b> 29/11/2024
<b>Visit Remarks</b>		
<b>Last Site Visit Report Date:</b>		N/A
<b>Additional Remarks:</b>		
<p style="color: red; text-align: center;"><b>Note:</b> This acknowledgement is as per the details submitted by project proponent. In no way is this document to be considered as conclusion on any action on the compliance of the project. This is strictly for the project proponent's reference purpose.</p>		

# MARINE ECOLOGICAL MONITORING REPORT

FOR

**M/s.PETRONET LNG LIMITED., DAHEJ**

DECEMBER 2023



PREPARED BY: M/S.UNISTAR ENVIRONMENT AND RESEARCH LABS PVT. LTD.

---

## PREFACE

The Company had set up South East Asia's first LNG Receiving and Regasification Terminal with an original nameplate capacity of 5 MMTPA at Dahej, Gujarat. The infrastructure was developed in the shortest possible time and at a benchmark cost. The capacity of the terminal has been expanded in phases which is currently 17.5 MMTPA and the same is under expansion to 22.5 MMTPA in two phases. The terminal has 6 LNG storage tanks and other vaporization facilities. The terminal is meeting around 40% of the total gas demand of the country.

The terminal has two LNG Jetties at Dahej. While the first jetty can handle berthing of up to Q-Flex vessels, the second jetty can handle berthing of up to Q-Max vessels.

Dahej terminal is the largest single location LNG storage and regasification terminal in the country and has recently achieved the milestone of handling 3000th LNG cargo on 7th July 2022. The terminal is also offering tolling services to Off takers & Bulk customers. To cater the small customers who are not having gas pipeline connectivity, Dahej is supplying LNG to such customers which is transported through cryogenic trucks.

PLL Dahej is first terminal to start loading of LNG in trucks for supply of LNG to the areas where pipelines have not reached and today has 04 truck loading bays and hub for development of Small-Scale LNG business. PPL has entrusted the work of carrying out Marine Ecological Monitoring to **M/s.UniStar Environment and Research Labs Pvt. Ltd.**

These Marine Ecological Monitoring reports provide a data obtained from monitoring and analysis activities undertaken on dated.26.12.2023. (December-2023)

Date: 29/12/2023

**M/s.UniStar Environment and Research Labs Pvt. Ltd.**

White house, Char Rasta, Vapi-396 191

Approved by

**Manager - Operations**  
(Jaivik Tandel)

### TABLE OF CONTENTS

NO.	Contents	Page No.
<b>Introduction To Project</b>		4
1.1	Background	4
1.2	Objectives	4
1.3	Scope of Work	4
1.4	Sampling Strategy	5
1.5	Team Members	7
<b>Water Quality</b>		8
2.1	Marine Water quality	8
2.2	Physico-chemical Water analysis result	9
<b>Biological Characteristics (Biodiversity Studies)</b>		11
3.1	Planktonic forms	11
3.2	Zooplankton Diversity	12
3.3	Macro-Benthic Fauna	16
3.4	Benthic Diversity	17
3.5	Avifaunal Diversity	21
3.6	Mangroves	22
3.7	Phytoplankton Diversity	23
3.8	Phytoplankton Pigments (Chlorophyll A And Pheophytin)	31
3.9	Chlorophyll A And Pheophytin Concentrations	31
4.0	Conclusion	33
<b>Map / Photos / Images/Graph</b>		
1	Sampling locations of Subtidal and intertidal Zone at M/s. PLL., Dahej Terminals	6
2	Zooplankton population in the sub-tidal waters	14
3	Zooplankton population in the inter-tidal waters	15
4	Dominant groups of Zooplankton	15
5	Microphotographs of zooplanktons	16
6	Subtidal macro benthos abundance (nos./m <sup>2</sup> ) during high tide and low tide	18
7	Inter-tidal macro benthos abundance	20
8	Percent composition of Subtidal benthic taxa from the marine waters	20
9	Microphotographs of microbenthic organisms	21
10	High Tidal Level (HTL) phytoplankton abundance (no. x10 <sup>2</sup> / L)	26

NO.	Contents	Page No.
11	Low Tidal Level (LTL) phytoplankton abundance (no. $\times 10^2$ / L)	28
12	Inter-tidal phytoplankton abundance (no. $\times 10^2$ / L)	30
13	Microphotographs of phytoplankton	30
14	Sampling Photographs	36
<b>Tables</b>		
1	Co-ordinates of subtidal and intertidal sampling stations	5
2	Methodology of Physico chemical Water Analysis	8
3	Physico-Chemical Water Analysis Results	9-10
4	Test methods for phytoplankton, Zooplankton, Chlorophyll a and Pheophytin, Macro benthos analysis	12
5	Population (nos./100 m <sup>3</sup> ) and biomass (ml/100 m <sup>3</sup> ) of various zooplankton groups in the sub-tidal area	13
6	Population (nos./100 m <sup>3</sup> ) and biomass (ml/100 m <sup>3</sup> ) of various zooplankton groups in the inter-tidal area	14
7	Faunal composition, density (nos./m <sup>2</sup> ) and biomass (g/m <sup>2</sup> ) of the macro benthos community in the sub-tidal region	18
8	Faunal composition, density (nos./m <sup>2</sup> ) and biomass (g/m <sup>2</sup> ) of the macrobenthos community in the inter-tidal region	19
9	List of bird species observed in the study area.	22
10	Phytoplankton abundance (cells $\times 10^2$ /L) at different sampling stations during High Tide Level (HTL) in the coastal waters	25
11	Phytoplankton abundance (cells $\times 10^2$ /L) at different sampling stations during Low Tide Level (LTL) in the coastal waters	27
12	Phytoplankton abundance (cells $\times 10^2$ /L) at different sampling stations during Intertidal zone	29
13	Chlorophyll a, Pheophytin concentrations in the surface marine water at High Tide level (HTL) and Inert-tidal zone (IT)	32
14	Chlorophyll a, Pheophytin concentrations in the middle marine water at High Tide level (HTL)	32
15	Chlorophyll a, Pheophytin concentrations in the bottom marine water at High Tide level (HTL)	32
16	Chlorophyll a, Pheophytin concentrations in the surface marine water at Low Tide level (LTL)	32
17	Chlorophyll a, Pheophytin concentrations in the middle marine water at Low Tide level (LTL)	33
18	Chlorophyll a, Pheophytin concentrations in the bottom marine water at Low Tide level (LTL)	33

## ❖ INTRODUCTION

### 1.1 Background:

The Marine Ecological Monitoring involves Physico-chemical and biological analysis of Marine water. Marine water quality of Sub-tidal and Intertidal regions, Flora and Fauna analysis in marine water area and Benthos in inter-tidal and sub-tidal analysis for the Petronet LNG Ltd. (Dahej LNG Terminal). Water sample are collected from different location (station) and Benthos sample are collected from High water and low water transect area. Samples are brought to the laboratory by field sampling team and the analysis was carried out in our laboratory and the results are presented in this report.

### 1.2 Objectives:

The primary objectives of this study are,

- a) To evaluate the physico-chemical parameters of seawater for better understanding of water quality in study region.
- b) To assess the marine biological status of the study region with quantitative and qualitative data of marine organisms (phytoplankton, zooplankton, and macrobenthos).
- c) To recommend adequate marine environmental management measures.

### 1.3 Scope of work

Sample collection on spatial basis for the Petronet LNG Ltd. (Dahej LNG Terminal) to evaluate the following parameters:

#### a) Marine Biological Water quality sample analysis from subtidal region

Water quality will be assessed for Temperature, pH, Turbidity, Total suspended solids, salinity, Oil & grease, Dissolved Oxygen (DO), Biochemical Oxygen Demand (BOD), Calcium Carbonate, Alkalinity, Petroleum Hydrocarbons (PHC), Total Phosphate, Nitrate, Ammonical nitrogen, Total nitrogen and Total coliform.

#### b) Biological Analysis of collected sample with respect to phytoplankton, zooplankton, Chlorophyll from subtidal region

#### c) Sampling of benthic communities from subtidal region between Low tide and high tide

d) Intertidal flora/fauna Qualitative and quantitative estimations: phytoplankton, pollution and generic diversity, primary productivity, zooplankton standing stock, microbenthic standing stock subtidal region, sea grass, algae, sea weeds, crustaceans, fishes mangroves and migratory birds etc.

#### 1.4 Sampling strategy

To evaluate the influence of activity at the Petronet LNG Ltd. (Dahej LNG Terminal), sedimentary parameters and marine biota present sampling was carried out on dated.09.06.2023

**Table 1: Co-ordinates of subtidal and intertidal sampling stations**

Stations		Co-ordinates			
Sub-tidal (ST)	ST-1	HTL	21°40.880'N	72°29.807'E	
		LTL	21°40.887'N	72°29.948'E	
	ST-2	HTL	21°39.867'N	72°29.799'E	
		LTL	21°39.880'N	72°29.790'E	
	ST-3	HTL	21°39.100'N	72°29.800'E	
		LTL	21°39.055'N	72°29.801'E	
	ST-4	HTL	21°38.130'N	72°30.432'E	
		LTL	21°38.020'N	72°30.587'E	
	Intertidal (IT)	IT-01		21°40.572'N	72°30.921'E
		IT-02		21°40.559'N	72°30.586'E
		IT-03		21°40.128'N	72°30.950'E
		IT-04		21°39.896'N	72°30.629'E

#### a) Sampling frequency:

All Sampling subtidal stations were monitored during flood to ebb. Water samples were collected in Triplicate (surface, Middle and bottom) for assessing water quality and marine biological characteristics.

Intertidal sampling was completed during low tide, for assessed Macro benthic fauna samples were collect in duplicate from each transects.



**Figure 1. Sampling locations of Subtidal and intertidal at M/s.Petronet LNG Limited., Dahej Terminals**



**b) Sampling methodology:**

- **Water quality:** Surface water samples were collected using the clean polyethylene bucket. Niskin water sampler (5-liter capacity) with a mechanism for closing at a desired depth using messenger was used for collecting sub-surface (bottom) water samples (~1m above the sea floor).
- **Sediment sampling:** For estimation of sedimentary parameters samples were collected from subtidal stations using Van-Veen type grab (area of 0.1 m<sup>2</sup>), while intertidal samples were collected using metal quadrant (0.25 m<sup>2</sup> area).
- **Biological characteristics:** Samples for chlorophyll and phytoplanktons were collected using clean plastic bucket and Niskin water samples. The samples for chlorophyll were immediately preserved with ice and kept in ice box till further analysis whereas the phytoplankton samples were fixed with Lugol's iodine and few drops of 3% buffered formaldehyde solutions, while for zooplankton oblique hauls were made at water surface using Heron Tranter net (mesh size 0.20 mm, mouth area 0.05 m<sup>2</sup>) attached with calibrated flow meter (General Oceanic). The samples were preserved in 5% buffered formaldehyde solutions. Samples for macrobenthos were collected using Van-Veen type of grab covering an area of 0.1 m<sup>2</sup> and sieving through 500 µm mesh size. The samples were preserved with 5% formaldehyde Rose Bengal solutions.

### 1.5 Team Members

This Marine Ecological Monitoring work presented in this report is done by M/s. UniStar Environment and Research Labs Pvt. Ltd. With active co-operation from M/s. Petronet LNG Ltd. for this Marine Ecological Sampling and Analysis UERL team members as follows.

➤ **Sampling team members:**

1. Dr. Sushant Vilas Sanaye (Marine Scientist)
2. Mr. Bhavin Patel (Environmental Engineer)
3. Mr. Pravin Singh (Environmental Engineer)
4. Mr. Vijay Thanki (Environmental Chemist)

➤ **Laboratory members**

1. Dr. Ashwini Pawar-Sanaye, (Marine Scientist)
2. Dr. Sushant Vilas Sanaye (Marine Scientist)
3. Ms. Shweta A. Rana (Sr. Microbiologist)
4. Mr. Nilesh Patel (Sr. Chemist)

## ❖ WATER QUALITY

### 2.1 Marine Water quality:

Seawater samples have been collected during December 2023.

### 2.2 Physico chemical Water analysis result:

All the water sampled, which is collected by sampling team is brought to the lab for Physico chemical analysis. The marine water quality at different collected stations are measured during this investigation is presented in Table No.2.1 and its method of analysis is present in Table No.2.0

**Table: 2.0 Methodology of Physico chemical Water Analysis**

Sr.No.	Parameters	Test Method
1	pH @ 25 °C	IS 3025 (Part 11)1983
2	Temperature (°C)	IS 3025 (Part 9)1984
3	Turbidity	IS 3025 (Part 10)1984
4	Total Suspended Solids	APHA 23 <sup>rd</sup> Ed.,2017,2540- D
<b>CHEMICAL QUALITY</b>		
1	Biochemical Oxygen Demand (BOD)	IS 3025 (Part 44)1993
2	Oil & Grease	IS 3025 (Part 39) 2021
3	Ammonical Nitrogen	APHA 23 <sup>rd</sup> Ed.,2017,4500- NH <sub>3</sub> B
4	Salinity	By Calculation
5	Dissolved Oxygen	APHA 23 <sup>rd</sup> Ed.,2017,4500-O, B
6	Total Alkalinity as CaCO <sub>3</sub>	IS 3025 (Part 23)1986
7	Phosphate	APHA 23 <sup>rd</sup> Ed.,2017,4500-P, D
8	Nitrate	APHA 23 <sup>rd</sup> Ed.,2017,4500 NO <sub>3</sub> -B
9	Calcium Carbonate	APHA 23 <sup>rd</sup> Ed.,2017,3500 Ca. B
10	Petroleum Hydrocarbon (PHc)	GC Method
<b>MICROBIOLOGY QUALITY</b>		
1	Total Coliform	APHA 23 <sup>rd</sup> Ed.2017,9222-B

**Table: 2.1 Physico chemical Water Analysis Result**

Sr.No.	Parameters	Unit	Station 1			Station 2		
			Surface	Middle	Bottom	Surface	Middle	Bottom
<b>PHYSICAL QUALITY</b>								
1.	pH @ 25 °C	--	7.96	7.94	8.0	8.06	7.96	7.87
2.	Temperature	(°C)	28	28	28	28.3	28.3	28.3
3.	Turbidity	NTU	10	10	10	10	10	10
4.	Total Suspended Solids	(mg/l)	216	209	196	238	221	202
<b>CHEMICAL QUALITY</b>								
1.	Biochemical Oxygen Demand	mg/L	3.9	3.3	3.0	3.7	3.5	3.1
2.	Oil & Grease	mg/L	BDL (MDL:5.0)	BDL (MDL:5.0)	BDL (MDL:5.0)	BDL (MDL:5.0)	BDL (MDL:5.0)	BDL (MDL:5.0)
3.	Ammonical Nitrogen	mg/L	BDL (MDL:2.0)	BDL (MDL:2.0)	BDL (MDL:2.0)	BDL (MDL:2.0)	BDL (MDL:2.0)	BDL (MDL:2.0)
4.	Salinity	ppt	26.8	29.4	28.53	29.4	26.8	26.26
5.	Dissolved Oxygen	mg/L	6.5	6.4	6.2	6.3	6.2	6.1
6.	Total Alkalinity as CaCO <sub>3</sub>	mg/L	145.7	140.7	140.7	125.6	135.7	145.7
7.	Phosphate	mg/L	0.14	0.11	BDL (MDL:0.1)	BDL (MDL:0.1)	0.14	0.011
8.	Nitrate	mg/L	0.8	0.6	0.7	0.6	0.8	0.6
9.	Calcium Carbonate	mg/L	752	741.2	814.3	761.2	733.4	725.2
10.	Petroleum Hydrocarbon (PHc)	ppb	N.D.	N.D.	N.D.	N.D.	N.D.	N.D.
<b>MICROBIOLOGY QUALITY</b>								
1.	Total Coliform	CFU/100ml	66	18	Absent	58	21	Absent

**Note:** MDL = Minimum Detection Limit (MDL: 0.01) and N.D. = Not detectable

**Table: 2.2 Physico chemical Water Analysis Result**

Sr.No.	Parameters	Unit	Station 3			Station 4		
			Surface	Middle	Bottom	Surface	Middle	Bottom
<b>PHYSICAL QUALITY</b>								
1.	pH @ 25 °C	--	7.93	7.94	8.06	7.92	7.82	7.93
2.	Temperature	(°C)	28	28	28	28	28	28
3.	Turbidity	NTU	5	5	5	10	10	10
4.	Total Suspended Solids	(mg/l)	255	221	210	238	221	210
<b>CHEMICAL QUALITY</b>								
1.	Biochemical Oxygen Demand	mg/L	3.4	3.6	3.2	3.5	3.7	3.1
2.	Oil & Grease	mg/L	BDL (MDL:5.0)	BDL (MDL:5.0)	BDL (MDL:5.0)	BDL (MDL:5.0)	BDL (MDL:5.0)	BDL (MDL:5.0)
3.	Ammonical Nitrogen	mg/L	BDL (MDL:2.0)	BDL (MDL:2.0)	BDL (MDL:2.0)	BDL (MDL:2.0)	BDL (MDL:2.0)	BDL (MDL:2.0)
4.	Salinity	ppt	27.67	29.4	24.05	30.26	28.53	30.26
5.	Dissolved Oxygen	mg/L	6.4	6.5	6.3	6.6	6.5	6.4
6.	Total Alkalinity as CaCO <sub>3</sub>	mg/L	140.7	135.7	145.7	135.7	150.8	150.8
7.	Phosphate	mg/L	0.13	0.14	BDL (MDL:0.1)	0.11	BDL (MDL:0.1)	0.13
8.	Nitrate	mg/L	0.5	0.9	0.6	0.7	0.6	0.9
9.	Calcium Carbonate	mg/L	722.6	720.1	734.2	743.2	738.4	728.6
10.	Petroleum Hydrocarbon (PHc)	ppb	N.D.	N.D.	N.D.	N.D.	N.D.	N.D.
<b>MICROBIOLOGY QUALITY</b>								
1.	Total Coliform	CFU/100ml	66	28	Absent	52	14	Absent

**Note:** MDL = Minimum Detection Limit (MDL: 0.01) and N.D. = Not detectable

### ❖ **BIOLOGICAL CHARACTERISTICS (BIODIVERSITY STUDIES):**

Marine ecosystems are subject to a multitude of direct human pressures, such as overexploitation, eutrophication, pollution, and species introductions. These stressors can have synergistic effects on marine ecosystems, altering its functioning. Anthropogenic involvements constantly compromise the health of the marine ecosystem by disturbing the ecological balance. Hence the assessment of the biotic components along with abiotic factors is an integral part of environmental assessment and monitoring study. During the present investigation at Petronet LNG, Dahej, the abundance and distribution of marine organisms (Plankton and benthos) were studied as part of routine environmental monitoring.

#### **3.1 Planktonic Forms:**

The name plankton is derived from the Greek word “planktons”, meaning “wanderer” or “drifter”. While some forms of plankton are capable of independent movement and can swim up to several hundred meters in a single day, their position is primarily determined by currents and light in the body of water they inhabit. As per definition, organisms classified as "plankton" are unable to resist ocean currents. Plankton is primarily divided into two broad functional groups i.e., Phytoplankton and Zooplankton.

##### **3.1.1 Phytoplankton**

Phytoplankton are microscopic, single-celled photosynthetic organisms that live suspended in all water niches, including oceans, freshwater, and marine niche. Like the terrestrial ecosystem where plants are an integral part of the ecosystem, phytoplankton play key role in the biogeochemistry of the oceans. As they are dependent on sunlight for energy, they mostly inhabit the euphotic zone. Therefore, they are responsible for production of half of the atmosphere's oxygen and more than half of the primary production in the oceans. There are many species of phytoplankton, each of which has a characteristic shape, size, and function. Marine species of phytoplankton grow abundantly in oceans around the world and are the foundation of the marine food chain. Marine phytoplankton are the producing (autotrophic) component in the ocean. There are fourteen classes of phytoplankton. Each class of phytoplankton contains unique attributes in size, cell structure, nutrients, and function.

##### **3.1.2 Zooplankton:**

Zooplankton occupies second position in the food web of the marine niche. They are the primary consumer's organisms and generally feed on phytoplankton or small, microscopic group of organisms for they are nutritional needs. They are incapable of making their own food from sun-light or inorganic compounds, and feed on organisms or the remains of other organisms to get the energy necessary for survival.

## • SIGNIFICANCE OF PHYTO- AND ZOOPLANKTONS

Phytoplankton are vital to marine ecosystems. They are producers, or autotrophs, that form the foundation of most marine food webs. As photosynthetic organisms, they can convert solar energy into chemical energy and store it in form of sugars. They are responsible for half of the photosynthetic activity on the planet. The significance of zooplanktons is found in their role of transferring biological production from phytoplankton to large organisms in the marine food web and the seafloor. The microscopic protozoan, tunicates, copepods, and other crustaceans graze upon many phytoplankton species. These in turn become food for other animals further linking the food web. Therefore, variability in reproduction of copepods would affect the survival of young fish that feeds on them.

**Table 3: Test methods for phytoplankton, Zooplankton, Chlorophyll a and Pheophytin, Macro benthos analysis**

Sr. no.	Test performed	Method
1	Phytoplankton	APHA, Edition 23, Part 10000, 10200 F
2	Chlorophyll <i>a</i> and Pheophytin	APHA, Edition 23, Part 10000, 10200 H (with some modification)
3	Zooplankton	APHA, Edition 23, Part 10000, 10200 G
4	Macro benthos	APHA, Edition 23, Part 10000,10500 A-10500 D

### 3.2 ZOOPLANKTON DIVERSITY

Zooplankton includes arrays of organisms, varying in size from the microscopic protozoans of a few microns to some jellyfish-like organisms with tentacles several meters long. By virtue of sheer abundance and intermediate role between phytoplankton and fish, zooplankton is considered as the chief index of the utilization of aquatic biotopes at the second trophic level.

Zooplankton standing stock in terms of population and biomass revealed substantial variation within all Subtidal (4 stations) and inter-tidal (4 stations) stations (Table 4 and Table 5) in the study area of Petronet LNG jetty, Dahej during December 2023. In the sub-tidal area, the maximum zooplankton population density (21847 nos./100 m<sup>3</sup>) and biomass (3.98 ml/ 100 m<sup>3</sup>) was recorded at Station 1 during high tide level and minimum zooplankton population density (11199 nos./100 m<sup>3</sup>) and biomass (1.48 ml/100 m<sup>3</sup>) were recorded at Station 2 during low tide level (Figure 1). In the inter-tidal area, the maximum zooplankton population density (14209 nos./100 m<sup>3</sup>) and biomass (2.04 ml/100 m<sup>3</sup>) were recorded at Station IT-4 and the minimum zooplankton population (11110 nos./100 m<sup>3</sup>) and biomass (1.12 ml/100 m<sup>3</sup>) were recorded at Station IT-2 (Figure 2). A total of 12 groups of zooplankton including

Copepods, Copepod nauplii, crab larvae, Chaetognaths, Decapod larvae, fish and shellfish eggs, fish larvae, gastropod larvae, Polychaetae larvae, Siphonophora, Ostracods and Oikopleura were identified during this study (Table 4 and 5). Among these identified groups Copepods (80.09%) and Copepod nauplii (12.16%) were most dominant (Figure 3). Chaetognaths (3.72%) and Crab larvae (3.66%) were also the dominant groups in the zooplankton population (Figure 3). As well as fish and shell eggs, polychaetae larvae also were another observed group during the present study.

**Table 4: Population (nos./100 m<sup>3</sup>) and biomass (ml/100 m<sup>3</sup>) of various zooplankton groups in the sub-tidal area at the Petronet LNG, Dahej during December 2023.**

Zooplankton Groups	High Tide level				Low Tide level			
	St-1	St-2	St-3	St-4	St-1	St-2	St-3	St-4
Copepods	14923	14753	13808	15227	9634	8318	8267	11794
Copepod nauplii	3382	3264	2997	2998	1635	936	722	765
Crab larvae	837	1000	749	771	365	422	309	392
Chaetognaths	1185	736	642	514	452	386	536	485
Decapod (shrimps)	105	75	107	51	17	37	62	56
Fish and shell fish eggs	366	641	392	343	122	202	186	187
Fish larvae	0	19	36	17	0	0	21	0
Gastropod larvae	70	57	54	34	70	92	41	37
Polychaete larvae	314	377	375	411	157	110	392	37
Siphonophora	70	113	125	120	70	55	82	56
Ostracods	0	57	54	69	17	18	82	37
Oikopleura	70	38	143	51	17	55	103	19
<b>Population (nos./100 m<sup>3</sup>)</b>	<b>21874</b>	<b>21663</b>	<b>20601</b>	<b>20353</b>	<b>12880</b>	<b>11199</b>	<b>11240</b>	<b>13165</b>
<b>Biomass (ml./100 m<sup>3</sup>)</b>	<b>3.98</b>	<b>2.55</b>	<b>1.76</b>	<b>3.46</b>	<b>1.76</b>	<b>1.48</b>	<b>1.79</b>	<b>1.97</b>



**Table 5: Population (nos./100 m<sup>3</sup>) and biomass (ml/100 m<sup>3</sup>) of various zooplankton groups in the inter-tidal area at the Petronet LNG, Dahej during December 2023.**

Zooplankton Groups	Inter tidal stations			
	IT-1	IT-2	IT-3	IT-4
Copepods	11181	9958	9647	11367
Copepod nauplii	1371	1042	1050	813
Crab larvae	334	371	331	467
Chaetognaths	318	494	370	363
Decapod (shrimps)	17	18	39	35
Fish and shell fish eggs	134	159	195	190
Fish larvae	17	0	0	17
Gastropod larvae	17	0	58	35
Polychaete larvae	100	124	136	69
Siphonophora	67	106	58	87
Ostracods	50	18	58	35
Oikopleura	17	18	39	17
<b>Population (nos./100 m<sup>3</sup>)</b>	<b>11740</b>	<b>11110</b>	<b>11915</b>	<b>14209</b>
<b>Biomass (ml./100 m<sup>3</sup>)</b>	<b>1.56</b>	<b>1.12</b>	<b>1.92</b>	<b>2.04</b>

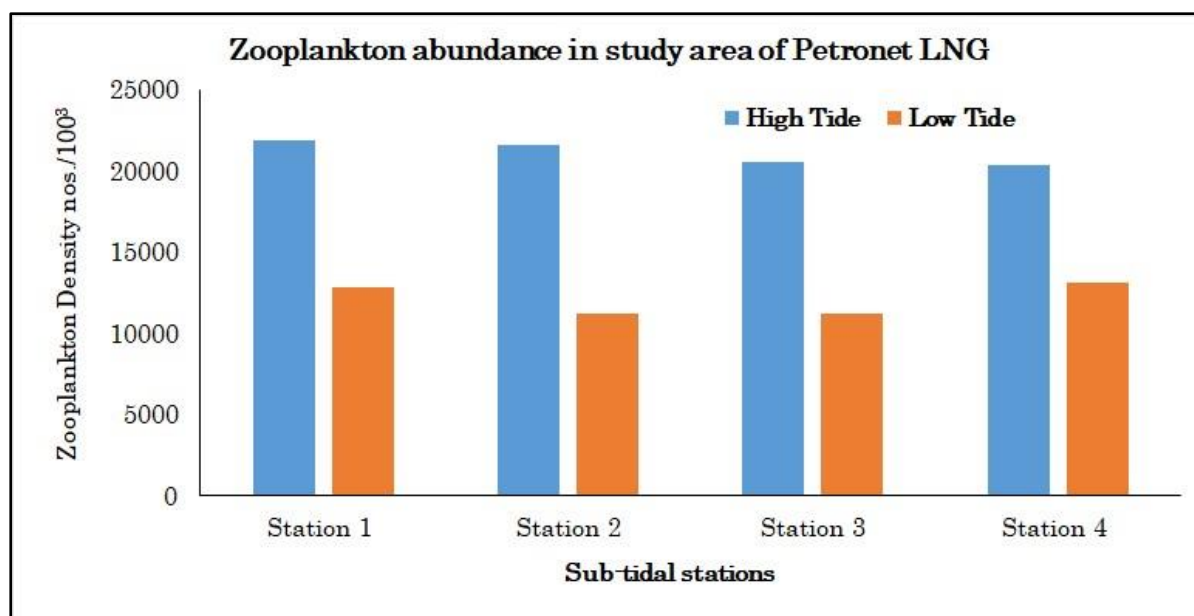

**Figure 1: Zooplankton population (nos./100 m<sup>3</sup>) recorded in the sub-tidal waters along the Petronet LNG, Dahej during December 2023.**

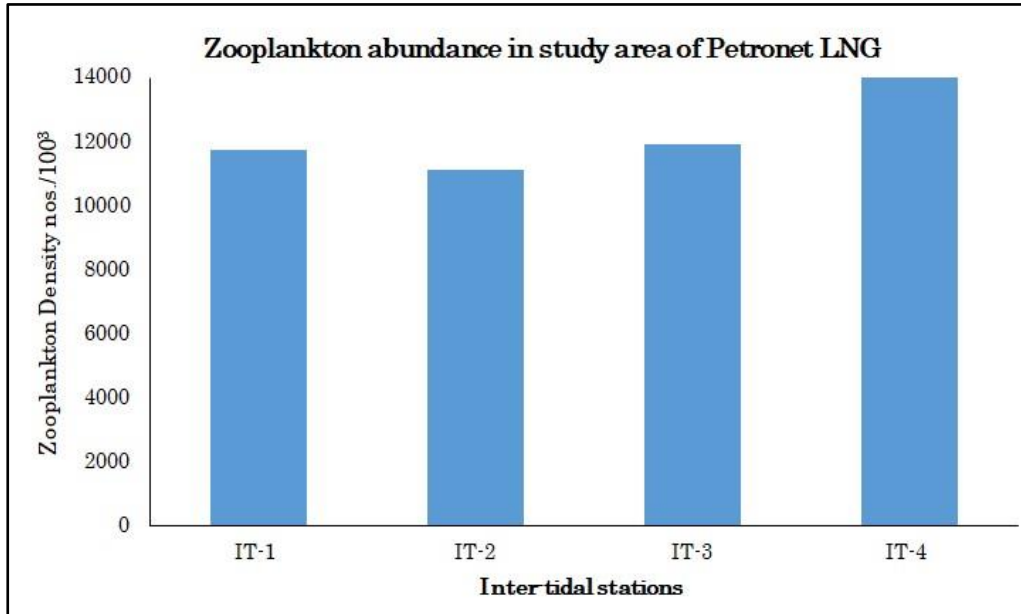

Figure 2: Zooplankton population (nos./100 m<sup>3</sup>) recorded in the inter-tidal waters along the Petronet LNG, Dahej during December 2023.

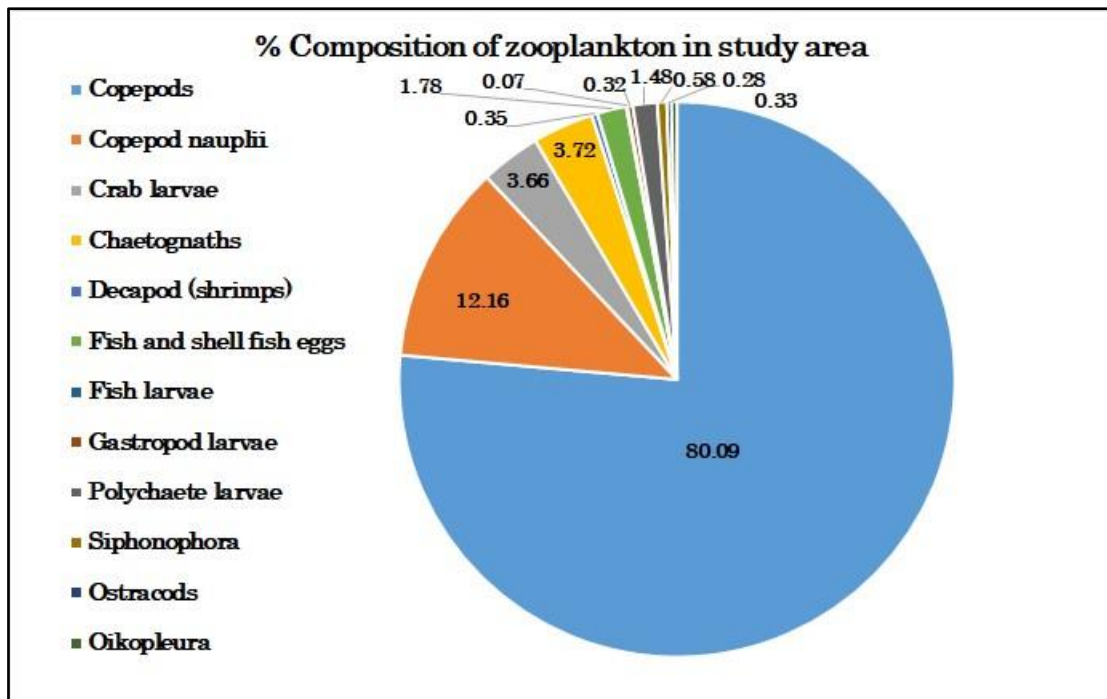

Figure 3: Dominant groups of Zooplankton reported from study area of Petronet LNG, Dahej during December 2023.



Copepod



Copepod Nauplius



Crab larve



Gastropod larvae

Figure 4: Microphotographs of zooplanktons reported in the coastal waters of Petronet LNG, Dahej during December 2023

### 3.3 MACRO-BENTHIC FAUNA

The benthic zone is the lowest ecological zone of a water body which usually involves the sediments on the seafloor. The number of phyla and species of benthic animals exceeds those of pelagic species, at least partly because of the greater physical variety of benthic habitats. Benthic animals are separated into in faunal and epifaunal species, depending upon whether they live within sediments or on the surface of the seafloor, respectively. Size categories of the zoobenthos consist of the larger macrofauna (>1.0 mm), the small meiofauna which is characteristically found in sand and mud, and the microfauna which is made up mostly of protozoans.

Benthic organisms are morphologically different from those planktonic organisms. Many are adapted to live on the substrate (bottom). In benthic habitats, they can be considered dominant creatures. These organisms adapted to deep-water pressure so cannot survive in the upper parts of the water

column. Since light does not penetrate very deep ocean water, the benthic organisms often depend on the organic matter falling from the upper water column as their main energy source. This dead and decaying matter sustains the benthic food chain. The most benthic organisms are scavengers or detritivores. These organisms under being relatively stationary, are constantly exposed to changes undergoing in overlying water, and hence, respond very well to aquatic pollution. The macro benthos population is very sensitive to environmental perturbation and is highly influenced by the physicochemical characteristics of water, the nature of the substratum, food, predation, and other factors. The density of benthic invertebrates also fluctuates widely with the changes in the season.

- **Significance of macrobenthic organisms**

The biomass of microbenthic organisms in estuaries and coastal embayment is often high. Burrowing and tube-building by deposit-feeding benthic organisms (bioturbations) help to mix the sediment and enhance the decomposition of organic matter. Nitrification and denitrification are also enhanced because a range of oxygenated and anoxic micro-habitats are created. Macro fauna is also important constituents of fish diets and thus are an important link for transferring energy and nutrients between trophic levels, also driving pelagic fish and crustacean production. For these reasons, the benthic organisms are extremely important indicators of environmental change.

### 3.4 BENTHIC DIVERSITY

#### 3.4.1 Subtidal region:

During the present study, macrobenthos abundance and biomass were recorded at sub-tidal stations during high and low tide levels at Petronet LNG, Dahej (Table 6). The macrobenthos density ranged from 350 nos./m<sup>2</sup> to 480 nos./m<sup>2</sup> at sampling stations (Table 6; Figure 5) and comprising of 4 different groups (Mollusks, Sipuncula, Annelids and Foraminifera). The biomass of the macrobenthic community in the study region ranged from 1.54 g/m<sup>2</sup> to 1.97 g/m<sup>2</sup>. The maximum abundance of benthic microorganisms was reported at Station 1 (480 nos./m<sup>2</sup>) during high tide levels and mainly contributed by the dominance of polychaete worms. The highest biomass of macrobenthic species was observed at Station 1 (1.97 g/ m<sup>2</sup>) during high tide levels with the dominance of Polychaetas. The least density (350 no/m<sup>2</sup>) and biomass (1.48 g/m<sup>2</sup>) was observed at Station 2 during low tide level. In species composition, Annelida is the first largest group observed at all the stations during the present study where Polychaete species (Phylum Annelida) belonging to the family Paraonidae, Pilargidae, Capitillidae, Cossuridae, Spionidae, Nereidae, Eunicidae, were abundant. Secondly, bivalves & gastropods, foraminifera and sipunculids were present at all the sampled stations.

**Table 6: Faunal composition, density (nos./m<sup>2</sup>) and biomass (g/m<sup>2</sup>) of the macrobenthos community in the sub-tidal region at Petronet LNG, Dahej during December 2023.**

Benthos Faunal Groups	High tide Level				Low tide Level			
	St-1	St- 2	St- 3	St- 4	St- 1	St- 2	St- 3	St- 4
<b>Phylum Mollusca</b>								
Bivalves and gastropods	20	10	10	30	20	10	30	20
<b>Phylum Sipuncula</b>								
Sipunculids	20	20	20	10	10	30	30	10
Nemertine	30	40	20	0	10	30	20	20
<b>Phylum Annelida</b>								
Polychaetes	230	160	210	150	140	120	190	140
<b>Phylum Retaria</b>								
Foraminifera	180	160	160	180	190	160	190	180
<b>Density (nos./ m<sup>2</sup>)</b>	<b>480</b>	<b>390</b>	<b>420</b>	<b>370</b>	<b>370</b>	<b>350</b>	<b>460</b>	<b>370</b>
<b>Biomass (gm/m<sup>2</sup>)</b>	<b>1.97</b>	<b>1.68</b>	<b>1.74</b>	<b>1.54</b>	<b>1.55</b>	<b>1.48</b>	<b>1.75</b>	<b>1.54</b>

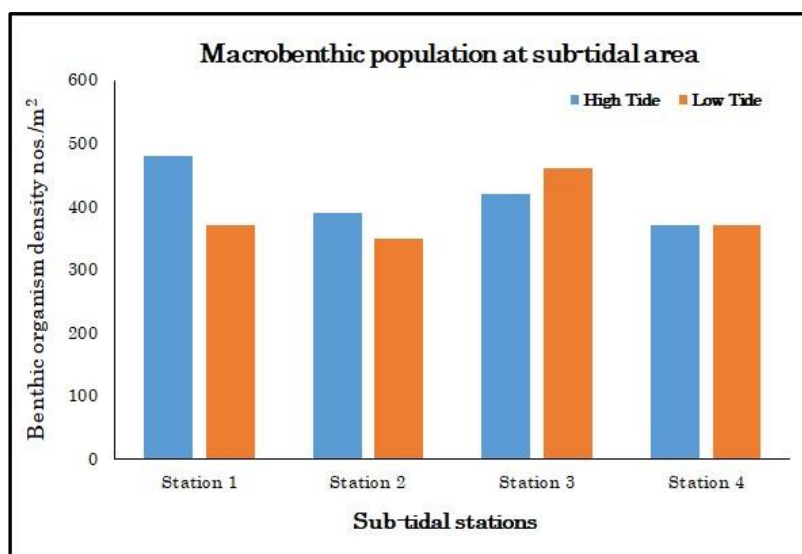

**Figure 5: Subtidal macrobenthos abundance (nos./m<sup>2</sup>) during high tide and low tide at different sampling stations at Petronet LNG, Dahej during December 2023.**

### 3.4.2 Intertidal region:

The muddy and sandy substratum with moderate organic matter supports the occurrence of the microbenthic community in the intertidal region. The macrobenthos biomass was measured in between 1.58 g/m<sup>2</sup> to 2.56 g/m<sup>2</sup> in the intertidal region at the Petronet LNG, Dahej (Table 7). The lowest density and biomass of macrobenthic organisms were reported at station IT-2 (322 nos./m<sup>2</sup> and

1.58 g/m<sup>2</sup>, respectively), whereas the highest density was reported at Station IT-3 (552 nos./m<sup>2</sup> and 2.56 g/m<sup>2</sup>, respectively) (Table 7 and Figure 6). In the inter-tidal area, Foraminifera (43.25%) and Polychaete (42.26%) species were contributed to the total macrobenthic abundance at these stations followed by bivalves and gastropods (4.81%). Some photographs of benthic fauna are shown in Figure 8.

**Table 7: Faunal composition, density (nos./m<sup>2</sup>) and biomass (g/m<sup>2</sup>) of the macrobenthos community in the inter-tidal region at Petronet LNG, Dahej during December 2023.**

Benthos Faunal Groups	Inter-tidal stations			
	IT-1	IT- 2	IT- 3	IT- 4
<b>Phylum Mollusca</b>				
Bivalves and gastropods	50	20	30	20
<b>Phylum Sipuncula</b>				
Sipunculids	10	20	10	0
Nemertine	20	10	10	20
<b>Phylum Annelida</b>				
Polychaetes	170	190	250	190
<b>Phylum Arthropoda</b>				
Decapod larvae (crab)	8	12	12	12
<b>Phylum Retaria</b>				
Foraminifera	190	170	240	190
<b>Density (nos./ m<sup>2</sup>)</b>	<b>448</b>	<b>422</b>	<b>552</b>	<b>432</b>
<b>Biomass (gm/m<sup>2</sup>)</b>	<b>1.64</b>	<b>1.58</b>	<b>2.56</b>	<b>1.65</b>

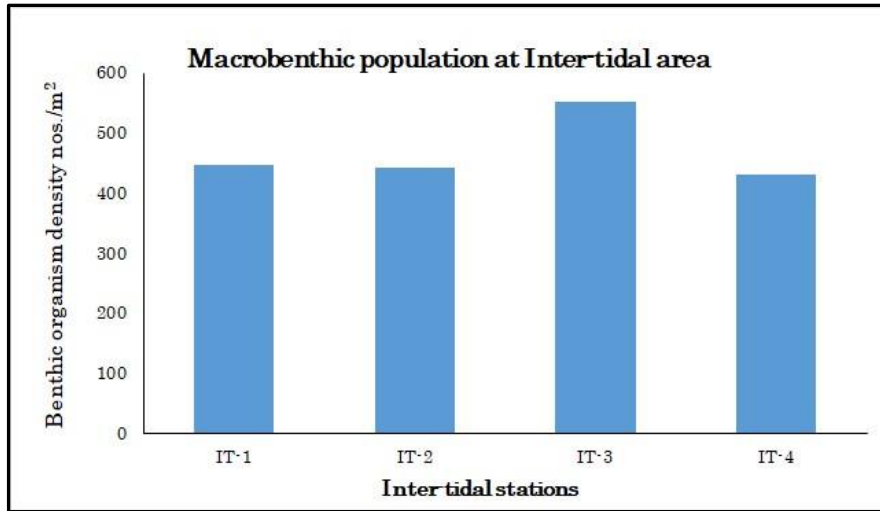

**Figure 6: Inter-tidal macro benthos abundance (nos./m<sup>2</sup>) at different sampling stations at Petronet LNG, Dahej during December 2023.**

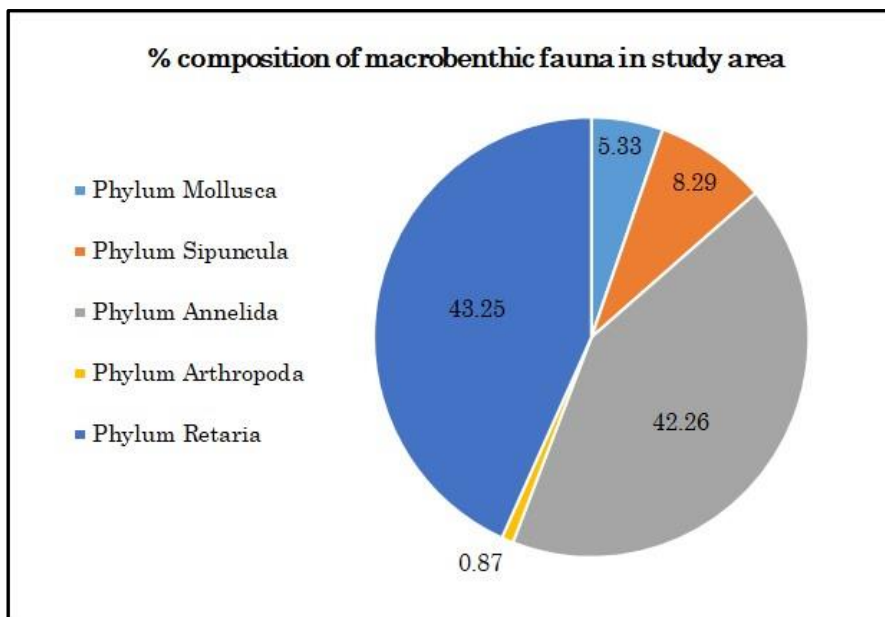

**Figure 7: Percent composition of Subtidal benthic taxa from the marine waters of Petronet LNG, Dahej during December 2023**



Capitallidae



Spoinidae



Pilargidae

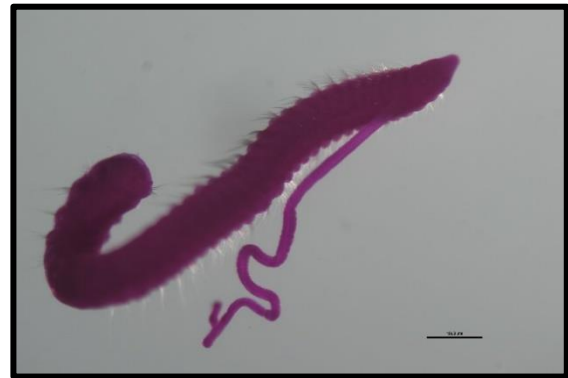

Cossuridae

Figure 8: Microphotographs of microbenthic organisms observed in the sediment samples collected in the vicinity of Petronet LNG, Dahej during December 2023

### 3.5 AVIFAUNAL DIVERSITY

Due to their importance in the ecosystem for various roles such as scavengers, pollinators for crops, seeds dispersal agents and also predators of insect pests, the avifaunal diversity study of a given region is a major indicator to evaluate habitats both qualitatively and quantitatively. Due to anthropogenic activities along with climate changes, the global diversity of birds is rapidly decreasing. IUCN Red List of endangered birds has already recognized 1226 bird species as threatened globally and whereas, 88 bird species are found in India.

Coastal and estuarine waters are always been important habitats for many bird species, including many migratory birds. Mudflats and sandy beaches are important feeding grounds for coastal birds and nearby mangrove forests and land trees provide shelter and breeding habitats. During the present study, an overview of the avifaunal diversity present in the study area has been taken. Due to the restricted approach to mudflats and shores directly for security reasons, only available bird species are listed in Table 8.



**Table 8: List of bird species observed in the study area.**

Sr. No.	Scientific name	Common name	IUCN category
1.	<i>Actitis hypoleucos</i>	Common sandpiper	Least concern (LC)
2.	<i>Ardeola grayii</i>	Indian pond Heron	Least concern (LC)
3.	<i>Bubulcus ibis</i>	Cattle egret	Least concern (LC)
4.	<i>Casmerodius albus</i>	Great egret	Least concern (LC)
5.	<i>Columba livia</i>	Rock dove	Least concern (LC)
6.	<i>Charadrius leschenaultii</i>	Sand plover	Least concern (LC)
7.	<i>Egretta gularis</i>	Western reef egret	Least concern (LC)
8.	<i>Larus heuglini</i>	Heuglin's gull	Least concern (LC)
9.	<i>Milvus migrans</i>	Black kite	Least concern (LC)
10.	<i>Vanellus indicus</i>	Red-wattled Lapwing	Least concern (LC)
11.	<i>Psittacula sp.</i>	Indian parakeet	Least concern (LC)
12.	<i>Aerodramus sp.</i>	Indian swiftlet	Least concern (LC)

Most of the bird species were observed foraging in the inter-tidal mud flats during low tide. Rock doves and Indian parakeets were observed to make nests in jetties and building structures. All the avifaunal species found in the study area are common in appearance and in the least concern (LC) category of the IUCN red list of threatened species.

### 3.6 MANGROVES

Mangroves are a very specialised group of plants found only in the transitional zone between land and the sea. The mangrove species are adapted to the salty water, less oxygen in sediments as well as daily tidal variation. The mangrove species developed a special kind of roots called 'Pneumatophores' which enables them for intake of air for plants in the water filled muddy soil. These breathing roots help mangrove trees to absorb oxygen from air and therefore thrive them into oxygen less muddy soil.

Mangrove plants generate a variety of natural resources and ecosystem services that are vital to subsistence economies and sustain local and national economies. During many natural calamities like cyclones, storm surges, heavy flooding and tsunamis they act as barriers and protect the land from erosion and reduce the effect on living resources. The value of mangroves as a carbon sink (absorb 4-5% more CO<sub>2</sub> than terrestrial trees) and the efficiency with which they can remove carbon from the atmosphere put them center stage in the context of increasing global concerns about climate change and sea level rise. They also maintain the stability of the shoreline and prevent the release of toxic

wastes into the coastal waters. The mangrove ecosystem is also a rich of nutrients in the coastal waters. The falling leaves from the mangrove area become the primary source of a food chain, which goes on to feed microorganisms, larvae and the adults of many invertebrates and fishes. These roots also harbor the number of fish species which use this area as their breeding grounds. It is estimated that over 70% of commercially important fishes depend on mangroves for their nutrient cycle and nursery breeding. This fish reach habitat attracts the number of birds and animals in the area thus making the mangroves a biodiversity reach habitat.

During the present study, scattered patches of mangroves mainly *Avicennia* species were found towards the northwest side of Petronet LNG jetties. All observed patches are shrub type and may be because of the high tidal amplitude in the Gulf of Khambhat and absence of adequate muddy habitat.

### 3.7 PHYTOPLANKTON DIVERSITY:

The phytoplankton are vast array of minute and microscopic plants passively drifting in natural waters and mostly confined to the illuminated zone. In an ecosystem these organisms constitute primary producers forming the first link in the food chain. The phytoplankton have long been used as indicators of water quality. Some species flourish in highly eutrophic waters, while others are very sensitive to organic and/or chemical wastes. Because of their short life cycles, plankton responds quickly to environmental changes. Hence, their standing crop in terms of biomass, cell counts and species composition are more likely to indicate the quality of the water mass in which they are found. Phytoplankton composition also varies considerably. Thus, a very few species may be overwhelmingly common during blooms, while a large number of species may occur without clear dominance under normal conditions.

Phytoplankton sampling was carried out at 4 stations from three levels i.e., Surface, Middle and Bottom at HTL (High Tide Level), LTL (Low Tide Level) and IT (Intertidal zone). During the sampling period (December 2023) the phytoplankton population in the coastal waters of Petronet LNG, Dahej was diverse and represented with a total of 34 phytoplankton genera (Table 9) belonging to diatoms (29 genera) and dinoflagellates (5 genera). Diatoms Species belonged to *Amphora* sp., *Amphorprora* sp., *Asterionella* sp., *Bacillaria* sp., *Chaetoceros* sp., *Corethron* sp., *Coscinodiscus* sp., *Cyclotella* sp., *Cylindrotheca* sp., *Cymbella* sp., *Diploneis* sp., *Ditylum* sp., *Guinardia* sp., *Gyrosigma* sp., *Lauderia* sp., *Leptocylindrus* sp., *Licmophora* sp., *Lithodesmium* sp., *Navicula* sp., *Nitzschia* sp., *Odontella* sp., *Paralia* sp., *Pinnularia* sp., *Pleurosigma* sp., *Pseudo-nitzschia* sp., *Rhizosolenia* sp., *Synedra* sp., *Thalassiosira* sp. and *Thalassionema* sp.

The phytoplankton abundance in the study region was ranged from 108 to 239 cells $\times 10^2/L$  (Table 9, Figure 9) at HTL. The highest phytoplankton abundance was observed at Station 4 in the surface (239 nos. $\times 10^2/L$ ) and lowest at Station 2 in bottom water (108 nos. $\times 10^2/L$ ). The phytoplankton abundance was ranged from 91 to 207 nos. $\times 10^2/L$  (Table 9, Figure 9) at LTL. The highest phytoplankton abundance at LTL was (207 nos. $\times 10^2/L$ ) was observed at Station 4 in surface water and lowest was at station 2 bottom water (91 nos. $\times 10^2 / L$ ). The phytoplankton abundance was ranged from 123 to 143 nos. $\times 10^2/L$  (Table 9, Figure 9) at Intertidal zone. The highest phytoplankton abundance at IT was (143 nos. $\times 10^2/L$ ) was observed at Station 1 and lowest was at station 2 (123 nos. $\times 10^2 / L$ ). The study shows that the marine water around was enriched with the diverse phytoplankton population.

**Table 9: Phytoplankton abundance (cells×10<sup>2</sup>/L) at different sampling stations during High Tide Level (HTL) in the coastal waters of Petronet LNG, Dahej during December 2023.**

Note: S=surface; M= Middle; B=bottom; HTL= High Tide Level; St=station

Phytoplankton Genera	Sampling Stations (HTL)											
	St-1			St-2			St-3			St-4		
	S	M	B	B	M	B	S	M	B	S	M	B
<b>Diatoms</b>												
<i>Amphora</i> sp.	0	1	0	3	8	1	1	0	7	4	7	4
<i>Amphorprora</i> sp.	0	0	0	0	1	2	23	1	0	1	0	1
<i>Asterionella</i> sp.	35	20	15	31	18	3	19	3	1	35	40	35
<i>Bacillaria</i> sp.	2	1	0	4	10	6	2	0	4	9	4	4
<i>Chaetoceros</i> sp.	3	3	5	1	3	1	2	0	2	3	4	3
<i>Corethron</i> sp.	0	0	0	0	2	0	0	0	0	2	0	1
<i>Coscinodiscus</i> sp.	40	34	15	18	15	19	20	10	10	15	10	12
<i>Cyclotella</i> sp.	0	2	2	0	0	6	0	0	1	5	0	1
<i>Cylindrotheca</i> sp.	1	0	2	0	5	1	1	5	1	2	0	2
<i>Cymbella</i> sp.	0	1	0	1	0	0	0	0	1	0	1	0
<i>Diploneis</i> sp.	1	0	0	0	1	2	0	0	0	4	1	4
<i>Ditylum</i> sp.	6	6	1	1	1	1	11	6	1	1	1	1
<i>Guinardia</i> sp.	14	6	11	20	0	3	3	10	8	0	16	0
<i>Gyrosigma</i> sp.	2	0	2	1	2	0	3	2	0	3	0	0
<i>Lauderia</i> sp.	1	0	0	1	0	2	4	0	0	2	0	0
<i>Leptocylindrus</i> sp.	3	1	5	5	0	2	0	1	2	5	0	3
<i>Licmophora</i> sp.	0	5	2	0	0	1	1	2	3	1	3	0
<i>Lithodesmium</i> sp.	5	0	0	1	2	0	3	8	4	1	5	8
<i>Navicula</i> spp.	11	11	1	2	5	4	5	10	8	12	11	5
<i>Nitzschia</i> spp.	5	10	10	12	10	5	9	10	5	34	20	35
<i>Odontella</i> sp.	15	10	1	1	9	4	15	12	10	33	30	20
<i>Paralia</i> sp.	0	0	0	12	12	15	11	6	2	2	2	2
<i>Pinnularia</i> sp.	10	0	2	2	0	0	10	0	2	3	2	2
<i>Pleurosigma</i> spp	0	12	0	2	8	2	14	12	8	6	12	2
<i>Pseudo-nitzschia</i> sp.	2	0	2	1	0	1	4	4	2	0	0	0
<i>Rhizosolenia</i> sp.	2	1	8	11	3	3	1	8	3	13	3	5
<i>Synedra</i> sp.	0	0	0	0	1	1	2	0	2	3	2	1
<i>Thalassionema</i> sp.	15	10	8	5	8	14	14	15	11	25	5	10
<i>Thalassiosira</i> sp.	2	5	12	10	2	0	3	0	15	6	0	1
<b>Dinoflagellates</b>												
<i>Alexandrium</i> sp.	1	1	0	1	1	2	1	1	1	2	1	2
<i>Ceratium</i> sp.	4	2	1	3	1	2	2	1	0	3	3	2
<i>Gymnodinium</i> sp.	0	0	0	1	2	3	0	2	4	2	2	3
<i>Prorocentrum</i> sp.	2	1	3	1	2	2	2	1	1	1	1	1
<i>Protoperidinium</i> sp.	2	1	3	0	2	0	1	0	1	1	1	0
<b>Total Phytoplankton (nos. x 10<sup>2</sup>/L)</b>	<b>184</b>	<b>144</b>	<b>111</b>	<b>151</b>	<b>134</b>	<b>108</b>	<b>187</b>	<b>130</b>	<b>120</b>	<b>239</b>	<b>187</b>	<b>170</b>

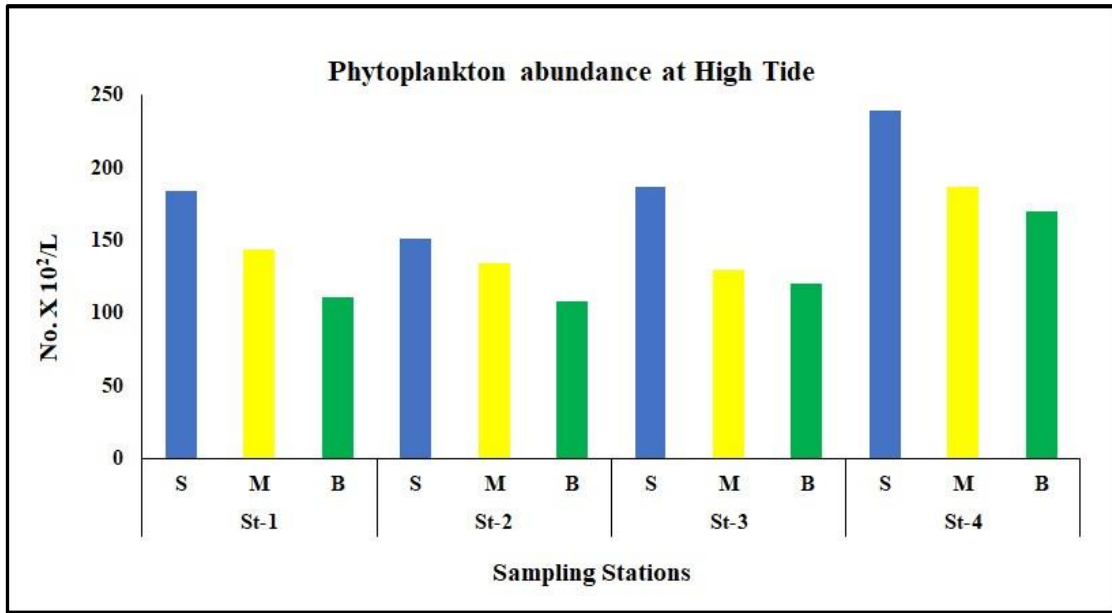

**Figure 9: High Tidal Level (HTL) phytoplankton abundance (no. x10<sup>2</sup>/ L) at different sampling stations at Petronet LNG, Dahej during December 2023**

**Table 10: Phytoplankton abundance (cells×10<sup>2</sup>/L) at different sampling stations during Low Tide Level (LTL) in the coastal waters of Petronet LNG, Dahej during December 2023.**

Note: S=surface; M= Middle; B=bottom; LTL= Low Tide Level; St=station

Phytoplankton Genera	Sampling Stations (LTL)											
	St-1			St-2			St-3			St-4		
	S	M	B	B	M	B	S	M	B	S	M	B
<b>Diatoms</b>												
<i>Amphora</i> sp.	1	0	0	3	7	1	1	0	7	10	11	1
<i>Amphorprora</i> sp.	1	0	0	0	1	2	4	1	0	1	0	1
<i>Asterionella</i> sp.	18	18	21	13	18	3	11	3	12	41	30	10
<i>Bacillaria</i> sp.	2	1	0	4	10	2	2	0	4	9	4	4
<i>Chaetoceros</i> sp.	1	1	1	2	2	0	1	0	1	5	5	0
<i>Corethron</i> sp.	1	0	0	0	2	0	0	0	0	1	0	1
<i>Coscinodiscus</i> sp.	21	23	18	20	16	8	15	15	0	15	2	1
<i>Cyclotella</i> sp.	1	2	2	0	0	4	3	0	1	7	2	1
<i>Cylindrotheca</i> sp.	1	0	1	1	3	1	4	4	0	2	0	2
<i>Cymbella</i> sp.	1	1	0	1	1	0	2	0	0	0	2	0
<i>Diploneis</i> sp.	0	1	0	0	1	0	1	2	0	4	0	1
<i>Ditylum</i> sp.	5	5	1	0	0	1	9	6	1	1	1	1
<i>Guinardia</i> sp.	8	5	12	19	0	3	3	10	8	5	8	0
<i>Gyrosigma</i> sp.	2	1	1	0	2	1	1	0	2	0	2	2
<i>Lauderia</i> sp.	0	2	0	0	1	0	0	4	0	4	0	0
<i>Leptocylindrus</i> sp.	5	0	0	3	0	2	1	1	0	5	0	3
<i>Licmophora</i> sp.	0	3	2	0	0	1	0	2	3	1	3	0
<i>Lithodesmium</i> sp.	5	1	0	1	2	0	3	6	5	1	4	1
<i>Navicula</i> spp.	19	1	0	1	5	4	5	11	12	12	11	5
<i>Nitzschia</i> spp.	4	16	10	17	4	7	4	8	5	23	21	21
<i>Odontella</i> sp.	10	9	1	1	5	4	13	8	10	12	10	13
<i>Paralia</i> sp.	9	0	0	10	13	20	16	10	2	2	2	2
<i>Pinnularia</i> sp.	8	0	5	2	0	0	11	0	2	3	2	2
<i>Pleurosigma</i> spp	2	10	0	2	7	2	9	10	4	7	12	2
<i>Pseudo-nitzschia</i> sp.	1	1	1	2	1	3	4	4	1	0	0	0
<i>Rhizosolenia</i> sp.	1	1	11	12	3	3	3	8	3	13	3	2
<i>Synedra</i> sp.	2	0	1	0	0	1	2	0	1	3	2	1
<i>Thalassionema</i> sp.	11	10	5	1	9	10	7	9	5	11	5	10
<i>Thalassiosira</i> sp.	10	1	15	11	2	0	3	0	8	1	0	1
<b>Dinoflagellates</b>												
<i>Alexandrium</i> sp.	2	1	1	1	2	1	1	1	1	3	1	1
<i>Ceratium</i> sp.	3	2	1	2	1	1	4	2	0	1	2	0
<i>Gymnodinium</i> sp.	1	2	0	1	2	2	0	3	2	2	2	2
<i>Prorocentrum</i> sp.	0	0	1	1	0	3	1	0	0	1	1	1
<i>Proto-peridinium</i> sp.	2	1	1	0	1	1	0	0	1	1	1	0
<b>Total Phytoplankton (nos. x 10<sup>2</sup>/L)</b>	<b>158</b>	<b>119</b>	<b>112</b>	<b>131</b>	<b>121</b>	<b>91</b>	<b>144</b>	<b>128</b>	<b>101</b>	<b>207</b>	<b>149</b>	<b>92</b>

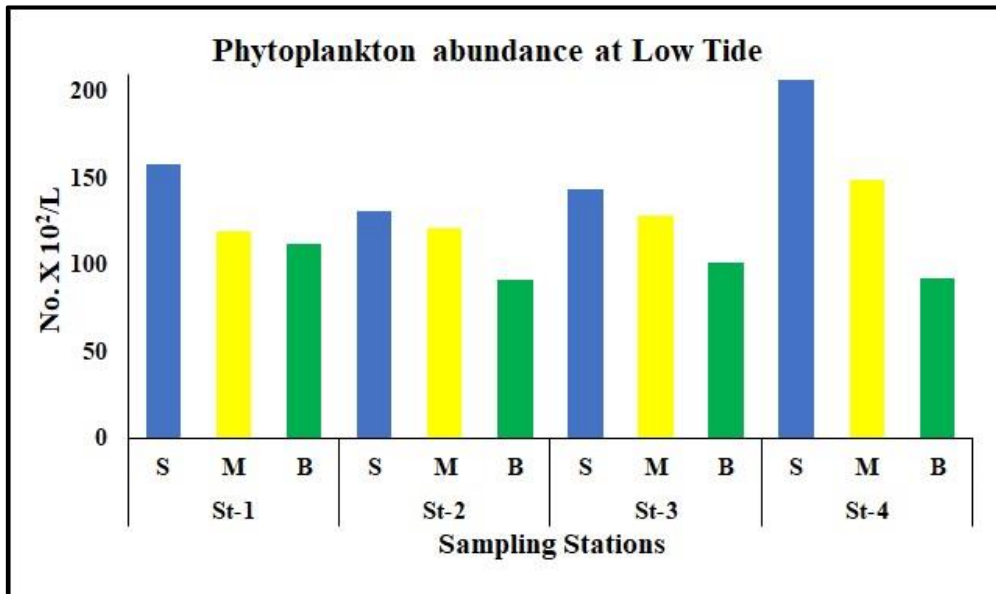

Figure 10: Low Tidal Level (LTL) phytoplankton abundance (no. x10<sup>2</sup>/ L) at different sampling stations at Petronet LNG, Dahej during December 2023

**Table 11: Phytoplankton abundance (cells×10<sup>2</sup>/L) at different sampling stations during Intertidal zone of Petronet LNG, Dahej during December 2023.**

Phytoplankton Genera	Sampling stations			
	IT1	IT2	IT3	IT4
<b>Diatoms</b>				
<i>Amphora</i> sp.	1	0	1	3
<i>Amphorprora</i> sp.	1	0	0	0
<i>Asterionella</i> sp.	12	15	19	12
<i>Bacillaria</i> sp.	2	1	0	4
<i>Chaetoceros</i> sp.	0	1	4	2
<i>Corethron</i> sp.	0	0	0	0
<i>Coscinodiscus</i> sp.	20	23	25	21
<i>Cyclotella</i> sp.	1	2	2	0
<i>Cylindrotheca</i> sp.	1	0	0	6
<i>Cymbella</i> sp.	1	1	1	1
<i>Diploneis</i> sp.	0	1	0	0
<i>Ditylum</i> sp.	5	5	1	1
<i>Guinardia</i> sp.	8	5	10	11
<i>Gyrosigma</i> sp.	2	2	3	0
<i>Lauderia</i> sp.	0	2	1	0
<i>Leptocylindrus</i> sp.	4	0	0	3
<i>Licmophora</i> sp.	0	3	2	0
<i>Lithodesmium</i> sp.	0	0	2	1
<i>Navicula</i> spp.	20	15	0	1
<i>Nitzschia</i> spp.	4	11	10	15
<i>Odontella</i> sp.	11	8	4	1
<i>Paralia</i> sp.	1	0	4	10
<i>Pinnularia</i> sp.	10	0	0	2
<i>Pleurosigma</i> spp	2	10	0	2
<i>Pseudo-nitzschia</i> sp.	5	0	1	1
<i>Rhizosolenia</i> sp.	1	1	16	11
<i>Synedra</i> sp.	1	0	0	0
<i>Thalassionema</i> sp.	20	10	10	1
<i>Thalassiosira</i> sp.	1	1	15	20
<b>Dinoflagellates</b>				
<i>Alexandrium</i> sp.	1	0	1	0
<i>Ceratium</i> sp.	4	3	3	2
<i>Gymnodinium</i> sp.	1	2	0	1
<i>Prorocentrum</i> sp.	1	0	0	3
<i>Protoperidinium</i> sp.	2	1	1	0
<b>Total Phytoplankton (nos. x 10<sup>2</sup>/L)</b>	<b>143</b>	<b>123</b>	<b>136</b>	<b>135</b>



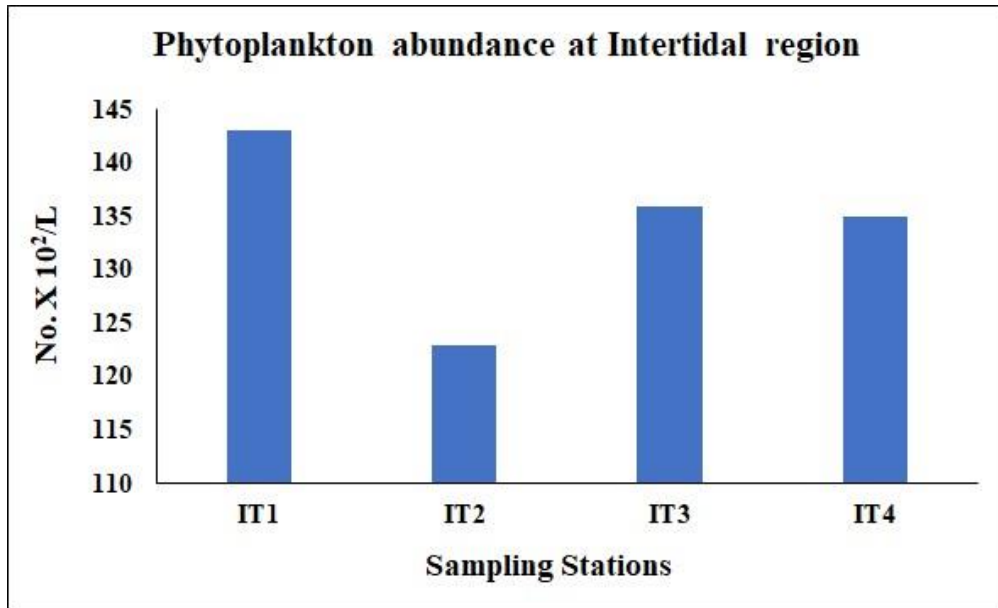
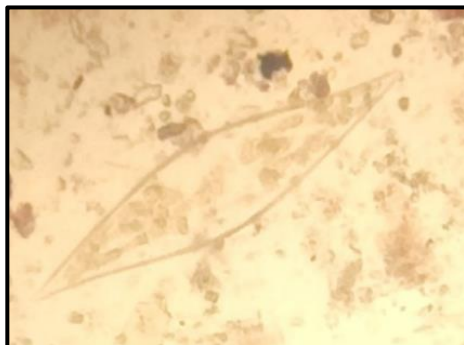

Figure 11: Inter-tidal phytoplankton abundance (no. x10<sup>2</sup>/ L) at different sampling stations at Petronet LNG, Dahej during December 2023.



*Navicula sp.*



*Odontella sp.*



*Coscinodiscus sp.*



*Ceratium sp.*

Fig. 12- Microphotographs of phytoplankton reported in the coastal waters of Petronet LNG, Dahej during December 2023.

### 3.8 PHYTOPLANKTON PIGMENTS (CHLOROPHYLL *a* AND PHEOPHYTIN):

Marine phytoplankton contains essential as well as accessory pigments like that of terrestrial plants. Phytoplankton pigments capture sunlight. The resulting photosynthesis and its products, especially the oxygen and organic compounds, all rely on the light energy captured by the different phytoplankton pigments. Chlorophyll *a* is the major pigment for light harvesting, and plays a significant role in photosynthesis and photoprotection, by extending the light collection window and protecting the cell from the damage of high irradiance levels or high ultraviolet light exposure.

Algal chlorophyll forms a series of degradation products upon degradation. In addition to Chlorophyll the naturally occurring pigments in algal cells. The nature of these degradation products depends on which part of the chlorophyll molecule is affected. As chlorophyll degrades, the initial step is either the loss of the magnesium from the center of the molecule or the loss of the phytol tail. This results in the formation of the molecule, phaeophytin. Depending on the parent molecule several distinct molecules like phaeophytins, chlorophyllides, and pheophorbides can be produced. Thus, in addition to Chlorophyll *a* filtered seawater contains color degradation products of phytoplankton pigments.

### 3.9 CHLOROPHYLL *a* AND PHAEOPHYTIN CONCENTRATIONS

The phytoplankton biomass distribution expressed in terms of Chlorophyll *a* (Chl-*a*) and Pheophytin at selected stations in the coastal region of Petronet LNG, Dahej during December 2023. The samples for chlorophyll *a* and pheophytin is analysed for High Tide Level (HTL), Low tide level (LTL) and Inter-tidal zone (IT). For HTL and LTL samples collected from surface, middle and bottom and for IT samples collected only form surface water. The Chl-*a* concentrations in the HTL surface water were ranged from 1.29 mg/m<sup>3</sup> to 2.10 mg/m<sup>3</sup>. The Pheophytin content was ranged from 0.20 mg/m<sup>3</sup> to 0.34 mg/m<sup>3</sup>. The Chl-*a* concentrations in the HTL middle water were ranged from 1.18 mg/m<sup>3</sup> to 1.78 mg/m<sup>3</sup>. The Pheophytin content was ranged from 0.16 mg/m<sup>3</sup> to 0.32 mg/m<sup>3</sup>. The Chl-*a* concentrations in the HTL bottom water were ranged from 1.10 mg/m<sup>3</sup> to 1.33 mg/m<sup>3</sup>. The Pheophytin content was ranged from 0.10 mg/m<sup>3</sup> to 0.32 mg/m<sup>3</sup>. The Chl-*a* concentrations in the IT water were ranged from 1.22 mg/m<sup>3</sup> to 1.32 mg/m<sup>3</sup>. The Pheophytin content was ranged from 0.22 mg/m<sup>3</sup> to 0.35 mg/m<sup>3</sup>.

The Chl-*a* concentrations in the LTL surface water were ranged from 1.18 mg/m<sup>3</sup> to 1.57 mg/m<sup>3</sup>. The Pheophytin content was ranged from 0.22 mg/m<sup>3</sup> to 0.40 mg/m<sup>3</sup>. The Chl-*a* concentrations in the LTL middle water were ranged from 1.06 mg/m<sup>3</sup> to 1.62 mg/m<sup>3</sup>. The Pheophytin content was ranged from 0.12 mg/m<sup>3</sup> to 0.33 mg/m<sup>3</sup>. The Chl-*a* concentrations in the LTL bottom water were ranged from 0.90 mg/m<sup>3</sup> to 1.23 mg/m<sup>3</sup>. The Pheophytin content was ranged from 0.10 mg/m<sup>3</sup> to 0.34 mg/m<sup>3</sup>.

**Table 12: Chlorophyll *a*, Pheophytin concentrations in the surface marine water of Petronet LNG, Dahej at High Tide level (HTL) and Inert-tidal zone (IT) during December 2023.**

Sr. No.	Parameters	Unit	High Tide Level (HTL)							
			Surface Water							
			St.1	St.2	St.3	St.4	IT1	IT2	IT3	IT4
1.	Chlorophyll <i>a</i>	mg/m <sup>3</sup>	1.44	2.10	1.29	1.49	1.32	1.25	1.22	1.28
2	Pheophytin	mg/m <sup>3</sup>	0.34	0.42	0.20	0.25	0.35	0.22	0.30	0.30

**Table 13: Chlorophyll *a*, Pheophytin concentrations in the middle marine water of Petronet LNG, Dahej at High Tide level (HTL) during December 2023.**

Sr. No.	Parameters	Unit	High Tide Level (HTL)							
			Middle Water							
			St.1	St.2	St.3	St.4	IT1	IT2	IT3	IT4
1.	Chlorophyll <i>a</i>	mg/m <sup>3</sup>	1.20	1.26	1.18	1.78	-	-	-	-
2	Pheophytin	mg/m <sup>3</sup>	0.16	0.31	0.29	0.32	-	-	-	-

**Table 14: Chlorophyll *a*, Pheophytin concentrations in the bottom marine water of Petronet LNG, Dahej at High Tide level (HTL) during December 2023.**

Sr. No.	Parameters	Unit	High Tide Level (HTL)							
			Bottom Water							
			St.1	St.2	St.3	St.4	IT1	IT2	IT3	IT4
1.	Chlorophyll <i>a</i>	mg/m <sup>3</sup>	1.10	1.21	1.12	1.33	-	-	-	-
2	Phaeophytin	mg/m <sup>3</sup>	0.10	0.23	0.28	0.32	-	-	-	-

**Table 15: Chlorophyll *a*, Pheophytin concentrations in the surface marine water of Petronet LNG, Dahej at Low Tide level (LTL) and Inert-tidal zone (IT) during December 2023.**

Sr. No.	Parameters	Unit	Low Tide Level (LTL)			
			Surface Water			
			St.1	St.2	St.3	St.4
1.	Chlorophyll <i>a</i>	mg/m <sup>3</sup>	1.30	1.57	1.18	1.40
2	Pheophytin	mg/m <sup>3</sup>	0.32	0.38	0.40	0.22

**Table 16: Chlorophyll *a*, Pheophytin concentrations in the middle marine water of Petronet LNG, Dahej at Low Tide level (LTL) during December 2023.**

Sr. No.	Parameters	Unit	Low Tide Level (LTL)			
			Middle Water			
			St.1	St.2	St.3	St.4
1.	<b>Chlorophyll <i>a</i></b>	mg/m <sup>3</sup>	1.10	1.18	1.06	1.62
2	<b>Pheophytin</b>	mg/m <sup>3</sup>	0.12	0.32	0.32	0.33

**Table 17: Chlorophyll *a*, Pheophytin concentrations in the bottom marine water of Petronet LNG, Dahej at Low Tide level (LTL) during December 2023.**

Sr. No.	Parameters	Unit	Low Tide Level (LTL)			
			Bottom Water			
			St.1	St.2	St.3	St.4
1.	<b>Chlorophyll <i>a</i></b>	mg/m <sup>3</sup>	0.90	1.10	1.01	1.23
2	<b>Pheophytin</b>	mg/m <sup>3</sup>	0.10	0.25	0.34	0.25

### 3.9 SEA GRASS AND MACRO ALAGE (SEA WEEDS)

During the present study, no occurrence of sea grasses and sea weeds in the inter-tidal area was observed.

## 4.0 CONCLUSION

### 4.1 Chemical Analysis of Water Sample

- pH at all Subtidal region Sampling Station was observe between rang in 7.82 to 8.06.
- Temperature at all Subtidal region Sampling Station was observed around 28° to 28.3° C
- Turbidity at all Subtidal region Sampling Station was observed between 5 to 10 NTU
- Total Suspended Solids at all Subtidal region Sampling Station was observed between 196 to 255 mg/L
- Biochemical Oxygen Demand (BOD) Solids at all Subtidal region Sampling Station was observed between 3.1 to 3.9 mg/L
- Oil & Grease and Ammonical Nitrogen at all Subtidal region Sampling Station was observed under below detection limit.
- Salinity at all Subtidal region Sampling Station was observed between 24.05 to 30.26 ppt
- Dissolved Oxygen at all Subtidal region Sampling Station was observed between 6.1 to 6.6 mg/L

- Total Alkalinity as CaCO<sub>3</sub> at all Subtidal region Sampling Station was observed between 125.6 to 150.8 mg/L
- Phosphate at all Subtidal region Sampling Station was observed between 0.14 to 0.50 mg/L
- Nitrate at all Subtidal region Sampling Station was observed under below detection limit.
- Calcium Carbonate at all Subtidal region Sampling Station was observed between 720 to 814.3 mg/L
- Petroleum Hydrocarbon (PHc) at all Subtidal region Sampling Station was Not detected.
- In microbiological parameter Total Coliform at all Subtidal region Sampling Station was observed between Absent to 66 CFU/100ml

#### 4.2 Biological parameters of water samples

- The Chl-*a* and Pheophytin concentrations were more in the surface water as compared to the bottom water. The variations observed between the surface and bottom waters could be due to several natural biological variability.
- During the sampling period (December-2023) the phytoplankton population in the coastal waters of Petronet LNG, Dahej was diverse and represented with a total of 34 phytoplankton genera (Table 9) belonging to diatoms (29 genera) and dinoflagellates (5 genera).
- In the sub-tidal area, more density and species were reported in the surface water than middle and bottom waters. This difference could be attributed to the depth of water as surface water are more productive due to more penetration of light which decreases as increase in depth of water.
- The occurrence of copepods and their nauplii together with decapods and fish larvae/eggs in zooplankton samples highlights the fair production potential of live food resources (organisms) to support the fish and crustacean population in the study region.
- Difference in zooplankton abundance during high tide level and low tide level in the sub-tidal area was observed during the present study. Increased levels of suspended solids and the apparent increase in turbidity of water as well as high current during low tide will be considered as a possible reason for low zooplankton abundance during low tide levels.
- Compared to sub-tidal stations, in inter-tidal region zooplankton abundance was observed to be less and higher turbidity and current caused by the lower depth of water in inter-tidal areas also possible reasons for the same.
- During present study, two groups of organisms i.e. Foraminifera contributed to the 43% and Polychaete worms contributed to the 42% of total benthic organisms. Overall, the presence of Polychaete and Sipuncula worms suggests the availability of food organisms for benthic predators in the area. Due to presence of sand in the study area, foraminiferans are more abundant.

- Mangrove species *Avicennia* sp. is very sparse.
- Avifauna present in the study area is most common type.
- Overall, considering biological parameters of the study area, the study area is showed healthy environment contributing good production of phytoplankton, zooplankton and benthic organisms.

- Different Types of Sampling Photographs



\*\*\*\*\*

## ANNEXURE - II - ENVIROMENT DATA

### AMBIENT AIR QUALITY STATUS REPORT

All units are in  $\mu\text{g}/\text{m}^3$ .

Sr.no.	Month	PM10		PM2.5		SOx		NOx		HC as Methane CH <sub>4</sub>	
		Min	Max	Min	Max	Min	Max	Min	Max	Min	Max
	NAAQ norms	100 $\mu\text{g}/\text{m}^3$		60 $\mu\text{g}/\text{m}^3$		80 $\mu\text{g}/\text{m}^3$		80 $\mu\text{g}/\text{m}^3$		Absent	
1	Apr-24	55.00	67.00	20.00	27.00	13.20	19.60	16.70	24.60	BDL	BDL
2	May-24	52.00	68.00	18.00	26.00	12.30	19.40	15.60	24.30	BDL	BDL
3	Jun-24	52.00	67.00	19.00	26.00	12.30	20.20	16.20	25.70	BDL	BDL
4	Jul-24	55.00	67.00	18.00	28.00	12.20	19.60	17.30	26.30	BDL	BDL
5	Aug-24	46.00	55.00	17.00	24.00	12.70	19.10	16.60	26.50	BDL	BDL
6	Sep-24	47.00	55.00	16.00	24.00	12.60	19.10	16.40	25.70	BDL	BDL
7	Oct-24										
8	Nov-24										
9	Dec-24										
10	Jan-25										
11	Feb-25										
12	Mar-25										
	Range (April-24 to Sept 24)	46-68		16-28		12.3-20.2		16.2-26.5		BDL	



## STACK EMISSION AIR QUALITY STATUS REPORT

Sr.no.	Month	GTG		
		SPM	SO <sub>x</sub>	NO <sub>x</sub>
GPCB norms		150 mg/NM <sup>3</sup>	100 ppm	50 ppm
1	Apr-24	BDL	BDL	16.40
2	May-24	BDL	BDL	16.50
3	Jun-24	BDL	BDL	18.40
4	Jul-24	BDL	BDL	17.60
5	Aug-24	BDL	BDL	18.40
6	Sep-24			
7	Oct-24			
8	Nov-24			
9	Dec-24			
10	Jan-25			
11	Feb-25			
12	Mar-25			
	Range (April-24 to Sept 24)	BDL	BDL	16.4-18.4

**BDL: Below Detection Level.**







**MARINE WATER QUALITY STATUS REPORT**

Sr.no.	Parameter	Unit	Jun-24	Sep-24	Dec-24	Mar-25
			MW	MW	MW	MW
1	Temperature	*C	31.5	31		
2	PH	-	7.72	8.29		
3	Color	Co-pt	70	70		
4	Total Suspended Solids	mg/L	84	80		
5	Total Dissolved Solids (TDS)	mg/L	>10000	>10000		
6	Chlorides as CL	mg/L	>5000	>5000		
7	Sulphate as SO4	mg/L	>2000	>2000		
8	BOD (5 days @ 20°C)	mg/L	38	32		
9	COD	mg/L	161.2	111.2		
10	Oil & Grease	mg/L	BDL	BDL		
11	Phenolic Compound	mg/L	BDL	BDL		
12	Zinc as Zn	mg/L	0.167	0.152		
13	Total Chromium as Cr+3	mg/L	0.082	0.066		
14	Lead as Pb	mg/L	BDL	BDL		
15	Cyanide as CN	mg/L	BDL	BDL		
16	Flouride as F	mg/L	0.91	0.82		
17	Copper as Cu	mg/L	0.067	0.054		
18	Insecticide	mg/L	Absent	Absent		
19	Pesticide	mg/L	BDL	BDL		
20	Mercury as Hg	mg/L	BDL	BDL		
21	Hexavalent Chromium as Cr+6	mg/L	BDL	BDL		
22	Nickel as Ni	mg/L	BDL	BDL		
<b>ND*: Not detected</b>						

# Traffic Impact Study Report

**Petronet LNG Limited (PLL)**

April 2022

## Abbreviations

PLL	Petronet LNG Limited
CRIS	CRISIL Risk and Infrastructure Solutions Limited
AADT	Annual Average Daily Traffic
ADT	Average Daily Traffic
HSD	High Speed Diesel
LCV	Light Commercial Vehicle
LNG	Liquefied Natural Gas
LOS	Level of Service
MoSRTTH	Ministry of Road Transport & Highways
NMT	Non-motorized Traffic
NSDP	Net State Domestic Product
O-D	Origin-Destination
PCI	Per Capita Income
PCU	Passenger Car Unit
RLNG	Regasified LNG
RSI	Road-Side Interview
SVF	Seasonal Variation Factor
TVC	Traffic Volume Control

# Contents

<b>1</b>	<b>Introduction</b> .....	<b>7</b>
1.1	About Petronet LNG Limited and Third Jetty Project at Dahej LNG Terminal.....	8
<b>2</b>	<b>Traffic Surveys Planning and Schedule</b> .....	<b>9</b>
2.1	Traffic surveys and collection of data.....	9
2.2	Schedule of Traffic Surveys.....	10
2.3	Methodology of Traffic Surveys.....	10
<b>3</b>	<b>Mid-Block Traffic Volume Analysis</b> .....	<b>11</b>
3.1	Passenger Car Unit (PCU).....	11
3.2	Classified Traffic Volume Count.....	11
3.3	Average Daily Traffic (ADT).....	12
3.4	Seasonal variation factor.....	13
3.5	Annual Average Daily Traffic (AADT).....	14
3.6	AADT Modal Split and Traffic characteristics.....	15
3.7	Peak Hour Factor.....	16
<b>4</b>	<b>Origin-destination Survey and Analysis</b> .....	<b>18</b>
4.1	Roadside Interview Method.....	18
4.2	Zonal Code.....	19
4.3	O-D Analysis.....	20
4.4	Trip frequency distribution.....	21
4.5	Commodity Distribution.....	22
4.6	Pay Load distribution.....	24
4.7	Distribution of trips by Trip purpose.....	24
4.8	Vehicle Occupancy.....	24
4.9	State wise vehicle Contribution.....	25
<b>5</b>	<b>Parking Survey</b> .....	<b>26</b>
<b>6</b>	<b>Turning Movement Survey and Junction Improvement</b> .....	<b>27</b>
<b>7</b>	<b>Traffic Forecast</b> .....	<b>30</b>
7.1	Secondary Data Collection.....	30
7.2	Transport demand elasticity – Econometric models.....	31
7.3	Elasticity of Transport Demand Values - Road Development Plan, Vision 2021.....	32
<b>8</b>	<b>Traffic Projections and Road Capacity</b> .....	<b>34</b>
<b>9</b>	<b>Road Inventory and Condition Survey</b> .....	<b>36</b>



**10 Conclusion .....37**

# List of Tables

Table 1: Traffic Surveys – Schedule.....	10
Table 2: Passenger Car Unit (PCU) .....	11
Table 3: Average Daily Traffic (ADT).....	12
Table 4: Seasonal variation for Fuel consumption .....	14
Table 5: Seasonal Variation Factors for AADT.....	14
Table 6: Annual Average Daily Traffic (AADT) .....	15
Table 7: Peak hour factor .....	16
Table 8: % O – D Sample size.....	18
Table 9: Zonal code for O-D analysis .....	19
Table 10: Zonal Trip distribution .....	20
Table 11: Trip Frequency distribution .....	21
Table 12: Percentage (%) of commodity distribution.....	22
Table 13: Average Pay load in Tonnes .....	24
Table 14: Trip Purpose .....	24
Table 15: Average Occupancy .....	25
Table 16: State wise vehicle contribution .....	25
Table 17: Pedestrian flows along the road .....	26
Table 18: Junction improvement.....	28
Table 19: Vehicle registration and economic indicators .....	30
Table 20: Elasticity Analysis .....	32
Table 21: Elasticity Values.....	32
Table 22: Projected Traffic growth rates.....	33
Table 23: Projected V/C Ratio and Level of Service .....	34

**List of Figures**

Figure 1: Location Map of Project Road ..... 7

Figure 2: Traffic Surveys in Progress ..... 9

Figure 3: Average Hourly Variation of Traffic volume ..... 13

Figure 4: AADT vehicle composition ..... 16

Figure 5: Trip Frequency Distribution ..... 22

Figure 6: Commodity Distribution for Commercial Vehicles ..... 23

Figure 7: Parking Accumulation Curve ..... 26

Figure 8: Dahej Amod chowk junction ..... 27

Figure 9: GACL Chokdi junction ..... 28

Figure 10: Total Traffic and Capacity Projection ..... 34

# 1 Introduction

Roads form the spine of any emerging economy – India is no exception. The economic benefits of a newly constructed/ improved road, both in terms of direct and indirect benefits, are immense. An accurate estimate of the traffic that is likely to use the Project Road is very important as it forms the basic input in planning, design, and operation. A thorough knowledge of the travel characteristics of the traffic using the Project Road as well as other major roads in the influence area of the study corridor is essential for future traffic estimation. The road under consideration is SH – 206 of 5 Km length connecting many industrial zones in Lakhigam with rest of the areas in Baruch district in the state of Gujarat. The improvement of this road leads to the improvement in the economic activity of the influencing zone. The location map (marked in red color) of the project road under consideration are shown in Figure 1.

**Figure 1: Location Map of Project Road**

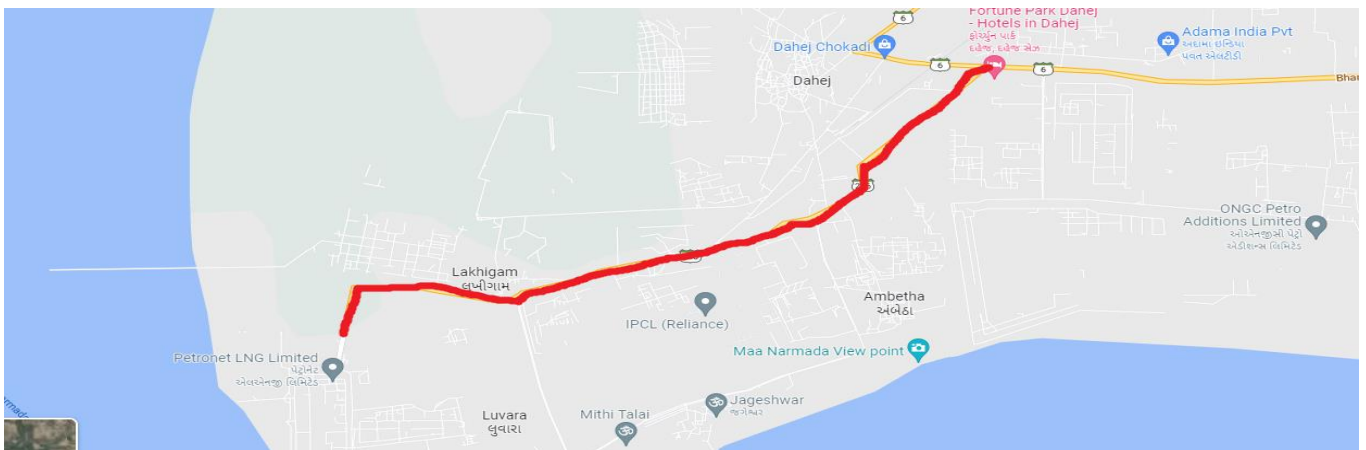

The objective of the traffic survey and analysis of the observed data is:

- Determination of Average Daily Traffic (ADT)
- Determination of Annual Average Daily Traffic (AADT)
- Identification of zone of influence for the project stretch
- Extent of influence based on O-D survey
- Design of parking facilities
- Determination of traffic growth rates; and
- Capacity and Level of Service (LOS) analysis

## 1.1 About Petronet LNG Limited and Third Jetty Project at Dahej LNG Terminal

Petronet LNG Limited is one of the fastest growing world-class Public Limited Company in the Indian energy sector. It has set up the country's first LNG receiving and regasification terminal at Dahej, Gujarat with present nominal capacity of 17.5 MMTPA and another terminal at Kochi, Kerala having a nominal capacity of 5 MMTPA.

The capacity of the Dahej LNG terminal has been expanded in phases which is currently 17.5 MMTPA. The terminal has 6 LNG storage tanks and other vaporization facilities. The terminal is meeting around 40% of the total gas demand of the country. The terminal has two LNG Jetties at Dahej.

Third jetty project at Dahej LNG Terminal involves construction of approx. 2.49 km long Jetty for unloading of LNG and transport to the onshore storage tanks through unloading lines. Third jetty will also have provision to unload liquid ethane and propane in future.

During operation phase, LNG would be converted to natural gas through onshore regasification facilities and regasified LNG (RLNG) would be transported to customers through dedicated underground pipelines and no surface movement is envisaged.

During construction phase, there will be increase in road traffic (approx. 25 no. per day) for transportation of construction material and personal. However, these activities will be limited for short period.

## 2 Traffic Surveys Planning and Schedule

### 2.1 Traffic surveys and collection of data

Traffic forms a key element of project preparation studies of road projects. It has a direct bearing on several aspects, including carriageway configuration and width requirements, pavement thickness, structural design, other design features and elements, wayside facilities as well as revenues and project viability, both economic and financial. An extensive analysis of the traffic database developed by conducting various surveys has been made not only to appreciate present traffic and travel characteristics but also to arrive at realistic traffic scenarios for future years on the project road. In order to assess the traffic volume and modal split, the Consultants have carried out Classified Traffic Volume Count (TVC) surveys at Reliance industries Limited (Lakhigam) along the project road. To capture the traffic and travel characteristics of predominant category of vehicles, 1 day Origin-Destination and commodity movement surveys by Road side Interview (RSI) method were conducted along the project road at the same location. Photographs showing the TVC and RSI surveys in progress are presented in Figure 2.

Figure 2: Traffic Surveys in Progress



## 2.2 Schedule of Traffic Surveys

A detailed schedule of TVC and OD surveys conducted along the project road are listed and presented in Table – 1.

**Table 1: Traffic Surveys – Schedule**

S. No.	Type of Survey	Location	Date of Survey	Duration of Survey
1	Classified Traffic Volume Count survey	Reliance Industries Limited (Lakhigam)	23.02.22 to 01.03.22	7 Days
2	Origin-Destination Survey	Reliance Industries Limited (Lakhigam)	24.02.22	1 Day

## 2.3 Methodology of Traffic Surveys

- Video graphic recording and counting system was adopted at each location under the supervision of qualified Traffic Engineers, to eliminate data collection errors and managed by a supervisor.
- Continuous 24-hour traffic volume count survey was conducted using video graphic recording in both directions. At office, enumerators specially trained for this purpose, recorded the number of vehicles of different categories moving along the road in both directions by viewing the CVC videos and summary sheets were prepared. The vehicles are broadly classified into motorized passenger vehicles, motorized goods vehicles, and non-motorized vehicles. These groupings have further been sub-divided to reflect the present-day traffic pattern more realistically.
- The video Cameras recording the direction wise traffic were positioned at location, where there was clear visibility of the flow of vehicles in respective direction.
- 1-day O-D survey was conducted on normal working day by Road-Side Interview (RSI) method for 24 continuous hours in 3 shifts on random sample basis. A sample of well above 20% was targeted, to obtain a fair representative data.
- Banners indicating “Traffic Volume Count in progress” with name of Consultants is displayed near the survey stations (written in blue on white cloth), so that this is visible at least 200m ahead on both sides. Since, round the clock surveys were carried out, arrangements for lighting and temporary shelters were made to conduct surveys during night.

### 3 Mid-Block Traffic Volume Analysis

The data collected from primary and secondary sources are recorded in Excel sheets, compiled, checked, and corrected before further proceeding for analysis. Traffic data analysis has been carried out, to understand traffic characteristics and travel pattern in the study area and to provide basic input for traffic capacity assessment.

#### 3.1 Passenger Car Unit (PCU)

The traffic flow is measured in terms of number of vehicles per unit time. Since Indian traffic is heterogeneous in nature, it is common practice to convert the traffic in terms of Passenger car units (PCUs). The traffic data (in vehicles) collected during field surveys have been compiled and converted into equivalent Passenger Car Units (PCU) to determine the Average Daily Traffic (ADT) in vehicles and in PCU. Table - 2 lists the adopted PCU equivalent for different vehicle type based on IRC: 64-1990.

**Table 2: Passenger Car Unit (PCU)**

Vehicle Type	PCU factor
Two Wheelers	0.5
Three Wheelers	1.0
Car/Jeep/Van/Taxi/Ambulance	1.0
Mini Bus	1.5
Bus (Gov/ Pvt)	3.0
Goods (3W /4W)	1.0
LCV	1.5
2 Axle Truck	3.0
3 Axle Truck	3.0
M Axle Truck	4.5
HCM /EME	4.5
Cycle	0.5
Cycle Rikshaw	2.0
Animal and hand drawn	6.0
Agricultural Tractor	1.5
Agricultural Tractor with trailer	4.5

#### 3.2 Classified Traffic Volume Count

The analysis has been carried out to derive:

- Average Daily Traffic (ADT) for fast- and slow-moving vehicles
- Average Daily Variation and average Hourly Variation
- Annual Average Daily Traffic (AADT) after seasonal correction
- Traffic composition pattern for passenger, goods, and non-motorized vehicles



- Peak hour traffic variation for passenger and commercial vehicles

## 3.3 Average Daily Traffic (ADT)

The classified traffic volume count data collected is analyzed to assess the traffic intensity along the project road. Table – 3 presents the summary of Average Daily Traffic along the project road with salient findings. Detailed calculations are presented in **Annexure – 1**. The day wise hourly variation of total traffic presented in Figure 3, reveals that there is not much variation in passenger and commercial traffic intensity over the day and reduced traffic levels have been observed during night hours for all vehicles.

**Table 3: Average Daily Traffic (ADT)**

Vehicle Type	To GACL	To Lakhigam	Total Traffic
2-Wheeler	924	949	1873
Auto	201	201	402
Car /Jeep/Van/Tempo	1376	1338	2714
Mini. Bus	24	28	52
Pvt. Bus	204	196	400
Govt. Bus	2	1	3
3-Wheeler Tempo	9	9	18
4-Wheeler Tempo	341	336	677
LCV	120	109	229
2-Axle	20	19	39
3-Axle	174	156	330
M Axle	791	777	1568
M Axle > 6 Axle	0	0	0
HCM/EME	16	13	29
Agri. Tractor	5	5	10
Agri. Tractor & Trailor	28	30	58
Animal & Hand Drawn	2	2	4
Cycle	30	31	61
Cycle Rickshaw	1	0	1
Others	2	4	6
Cars/ Jeep/ Van (Toll Exempted Vehicles)	0	1	1
Ambulance (Toll Exempted Vehicles)	0	0	0

Bus/Truck (Toll Exempted Vehicles)	0	0	0
<b>Tollable Traffic (Vehicles)</b>	<b>3068</b>	<b>2973</b>	<b>6041</b>
<b>Tollable Traffic (PCU)</b>	<b>6765</b>	<b>6552</b>	<b>13317</b>
<b>Total Traffic (Vehicles)</b>	<b>4270</b>	<b>4205</b>	<b>8475</b>
<b>Total Traffic (PCU)</b>	<b>7602</b>	<b>7413</b>	<b>15015</b>

Figure 3: Average Hourly Variation of Traffic volume

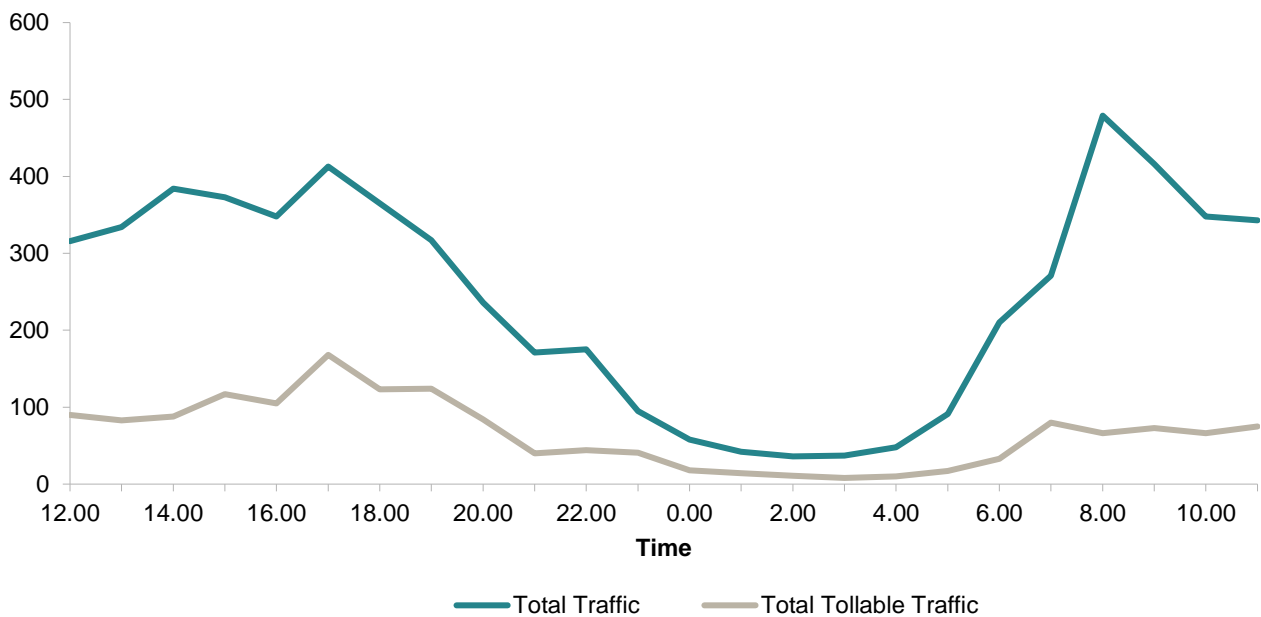

### 3.4 Seasonal variation factor

Traffic fluctuates by the hour, by the day and by the month. Hence, it is essential to estimate a factor which provides a relationship between Annual Average Daily Traffic (AADT) and Average Daily Traffic (ADT) for the month corresponding to the traffic surveys. While hourly and daily fluctuations have been accounted for by conducting surveys for continuous 168 hours (7 days), the Seasonal Variation Factor (SVF) will be required to estimate AADT from the ADT data. The seasonal variation factor is estimated using the past fuel sales data collected from the existing petrol bunks along the project road. As the length of the project road is only 5 Km and no fuel stations are observed along the project road, the fuel sales data has been collected from the fuel stations on SH-6 which leads traffic to the project road. The petrol (MS) and diesel (HSD) sales data in liters consumption has been collected for the past two years and analyzed for the monthly variation in the sales of fuel as per IRC: 108-2015. Table – 4 presents the analysis to assess the seasonal variation factor and detailed calculations are given in **Annexure – 2**.

**Table 4: Seasonal variation for Fuel consumption**

Month of the year	Indian oil petrol pump on SH-6 (Gujarat)				Reliance Petroleum on SH-6 (Gujarat)			
	2020		2021		2020		2021	
	MS (kl)	Diesel (kl)	MS (kl)	Diesel (kl)	MS (kl)	Diesel (kl)	MS (kl)	Diesel (kl)
January	26	45	26	28	20	180	13	145
February	26	92	26	40	20	180	20	150
March	24	54	26	46	25	205	25	155
April	24	25	28	32	20	50	25	50
May	29	49	30	30	24	45	20	63
June	28	86	18	12	25	88	28	95
July	24	48	28	28	20	150	30	100
August	28	56	30	36	24	155	20	88
September	26	28	26	46	28	150	25	85
October	30	36	26	16	20	145	20	70
November	28	32	22	8	20	150	30	63
December	26	34	28	34	25	150	30	63
<b>Average seasonal index</b>	<b>98.46</b>	<b>91.12</b>	<b>95.15</b>	<b>94.18</b>	<b>96.10</b>	<b>83.21</b>	<b>97.28</b>	<b>89.29</b>

The traffic surveys are conducted in the month of February 2022. From the analyzed fuel sales data, the seasonal variation factors are taken as shown in Table – 5, for AADT calculations.

**Table 5: Seasonal Variation Factors for AADT**

S. No.	TVC Location	Petrol vehicles	Diesel vehicles
1	Reliance Industries Limited	1.03	0.94

### 3.5 Annual Average Daily Traffic (AADT)

The Annual Average Daily Traffic for the project road is obtained by multiplying the Average Daily Traffic (ADT) with the seasonal correction factor. The AADT of the project road for the year 2021-22 is presented in Table – 6.

**Table 6: Annual Average Daily Traffic (AADT)**

Vehicle Type	To GACL	To Lakhigam	Total Traffic
2-Wheeler	952	977	1929
Auto	189	189	378
Car /Jeep/Van/Tempo	1355	1318	2673
Mini. Bus	23	26	49
Pvt. Bus	192	184	376
Govt. Bus	2	1	3
3-Wheeler Tempo	8	8	17
4-Wheeler Tempo	321	316	636
LCV	113	102	215
2-Axle	19	18	37
3-Axle	164	147	310
M Axle	744	730	1474
M Axle > 6 Axle	0	0	0
HCM/EME	15	12	27
Agri. Tractor	5	5	9
Agri. Tractor & Tractor	26	28	55
Animal & Hand Drawn	2	2	4
Cycle	30	31	61
Cycle Rickshaw	1	0	1
Others	2	4	6
Cars/ Jeep/ Van (Toll Exempted Vehicles)	0	1	1
Ambulance (Toll Exempted Vehicles)	0	0	0
Bus/Truck (Toll Exempted Vehicles)	0	0	0
<b>Tollable Traffic (Vehicles)</b>	<b>2946</b>	<b>2855</b>	<b>5801</b>
<b>Tollable Traffic (PCU)</b>	<b>6421</b>	<b>6218</b>	<b>12638</b>
<b>Total Traffic (Vehicles)</b>	<b>4161</b>	<b>4101</b>	<b>8262</b>
<b>Total Traffic (PCU)</b>	<b>7250</b>	<b>7070</b>	<b>14321</b>

### 3.6 AADT Modal Split and Traffic characteristics

- 2-Wheeler and car traffic is about 23% and 32% respectively in the total traffic along the road at this location as shown in Figure 4.

# Infrastructure Advisory

- The share of non-motorized vehicles is almost nil.
- The commercial vehicles contribute 35% as a first major share in the total traffic as there are many industrial establishments along the project road.
- The contribution of buses is 5% in total vehicles using the corridor.
- The share of 3 Wheelers is almost 4% acting as local passenger transport vehicles.
- The PCU ratio along the road is 1:1.77 signifying the contribution of commercial vehicles in total traffic.
- Tollable traffic constitute 71% in the total traffic using this road.

**Figure 4: AADT vehicle composition**

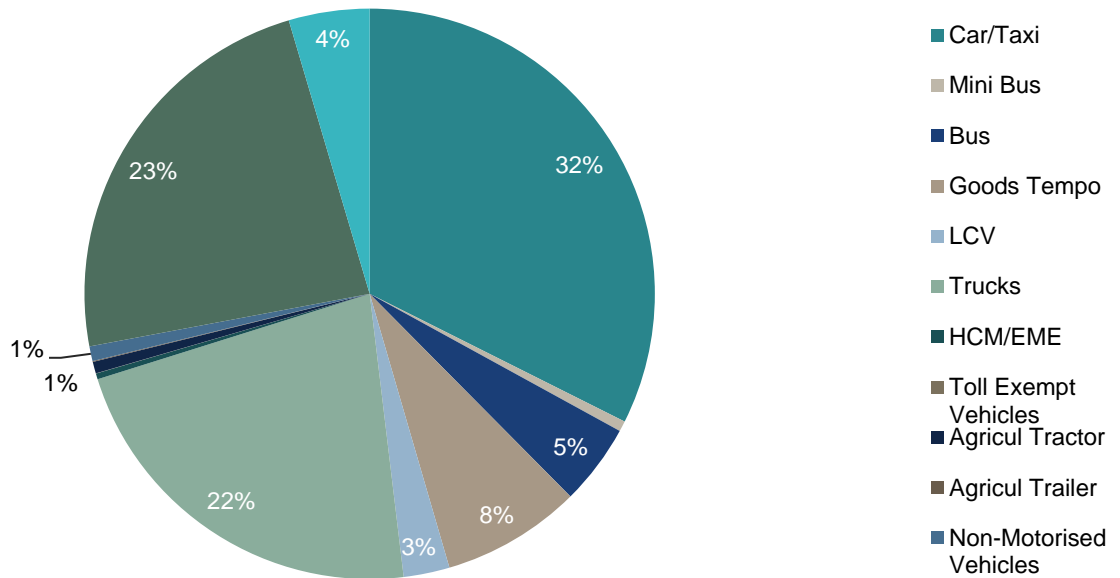

## 3.7 Peak Hour Factor

The peak hour factor is defined as the traffic volume during peak hour expressed as a percentage of AADT. The day (04:00 AM to 16:00 PM) and night time (16:00 PM to 04:00 AM) peak factors are calculated at the traffic count location as given in Table – 7 indicate fairly uniform distribution of the traffic volume during the day time and night peak hour factors indicates slightly higher traffic volumes during the peak hour at night time.

**Table 7: Peak hour factor**

S. No.	TVC Location	Peak Hour	Peak hour volume (Veh)	Peak hour volume (PCU)	AADT (Veh)	Peak Hour Factor (%)

1	Reliance Industries Limited	17.00 to 18.00	690	1160	8262	8.35
---	-----------------------------	-------------------	-----	------	------	------

## 4 Origin-destination Survey and Analysis

The origin and destination of trips on the existing road is needed to estimate the information regarding travel characteristics of different users on the project road. The origin – destination data is also needed for identifying the major influence zones along the road, as traffic growth on the project road is directly dependent upon the growth in economic activity of the influencing area. These surveys are important in defining the traffic movement and travel desire patterns in the transport network along the study corridor and to derive the traffic growth rates based on the information of trip ends and travel characteristics of the road users of different types. The location of origin and destination zones is determined in relation to survey station and possibility of traffic diversion to the project road from/to other routes. Appropriate location is selected to conduct interviews without affecting movement of other vehicles.

### 4.1 Roadside Interview Method

The vehicles are stopped on random sample basis with the help of a traffic police. Designated trained enumerators have interviewed the traffic and entered the data in the well-designed format. A volume count survey was carried out simultaneously to get the number of vehicles passing in both the directions in order to assess the sample size. This survey is limited to Standard Bus and Car in passenger vehicles category, LCV and Trucks (2 Axle / 3 Axle / M Axle) in freight vehicle category. The following pertinent information of travel has been collected during the interview from the commuters. The sample size for goods and passenger vehicles in percentage is presented in Table – 8.

- Origin and destination of trip
- Type of vehicle
- Trip purpose and occupancy
- Commodity type and Tonnage
- Trip Frequency and vehicle registration number

**Table 8: % O – D Sample size**

Vehicle Type	To Lakhigam	To GACL
Car	25	25
Bus	33	44
Mini Bus	41	34
Mini LCV	34	33
LCV	38	39
2 Axle	37	50
3 Axle	43	36
M Axle	39	42

## 4.2 Zonal Code

Traffic movement on a particular stretch depends on its zone of influence. The zones of influence can be external and/or internal. The zones within Baruch district are considered as internal zones and the zones outside are considered as external zones. Appropriate zoning system is adopted, and coding is done for zones, type of vehicle and its origin and destination. The zonal distribution adopted for analysis is given in Table - 9. Zones from 1 to 9 are considered as internal zones for trip interaction analysis.

**Table 9: Zonal code for O-D analysis**

Zone No	Zonal description	District	State
1	Petronet LNG Limited	Baruch	Gujarat
2	Dahej, Ambeta, Lakhigam, Luvara	Baruch	Gujarat
3	Baruch, Vilayat, Manubar, Pakhajan, Trankal, Muler, Jolva, Harinagar, Padariya	Baruch	Gujarat
4	Derol, Dayadara, Vajara, Pahaj, Chanchvel, Machasara, Nahiyer, Amod	Baruch	Gujarat
5	Trasla, Samni, Tankanj, Paler, Matar, Vasna	Baruch	Gujarat
6	Jambusar, Gajera, Sarod, Sigam, Bhadkodara, Devla	Baruch	Gujarat
7	Chavaj, Kabirwd, Bhalod, Panetha, Ankleshwar, Zagadia	Baruch	Gujarat
8	Valia, Dharoli, Gandiya, Zarnavadi, Netrang, Rajpardi	Baruch	Gujarat
9	Hansot, Diva, Panoli, Panjroli, Motvan, Ujai	Baruch	Gujarat
10	Vadodara	Districts	Gujarat
11	Panchmahal, Mahisagar	Districts	Gujarat
12	Dahod	Districts	Gujarat
13	Narmada, Chota Udaipur	Districts	Gujarat
14	Surat, Tapi, Dang	Districts	Gujarat
15	Navsari, Valsad	Districts	Gujarat
16	Anand, Kheda, Gandhinagar, Ahmedabad	Districts	Gujarat
17	Aravali, Sabarkantha	Districts	Gujarat
18	Banaskantha, Mehsana, Patan	Districts	Gujarat
19	Surendranagar, Morbi	Districts	Gujarat
20	Botad, Bhavnagar, Amreli, Gir somnath	Districts	Gujarat
21	Rajkot, Junagadh, Porbandar, Jam nagar, Dwaraka	Districts	Gujarat
22	Bhuj	Districts	Gujarat
23	Rajasthan		States



24	Delhi, Haryana		States
25	Punjab, Himachal Pradesh		States
26	Jammu and Kashmir, Ladakh		States
27	Uttar Pradesh, Uttarakhand		States
28	Madhya Pradesh		States
29	Maharashtra, Daman and Deu		States
30	Bihar, Jharkhand, West Bengal		States
31	Chattisgarh, Odisha		States
32	Andhra Pradesh, Telangana		States
33	Karnataka, Goa		States
34	Tamilnadu, Kerala		States
35	North East states		States

## 4.3 O-D Analysis

The O-D analysis findings are shown in Table 10. The O – D trip end matrices have been prepared and mode wise distribution of trips between internal and external zones has been derived on origin destination pairs as furnished in **Annexure – 3**.

**Table 10: Zonal Trip distribution**

Vehicle Type	I-I	I-E	E-I	E-E
Car	96%	2%	2%	0%
Bus	99%	1%	1%	0%
Mini Bus	100%	0%	0%	0%
Car pooling	91%	0%	9%	0%
Mini LCV	72%	20%	8%	0%
LCV	57%	29%	14%	0%
2 Axle	55%	23%	22%	0%
3 Axle	45%	36%	19%	0%
M Axle	96%	2%	2%	0%

*Note: I-I: Internal to Internal, I-E: Internal to External, E-I: External to Internal, E-E: External to External*

These findings are based on the trips intercepted on the project road during the traffic surveys. From the generated trip end matrices, 98% of the passenger trips are distributed within project influenced district i.e., within Baruch district particularly among the zone numbers 1, 2 and 3. 65% of the commercial trips are distributed within project influenced district i.e., within Baruch district. Around 20% of the commercial trips are either external to internal or vice versa as many industrial establishments are situated along the project road.

## 4.4 Trip frequency distribution

The O-D data collected has been analyzed to study the trip frequency distribution over the project road. Following are the salient findings from O-D information collected from the survey. The mode-wise average trip frequency distribution is presented in Table - 11 and in Figure 5.

- Nearly 60% of the passenger vehicles are using the project road on daily basis.
- Nearly 35% of the commercial vehicles are using the project road on monthly basis.
- 87% of buses are using the project corridor on daily basis.
- 25% of freight vehicles are making trips for weekly once.
- 45% of commercial vehicles are making trips on daily basis.

**Table 11: Trip Frequency distribution**

Vehicle Type	Daily	Weekly	Monthly	Occasionally / Yearly
Car	33%	63%	4%	1%
Bus	87%	11%	2%	0%
Mini Bus	57%	26%	17%	0%
Mini LCV	67%	24%	9%	0%
LCV	47%	25%	28%	0%
2 Axle Truck	38%	24%	38%	0%
3 Axle Truck	36%	28%	36%	0%
M Axle Truck	33%	20%	47%	0%

**Figure 5: Trip Frequency Distribution**

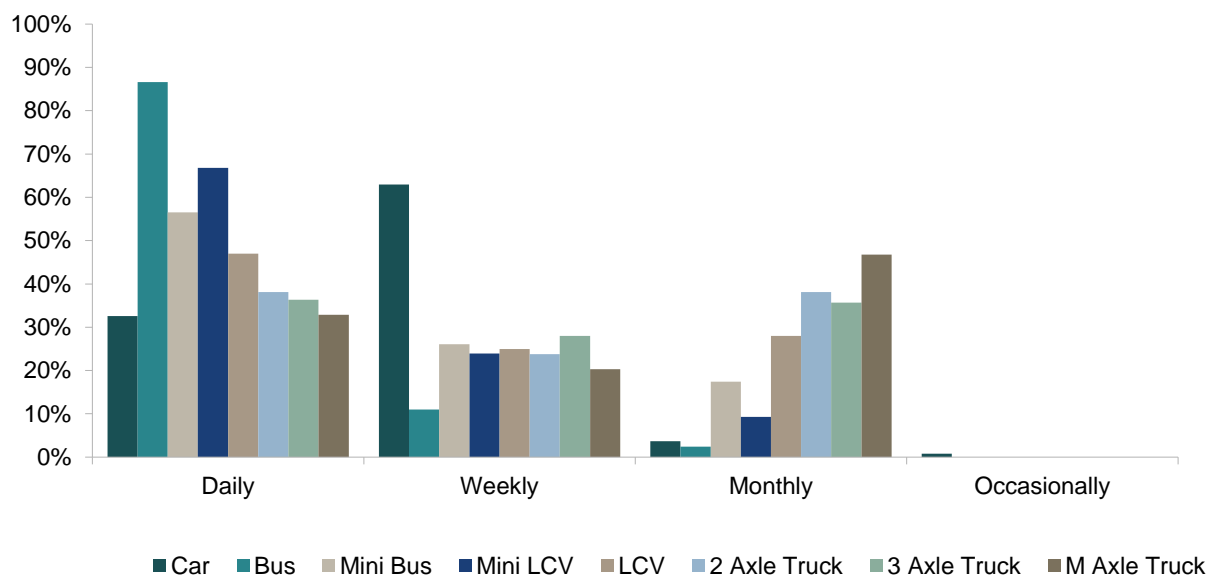

## 4.5 Commodity Distribution

The O-D data collected has been analyzed to study the type of commodities carried by the commercial vehicles along the project road. The percentage of each type of commodity carried by each mode of commercial vehicle is presented in Table – 12 and in Figure 6. From the analysis, it can be concluded that, LCVs are transporting all types of coal, minerals, and petroleum products. Commodities like coal, minerals and petroleum products and building materials are primarily transported by Trucks. Around 40% of the empty vehicles are reported during survey as empty vehicles are transporting towards Lakhigam.

**Table 12: Percentage (%) of commodity distribution**

Code	Commodity Type	Mini LCV	LCV	2 Axle	3 Axle	M Axle
1	Food grains and pulses	2%	0%	0%	1%	0%
2	Cash crops	0%	0%	0%	0%	0%
3	Vegetables and Fruits	2%	1%	0%	0%	0%
4	Processed Food Items	0%	0%	0%	0%	0%
5	Packed food items	0%	0%	0%	0%	0%

6	Fishery, Poultry and Animal feed, Passengers	0%	0%	0%	0%	0%
7	Building Materials	8%	5%	14%	10%	7%
8	Industrial Raw Materials	0%	0%	0%	0%	0%
9	Consumer Goods	1%	3%	0%	1%	1%
10	Fertilizers, Chemicals and Pharmaceuticals	5%	0%	5%	16%	12%
11	Machinery and Automobiles	0%	0%	0%	0%	0%
12	Coal, minerals, and petroleum Products	23%	36%	48%	32%	44%
13	Parcel Goods and containers	0%	0%	0%	0%	0%
14	Empty	58%	55%	33%	40%	34%
15	Industrial Outputs	1%	0%	0%	1%	1%
16	Liquor and Cool Drinks	0%	0%	0%	0%	0%

**Figure 6: Commodity Distribution for Commercial Vehicles**

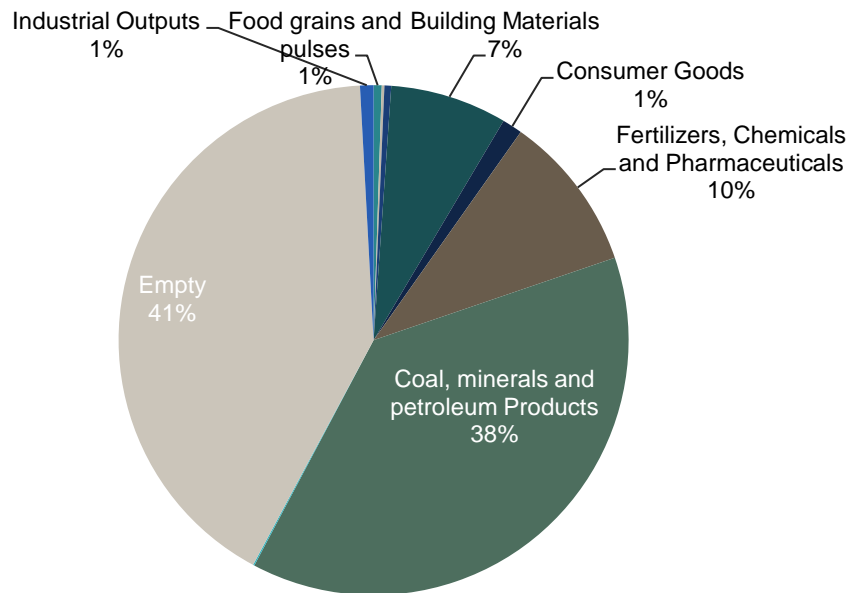

## 4.6 Pay Load distribution

The pay load and load distribution analysis has been done as it influences the vehicle damage factor in the pavement design, based on the RSI survey data and the findings are presented in Table – 13. It is observed that, trucks are carrying an average load of 15 Tonnes and LCVs are carrying in the range of 3.5 Tonnes.

**Table 13: Average Pay load in Tonnes**

Vehicle Type	0 – 3	3 – 5	5 – 10	10 – 15	15 – 20	20 – 30	30 - 40	> 40	% Empty
Mini LCV	42%	0%	0%	0%	0%	0%	0%	0%	58%
LCV	17%	8%	20%	0%	0%	0%	0%	0%	55%
2 Axle	38%	5%	5%	19%	0%	0%	0%	0%	33%
3 Axle	6%	7%	13%	8%	17%	9%	0%	0%	40%
M Axle	1%	1%	3%	5%	26%	15%	15%	1%	34%

## 4.7 Distribution of trips by Trip purpose

From the Table – 14, it can be inferred that approximately 60% of the trips are work based followed by business and social trips.

**Table 14: Trip Purpose**

Vehicle Type	Work	Education	Business	Social	Shopping	Recreation	Health	Religious	Others
Car	70%	3%	6%	10%	1%	1%	4%	2%	2%
Mini Bus	48%	0%	52%	0%	0%	0%	0%	0%	0%

## 4.8 Vehicle Occupancy

Average occupancy and occupancy range of passenger vehicles is given in Table - 15. It is observed that, the average occupancy of car is 3 to 4 passengers, the average occupancy of carpooling is 5 and that of bus is 35 in normal occupancy ranges.

**Table 15: Average Occupancy**

Vehicle Type	0 – 2	2 – 5	5 – 8	8 – 20	20 – 50	> 50
Car	54%	42%	4%	0%	0%	0%
Bus	0%	0%	0%	14%	86%	0%
Mini Bus	0%	0%	0%	100%	0%	0%

## 4.9 State wise vehicle Contribution

The results obtained from the registered number plate information were used to identify the project influence area. The ratio of the total traffic originated/destined to a particular zone to the total traffic gives the influence factor for the particular zone. The influence zone information has been obtained from the analysis of collected number plate data during O-D survey. A comparative study of the influence factors indicated that the state of Gujarat, where the project stretch lies is the major influence region for all the vehicles as shown in Table - 16.

**Table 16: State wise vehicle contribution**

Vehicle Type	% Gujarat vehicles
Car	99%
Bus	100%
Mini Bus	100%
Mini LCV	91%
LCV	94%
2 Axle	95%
3 Axle	90%
M Axle	83%

## 5 Parking Survey

Parking studies are necessary to identify locations of intense parking activity, duration, and accumulation of different types of vehicles parked at locations to provide report and data in relation to a planning application for the redevelopment of the site. The data collected from parking studies are useful in determining the need of off-street and on street parking facilities and their pricing. Parking accumulation surveys are carried out to count of the number of vehicles parked within a defined zone at regular predetermined time intervals. Typically, a field observer walks through the area for counting and recording the number of vehicles present per zone on each interval. Site visitation cycle time is usually set to the signed parking time limit or a subset, like 1 hour restriction may have a 1-hour cycle or 30- or 15-minute cycles. Parking duration surveys are to depict, subject to cycle frequency sensitivity, demand of duration of stay of vehicles. This may assist in determining the demand for long term vehicle parking. Preliminary parking studies indicated roadside parking activity at many locations like Lakhigam village, Reliance material gate no – 1, 2, 3 and 4, Sterling Auxiliaries Pvt. Ltd, IDPL chokdi, Golden Chokdi, Uibrant trade avenues Pvt. Ltd, BASF India Pvt. Ltd. and Hidalgo Industries Pvt. Ltd along the project road. The parking analysis is presented in Table – 17 and parking accumulation curves are given in **Annexure – 4**. Intense parking activity is found from 12.00 PM to 18.30 PM with the maximum number of vehicles parked for almost 2 hours duration in peak hour addressing the need for planning of parking lots. The accumulated parking activity curve is presented in Figure 7.

**Table 17: Pedestrian flows along the road**

S. No.	Location	No. of Vehicles Parked per day	Average parking time in mins	Peak hour	No. of Vehicles Parked during peak hour
1	Industrial locations	1891	109.19	16.00 to 17.00	241

**Figure 7: Parking Accumulation Curve**

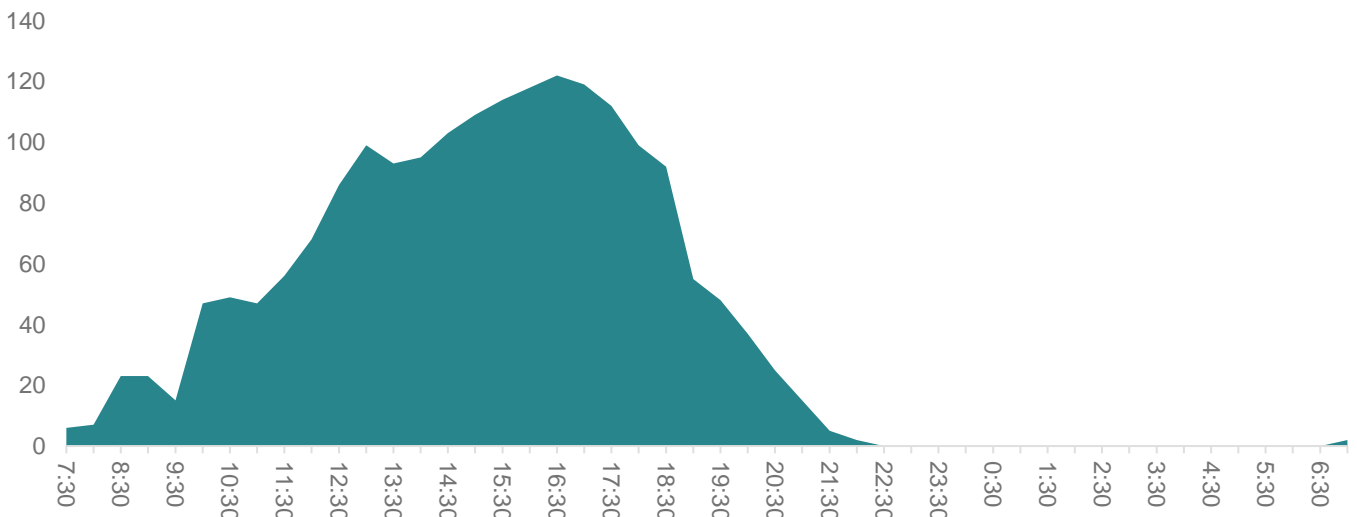

## 6 Turning Movement Survey and Junction Improvement

The mid-block traffic volume count station is located to capture the pattern of the traffic plying on the project road. Apart from these traffic volume counts, for the study of the road network around the project corridor, two major junctions are identified for the turning movement surveys. The traffic pattern is considerably influenced by these junctions, either in case of passenger vehicles or goods or both. 24 hours mode wise turning movement counts have been taken on all the legs of these junctions. The leg wise and direction wise classified traffic volume counts are presented in Figure 8 and 9 and the detailed calculations are provided in **Annexure – 5**.

**Figure 8: Dahej Amod chowk junction**

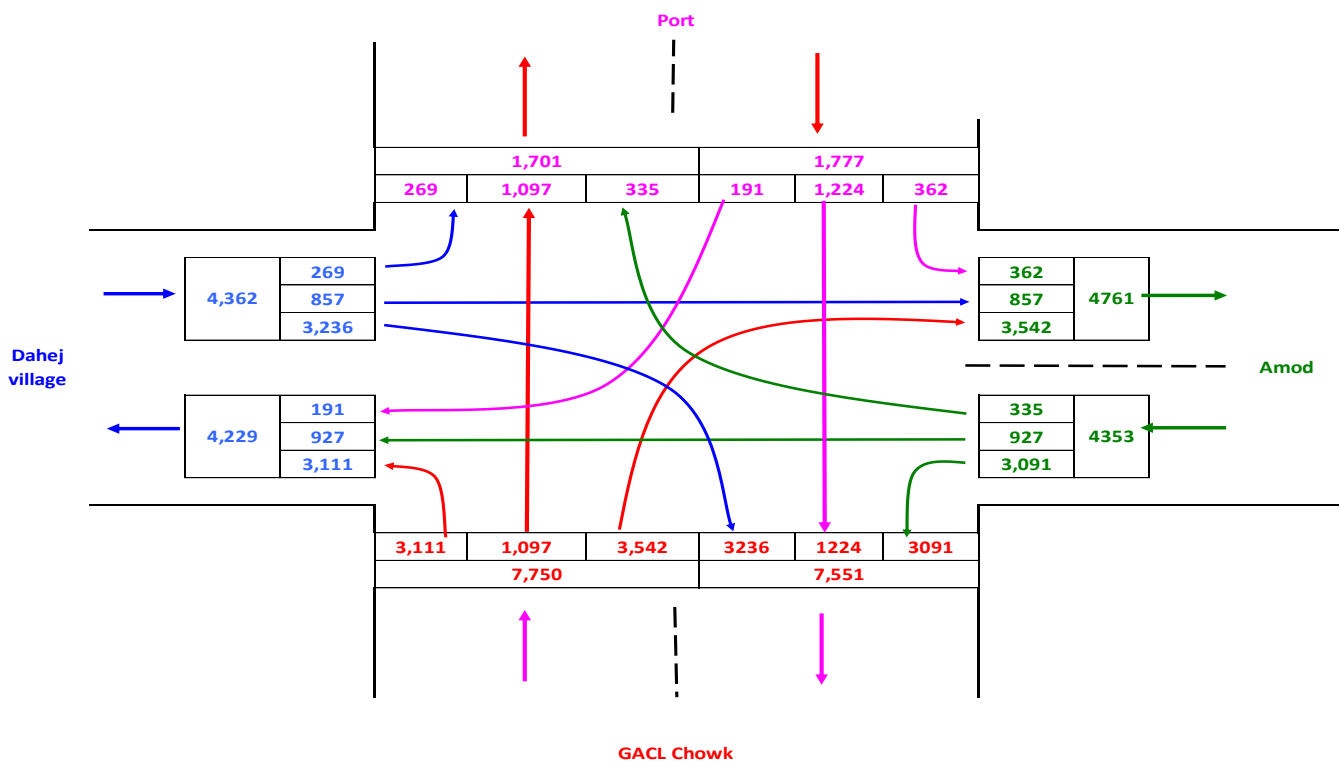



**Figure 9: GACL Chokdi junction**

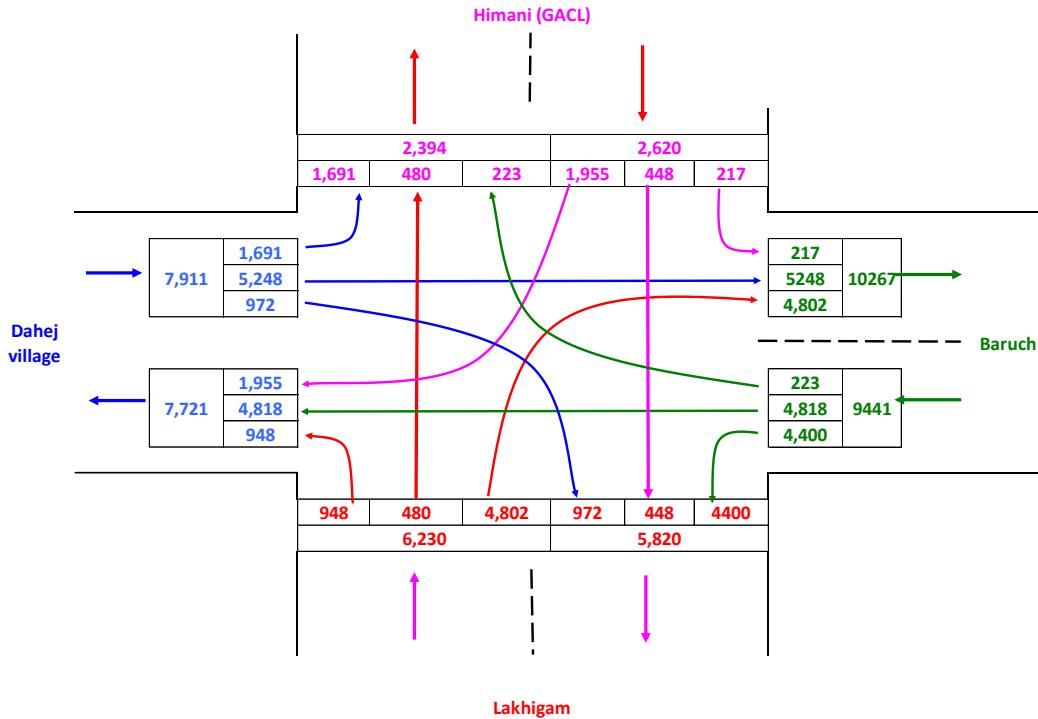

A road junction is a location where multiple roads intersect, allowing vehicular traffic to change from one road to another. Managing the flow of traffic across the junction became of increasing importance, to minimize junction delays, vehicle operating costs and to improve the safety of the road users. As per IRC: 65 -1976 and IRC: SP: 41 – 1994, the junction improvement along the project may be suggested based on the peak hour traffic volume. As per IRC: 92-1985, grade separation may be justified when the total traffic of all the arms of the intersection is in excess of 10,000 PCU's per peak hour. As per IRC: 62-1976, Grade separation should be provided at intersections of divided rural highways if the ADT (fast vehicles only) on the cross road within the next 5 years exceeds 5000. As per IRC: SP: 84-2014 - Clause 2.13.2, Vehicular underpass is to be provided if the cross road is a national or state highway in case of 4 lane divided carriageway facility. As per IRC: SP: 87-2013 - Clause 2.13.2, Vehicular underpass is to be provided if the cross road is a national or state highway in case of 6 lane divided carriageway facility. Such under/over pass shall also be provided across other categories of roads as per site requirements for crossing of traffic. The junction improvement along the project stretch suggested based on the peak hour traffic volume is presented in Table – 18.

**Table 18: Junction improvement**

S. No.	Name/ Ch. of the Junction	Type of Junction	Peak hour	Peak Hour Traffic (Veh)	Peak Hour Traffic (PCU)	Junction Improvement
1	Dahej Amod chowk junction	4 Legged	07.45 to 08.45	1392	1680	As per IRC: 65, Rotary intersection is warranted, as the junction peak hour traffic

						is more than 500 and less than 3000 vehicles.
2	GACL chowk junction	4 Legged	08.15 to 09.15	2272	3347	As per IRC: 65, Rotary intersection is warranted, as the junction peak hour traffic is more than 500 and less than 3000 vehicles.

## 7 Traffic Forecast

### 7.1 Secondary Data Collection

The most important parameter, on which the future forecast of traffic depends, is the growth rate. However, for small stretches where most of the traffic neither originates nor ends within the stretch, growth potential of the origin and destination (Zone of Influence) need to be assessed to arrive at the growth potential of the stretch. It is ideal to identify future growth potential of each zone for goods and passenger movements and for each category of vehicles separately. The past motor vehicle registration data at the state level provides a valuable indication regarding the trends in the traffic growth and presents a dependable tool for estimating future growth rates in different categories of vehicles. To arrive at a realistic and rational assessment of growth factor, efforts have been made to collect various secondary data and statistical information. The analyzed traffic data from the primary surveys and processed data from secondary sources pertaining to the project stretch together provide basic input for design and future traffic projection. The statistical data of economic indicators of Gujarat state has been collected for the period 2011 -2018 as shown in Table - 19 at 2011-12 constant prices are collected from [www.StatisticsTimes.com](http://www.StatisticsTimes.com) and vehicle registration data is collected from Road transport year books (2011-2018) issued by Transport research wing, Ministry of shipping, Road transport & Highways, Government of India.

**Table 19: Vehicle registration and economic indicators**

S. No	Year	Vehicle Registration statistics				Economic indicators			
		Car/Jeep	Truck	2-Wheeler	Bus	GSDP (Rs in Cr)	PCI (Rs)	Pop (in 000's)	NSDP (Rs in Cr)
1	2011-12	1579889	750491	10512304	67546	615606	87481	60906	532809
2	2012-13	1776218	818614	11502959	69846	682650	96683	61713	596659
3	2013-14	1953552	876576	12507289	72015	734284	102589	62530	641489
4	2014-15	2200627	943109	13723200	75075	811428	111370	63359	705629
5	2015-16	2457543	1010996	14934722	79263	894465	120683	64199	774775
6	2016-17	2728095	1076131	16168611	83962	981342	129738	65049	843930
7	2017-18	3037539	1143278	17450305	89046	1086570	142068	66624	946511
8	2018-19	3311120	1226385	18716125	94184	1186379	155256	66784	1036859
<b>Average Yearly Growth Rate %</b>		<b>11.16</b>	<b>7.27</b>	<b>8.59</b>	<b>4.87</b>	<b>9.83</b>	<b>8.55</b>	<b>1.33</b>	<b>9.99</b>

Note: GSDP – Gross State Domestic Product, NSDP – Net State Domestic Product, PCI- Per Capita Income, Pop – Population

## 7.2 Transport demand elasticity – Econometric models

A more rational method will be to establish a relationship between the socio-economic variables such as Population, Net State Domestic Product (NSDP) and Per-Capita Income (PCI) on the one hand and the past registration data of different categories of vehicles on the other to determine the elasticity of transport demand with respect to different categories of vehicles. According to IRC: 108 - 2015, an econometric model could be derived in the form

$$\text{Log}_e P = A_0 + A_1 \text{Log}_e (E.I)$$

Where:

P = number of vehicles of any particular category;

E. I = Economic Indicator such as NSDP, Per-capita income or Population;

A<sub>0</sub> = Constant;

A<sub>1</sub> = Regression coefficient (Elasticity value).

Based on future economic growth prospects in terms of state income, per-capita income and population growth of the project influenced district or state, the future traffic growth rate by vehicle type is estimated by suitably adjusting the elasticity values.

Empirically, traffic growth rate is worked out using the following expression:

$$T_{GR} = E \times ZE_{GR}$$

Where,

T<sub>GR</sub> = Traffic growth rate for a particular mode;

ZE<sub>GR</sub> = Zonal economic growth rates by mode; and

E = Elasticity value for the corresponding mode.

The growth factor derived from past traffic data on the stretch supplemented by registration trend and the statistical parameters would have been the ideal method. However, due to irregular, erratic and insufficient past traffic data available, the derivation of elasticity and growth factors was based on registration data of vehicles and the economic parameters.

The growth trend has been derived for the following categories of vehicles:

Pv = Passenger Vehicles (Car, jeep, Taxi, Van, etc.)

T = Trucks (LCV, 2 Axle, 3 Axle and M Axle)

B = Bus, Mini Bus

The following steps have been adopted to derive the elasticity and growth factors

- Growth rate of registered vehicles in zone of influence is found out.
- Growth rates of NSDP/GSDP, Per Capita Income and population are obtained.
- For passenger vehicles and buses, number of registered vehicles has been regressed with population data of the state.
- For trucks, number of registered trucks has been regressed with NSDP.

The elasticity analysis in terms of econometric models at Gujarat state level is presented in Table - 20. The regression coefficients indicate that there is a good correlation between the socio-economic parameters and past vehicle registration data. Detailed calculations are given in **Annexure – 6**.

**Table 20: Elasticity Analysis**

S. No.	Vehicle Type	Economic Indicator	Elasticity Value	R <sup>2</sup> Value
1	Car/Jeep	PCI	1.33	0.997
2	Truck	NSDP	0.73	0.996
3	2-Wheeler	PCI	1.03	0.995
4	Bus	Population	3.47	0.981

## 7.3 Elasticity of Transport Demand Values - Road Development Plan, Vision 2021

Experience reveals that the growth rates of passenger and goods vehicles grow at different rates. This phenomenon is primarily because of varying levels of relationships between economy and/ or socio-economic parameters and traffic growth rates, and therefore, the elasticity values need to be graded differently by modes such as car, bus, truck etc. In this regard, MoSRTTH, Government of India in its document “Road Development Plan, Vision 2021” recommends elasticity values shown in Table - 21 for forecasting traffic on rural highways. The declining rate of elasticity value is commonly used as this reduces the impact of future uncertainties on prediction.

**Table 21: Elasticity Values**

Vehicle Type	2021-26	2026-31	2031-36	2036-41
Car	1.3	1.2	1.1	1.0
Bus	1.1	1.1	1.0	1.0
Truck	1.1	1.1	1.0	1.0

The average traffic growth rates calculated for different category of vehicles based on econometric models and trend growth of vehicles are presented in Table – 22. As the past traffic data was not as classified as what is made in this project, adoption appropriate growth rates by modes of traffic stream as derived from models are made. In the case of past registered commercial vehicles like 2/3 Axle truck, LCV and Mini LCV, only total no. is available but not the bifurcated values. For predicting local traffic like tractors and other goods vehicles, a growth rate of 3% has been adopted as per IRC: 102-1998. Non-motorized traffic (NMT) has been grown at 2% as its growth has been frozen at this level. As per 2/4/6 laning manual, the growth rate of commercial vehicles should not be less than 5% at any point of time. These points are considered in the finalization of the same. With limited available past data, fluctuating

developing economy, traffic forecasting could be quite tricky, subjective, pessimistic and approximate. Future pattern of change in Population, NSDP, Vehicle ownership, fuel consumption, per capita Income, etc. can be estimated with limited degree of accuracy. As the future can't be predicted exactly, traffic growth rates have been decreased by 1% for every 5-year future span.

**Table 22: Projected Traffic growth rates**

S.No.	Period	2W	Car/ jeep	Bus	Trucks				
					2 Axle	3 Axle	M Axle	LCV	Mini LCV
1	Up to 2023	9.0	10.0	5.0	5.0	7.0	7.0	7.0	7.0
2	2024 -2028	8.0	9.0	4.0	5.0	6.0	6.0	6.0	6.0
3	2029 – 2033	7.0	8.0	3.0	5.0	5.0	5.0	5.0	5.0
4	2034 – 2038	6.0	7.0	3.0	5.0	5.0	5.0	5.0	5.0
5	Beyond 2038	5.0	6.0	3.0	5.0	5.0	5.0	5.0	5.0

## 8 Traffic Projections and Road Capacity

Based on the estimated traffic growth rates as per **Table 22** and the Annual Average Daily Traffic (AADT) observed at the TVC location, the total traffic on project road for the horizon years is estimated as given in **Annexure – 7**. PCU factors have been used as given in **Table 2** for different vehicle types to convert the total traffic to total traffic in PCU.

**Figure 10: Total Traffic and Capacity Projection**

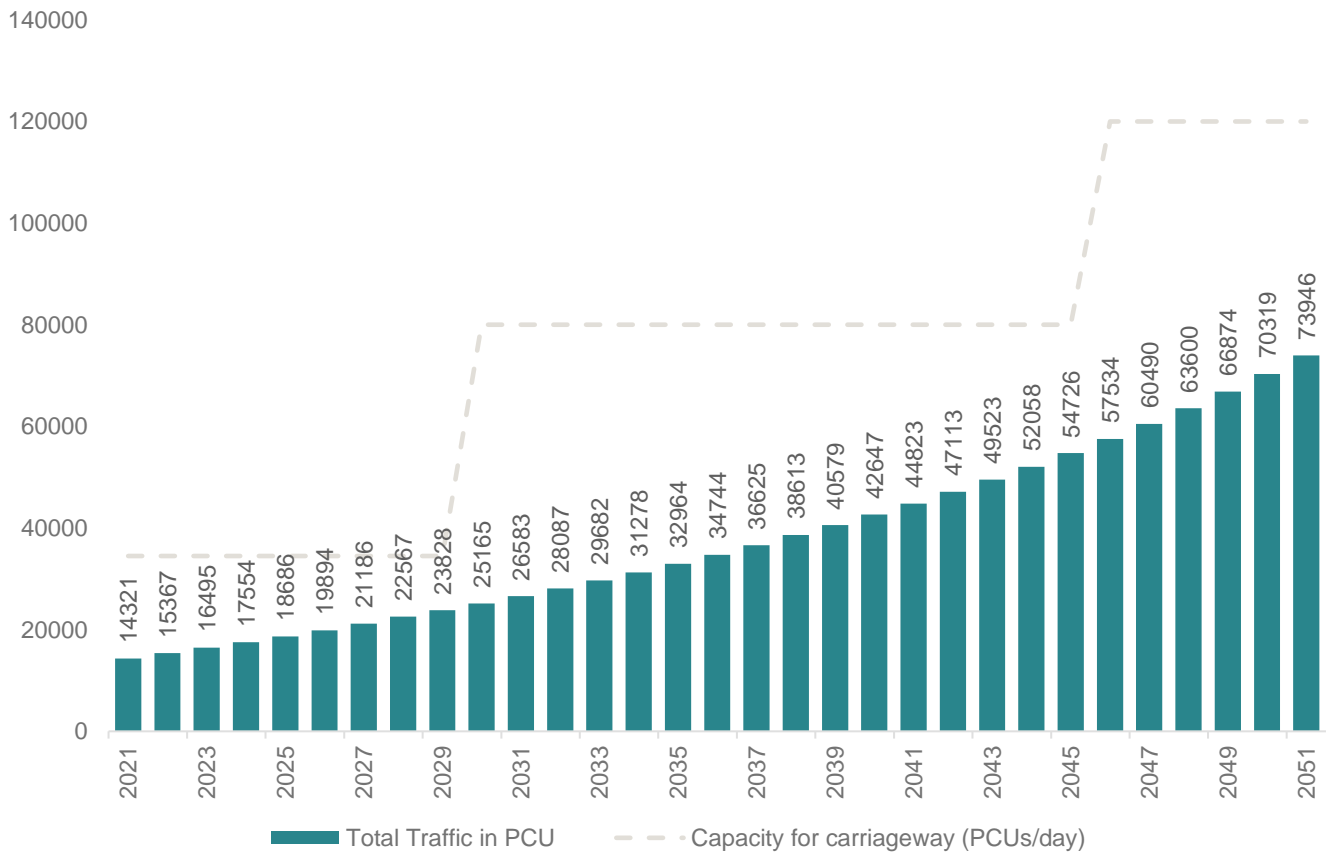

Following is a representation of the V/C ratio and Level of Service, based on the total traffic volume in numbers, total traffic in PCU and capacity for carriageway.

**Table 23: Projected V/C Ratio and Level of Service**

Year	Volume-Capacity (V/C) Ratio	Level of Service (LOS)	Recommendation based on V/C ratio
2021	0.42	B	2 Lane undivided carriageway with paved shoulders
2022	0.45	B	
2023	0.48	B	

2024	0.51	C	
2025	0.54	C	
2026	0.58	C	
2027	0.61	C	
2028	0.65	C	
2029	0.69	C	
2030	0.31	B	4 Lane divided carriageway
2031	0.33	B	
2032	0.35	B	
2033	0.37	B	
2034	0.39	B	
2035	0.41	B	
2036	0.43	B	
2037	0.46	B	
2038	0.48	B	
2039	0.51	C	
2040	0.53	C	
2041	0.56	C	
2042	0.59	C	
2043	0.62	C	
2044	0.65	C	
2045	0.68	C	
2046	0.48	B	6 Lane divided carriageway
2047	0.50	C	
2048	0.53	C	
2049	0.56	C	
2050	0.59	C	
2051	0.62	C	



## 9 Road Inventory and Condition Survey

Road inventory and condition survey provides basic information needed for effective transportation and road system planning, management, operations and maintenance. The scope of improvement measures on the existing road and widening proposals with economic justification depends upon the condition of the existing road. Detailed surveys/investigations of the existing road were conducted on project road of SH-206 in order to prepare the road inventory and condition survey report for appropriate improvement proposal.

An inventory of the project road has been carried out by visual observations supplemented with sample measurements using measuring tape, scale and straight edge. Km wise features like terrain, land-use, pavement type & condition and carriageway width, shoulder type, condition & width, nature of soil, height of embankment or depth of cut, cross drainage structures, general drainage conditions etc., have been recorded. The details of road inventory survey collected per Km, including the carrying capacity, and width and lanes of the road, are presented in **Annexure – 8**.

It is found from the inventory survey that the terrain of the road is in plain terrain category. The majority of adjoining lands are used for commercial purposes. 60% of the land use is commercial, 30% is classified as barren land and the rest is built-up at village limits. The existing two-lane carriageway width is 7.0m with paved shoulders of varying width on either side. The existing pavement is of flexible type with bituminous surface up to 50% and the remaining is of CC type. The earthen shoulder is observed on either side of the carriageway to some extent. The road embankment is found in good to fair condition on both sides and the height of embankment varies from 0.5m to 1.5m. Pavement distress conditions like cracking, raveling, edge fretting and pot-holes are found to some extent and occupies 20% of pavement area. The general condition of the pavement is found to be in good to fair condition throughout the project road.

## 10 Conclusion

The road from Bharuch to Dahej, State Highway (SH-6) is four-lane road and road connecting state highway to plant (SH-206) is also four lane cement concrete (CC) road which are in good condition and regular maintenance is carried out by Gujarat Govt. During construction phase of third jetty project there will be increase in road traffic of approximately 25 no. vehicles per day for transportation of construction material and personal. However, this movement will be limited for short period of time and daily movement will be spread over 24 hrs time. Existing road infrastructure is capable to handle the additional load of these vehicles. During operation phase, regasified LNG (RLNG) will be transported to customers through dedicated underground pipelines and no surface movement is envisaged."

# Infrastructure Advisory

## About CRISIL

CRISIL is a global analytical company providing ratings, research, and risk and policy advisory services. We are India's leading ratings agency. We are also the foremost provider of high-end research to the world's largest banks and leading corporations.

CRISIL is majority owned by S&P Global Inc., a leading provider of transparent and independent ratings, benchmarks, analytics and data to the capital and commodity markets worldwide.

## About CRISIL Infrastructure Advisory

CRISIL Infrastructure Advisory is a leading advisor to regulators and governments, multilateral agencies, investors, and large public and private sector firms. We help shape public policy and enable infrastructure development. Our services span a wide array of infrastructure development activities. Our work in the areas of policy formulation, regulation, design and implementation of public-private partnership (PPP) frameworks and infrastructure financing mechanisms helps create a vibrant ecosystem for infrastructure development. Our services at the project level include bid process management, valuations and due diligence to enable investment decisions. We are known for our core values of independence and analytical rigor combined with deep domain expertise. Our teams have expertise across the complete range of infrastructure sectors - urban development, energy, transport and logistics, natural resources, education, and healthcare. We have a rich understanding of PPP and financing related issues. We operate in India and 22 other emerging economies in Asia, Africa, and the Middle East. CRISIL Infrastructure Advisory is a division of CRISIL Risk and Infrastructure Solutions Limited, a wholly owned subsidiary of CRISIL Limited.

## CRISIL Privacy Notice

CRISIL respects your privacy. We use your contact information, such as your name, address, and email id, to fulfil your request and service your account and to provide you with additional information from CRISIL and other parts of S&P Global Inc. and its subsidiaries (collectively, the "Company") you may find of interest.

For further information, or to let us know your preferences with respect to receiving marketing materials, please visit [www.crisil.com/privacy](http://www.crisil.com/privacy). You can view the Company's Customer Privacy at <https://www.spglobal.com/privacy>

**Last updated: October 2020**

## Disclaimer

This report is prepared by CRISIL Risk and Infrastructure Solutions Limited (CRIS). This report may have been prepared by CRIS at the request of a client of CRIS (client). This report may include or refer to information and materials provided by the client and/or obtained by CRIS from sources that CRIS considers reliable (together, "materials"). In preparing this report, CRIS does not independently validate any such materials and assumes those materials are accurate. CRIS does not guarantee the accuracy, adequacy or completeness of any material contained in or referred to in the report. While CRIS takes reasonable care in preparing the report, CRIS shall not be responsible for any errors or omissions in or for the results obtained from the use of or the decisions made based on, the report. The user takes full responsibility for the use of and the decisions made based on the report. While portions of materials are included in the report, CRIS makes all reasonable attempts to attribute credits to the source of the materials; however, even if a particular source of a material is not so attributed, CRIS stakes no claim to any such material in the form as provided to or made accessible to CRIS. No third party whose material is included or referenced in this report under credit to it, assumes any liability towards the user with respect to such material. Neither CRIS nor its directors, employees and representatives accept any liability with regard to any access, use of or reliance on, the report and that CRIS expressly disclaim all such liability. Any third party brands, names or trademarks contained in the report belong to the relevant third parties. The report contains CRIS' view as at the date of the report based on available material. CRIS does not assume an obligation to update the report where updated materials are available or to notify anyone that an updated report is available. This report may not be reproduced or redistributed or communicated directly or indirectly in any form or published or copied in whole or in part except as authorized by CRIS. Unless CRIS has expressly agreed in writing, this report is not intended for use outside India. By accessing and/or using any part of the report, the user accepts the foregoing disclaimers and exclusion of liability which operates to the benefit. CRISIL or its associates may have other commercial transactions with the company/entity.



**PETRONET  
LNG  
LIMITED**

# **OIL SPILL CONTINGENCY PLAN (OSCP)**

**for**

## **DAHEJ LNG PORT TERMINAL**

**March 2022**

### **Dahej LNG Port Terminal Petronet LNG Ltd.**

Plot No 7/A, GIDC Industrial Estate, Dahej, Taluka Vagra  
Dist. Bharuch, Gujarat - 392 130 INDIA  
Tel: +91 2641 670200,  
Email: [shipping@petronetlng.in](mailto:shipping@petronetlng.in)

Section : 00	Oil Spill Contingency Plan	Page no. 01 of 108
Approved By:	Dahej LNG Port Terminal	Revision No. : 01 Issue No. : 00 Date: 01 Mar' 2022

## FOREWORD

As per the latest NOSDCP guidelines, all ports, oil companies and other oil handling agencies are required to be ready for any eventual oil spill in their operational area. The first step in this direction is carrying out an Oil Spill Risk Assessment and preparation of Oil Spill Contingency Plan.

The contingency plans is the overarching document that embodies the Government response policy and the national/state/local level response organizations for responding to various types of disasters that may affect the local populace and also the flora and fauna. Certain types of pollution causes irreparable damage to the local eco system which sustains large food chain and life cycle.

The ecosystem has large varieties of flora and fauna and also provides a sustainable habitat for a wide variety of vegetation & wildlife. The Indian constitution and various legislation such as Forest Act, Wildlife Protection Act, Environment Protection Act 1986, Water Act 1974, empowers various authorities to take necessary prevention and protection steps. However, for a developing country like India, developmental activities are taking place at a faster rate and in most cases directly affect the environmental protection principles. Pollution is the major byproduct of the developmental activities. Oil pollution has become a major threat to the coastal areas due to the risks associated with the sea transportation and the increased importation of crude oil in India.

The coast of Gujarat now faces increased threat from oil spill from the passing ships, port activities, petro chemical exploration and exploitation activities. The need of the hour is for establishment of an institutional arrangement through a Contingency Plan to address oil spill emergency that may affect the coastline and take necessary preventive measures to protect the highly sensitive areas and other shorelines of the state of Gujarat.

This Local contingency Plan specifies the necessary steps/actions that needs to be taken by the State Environment Ministry, District Collectors, State Pollution Control Boards, State Maritime Boards, Fisheries Department, Forest Department, Ports and other stake holders pertaining to their role during an unfortunate incident of a spill washing ashore the coastal areas of Gujarat.

This Local contingency Plan has been made with the inputs from the Indian Coast Guard and other relevant agencies. The plan will be reviewed on a regular basis however any suggestions for improvement are always welcome.

Section : 00	Oil Spill Contingency Plan	Page no. 02 of 108
Approved By:	Dahej LNG Port Terminal	Revision No. : 00 Issue No. : 00 Date: 21 Nov' 2016

## ABBREVIATION & ACRONYM

PLL	- Petronet LNG Ltd.
ECR	- Emergency Control Room
ERP	- Emergency Response Procedure
ERT	- Emergency Response Team
EST	- Emergency Shut Down
FIR	- First Information Report
GMB	- Gujarat Maritime Board
GPCB	- Gujarat Pollution Control Board
HSD	- High Speed Diesel
IC	- Incident Controller
ICG	- Indian Coast Guard
IMO	- International Maritime Organization
IPIECA	- International Petroleum Industry Environmental Conservation Association
LWS	- Low Water State
MCLS	- Maximum Credible Loss Scenario
MMD	- Mercantile Maritime Department
MOEF	- Ministry of Environment and Forest
NIO	- National Institute of Oceanography
NOAA	- National Oceanic and Atmospheric Administrative
NOS-DCP	- National Oil Spill Disaster Contingency Plan.
OISD	- Oil Industries Safety Directorate
OPRC	- The International Convention on Oil Pollution Preparedness Response and Cooperation, 1990
OSC	- On Scene Co-coordinator / Commander
OSCP	- Oil Spill Contingency Plan
OSD	- Oil Spill Dispersant
OSR	- Oil Spill Response
OSV	- Offshore Support / Supply Vessel
POLREP	- Pollution Report
PRO	- Public Relation Officer

Section : 00	Oil Spill Contingency Plan	Page no. 03 of 108
Approved By:	Dahej LNG Port Terminal	Revision No. : 00 Issue No. : 00 Date: 21 Nov' 2016

## DOCUMENT CONTROL

- 1.0 This document is the property of **Dahej LNG Terminal - Petronet LNG Ltd.**, hereinafter referred to as **PLL**, and shall not be removed from the Company's premises.
- 2.0 When the controlled copy holder ceases to be the authorized recipient of this document, the document should be returned to the Plant Head, Dahej Office.
- 3.0 This document is distributed as per given below list. However, documents on a "need based" basis will be distributed. As per the provision of NOS-DCP, the OSCP will be approved by the Indian Coast Guard before distribution.

S. N.	Document Holders	Copy No.	Date of Issue
1.	Plant Head	01	
2.	Management Representative	02	
3.	HOD, Port Operations	03	
4.	HOD, HSE / Fire Safety	04	
5.	Shift Duty Officer	05	
6.	Coast Guard	06	
7.	Marine Control Room	Original Copy	
8.	Masters of vessels / ships	08-09	

- 4.0 All documents so distributed will be controlled documents and identified by a unique control number as per above mentioned list in i.e. para no. 3.0.
- 5.0 The holder of the control copy shall ensure that the persons working under him, who are responsible for any activity described in this document, are made aware of such responsibility. These persons shall be given this document to read and as acknowledgment of having read shall sign the **OSCP – "Record of Circulation"** page of this document.
- 6.0 All persons to whom the documents have been circulated shall also be made aware of any revisions thereto by the holder of the controlled copy of document. The person shall, after reading, sign in the **OSCP - "Record of Circulation"** page of this document as acknowledgment of having read and understood the document.
- 7.0 Staff at PLL, Dahej shall sign in the control copy issued to Control Room (**Copy no. 07**)

Section : 00	Oil Spill Contingency Plan	Page no. 04 of 108
Approved By:	Dahej LNG Port Terminal	Revision No. : 00 Issue No. : 00 Date: 21 Nov' 2016





## RECORD OF AMENDMENTS

Sl. No.	Amendment Number	Details of Amendment	Authority	Date	Name & Signature of number of the person who carried out the Amendment

Section : 00	Oil Spill Contingency Plan	Page no. 06 of 108
Approved By:	Dahej LNG Port Terminal	Revision No. : 00 Issue No. : 00 Date: 21 Nov' 2016

## CONTENTS

### TABLE OF CONTENTS

### PAGE NO.

#### PART- I      STRATEGY

#### **1. INTRODUCTION**

i) Petronet (Dahej) description	12
ii) Basis	19
1.1 Authorities and Responsibilities	20
1.2 Coordinating Committee	21
1.3 Statutory Requirements	22
1.4 Mutual Aid Agreements	22
1.5 Geographical Limits of Plan	22
1.6 Interface with ROS DCP and NOS DCP	23

#### **2. RISK ASSESSMENT**

2.1 Identification of activities and risks	25
2.1.1 Berthing Incident (Jetty)	25
2.1.2 Tug Impact	25
2.1.3 Collision between Vessels Underway	25
2.1.4 Ship Grounding	26
2.1.5 Fire and Explosion	26
2.1.6 Spillage from Pipelines	26
2.1.7 Spillages of Fuel Oil	26
2.2 Types of Oil Likely to be spilled	27
2.3 Probable Fate of Spilled Oil	28
2.4 Development of Oil Spill Scenarios Including worst case discharge	28
2.5 Shoreline Sensitivity Mapping	28
2.6 Shoreline Resources, Priorities for Protection	29
2.7 Special Local Considerations	29

#### **3. RESPONSE STRATEGY**

3.1 Philosophy and Objectives	32
3.1.1 Response Planning Policies	34
3.1.2 Response Staging and Mobilisation	34
3.1.3 Oil Spill Classification of Tiered Response	35
3.1.4 Response	35
3.2 Limiting and Adverse Conditions	36
3.3 Oil Spill Response in Offshore Zones	36

Section : 00	Oil Spill Contingency Plan	Page no. 07 of 108
Approved By:	Dahej LNG Port Terminal	Revision No. : 00 Issue No. : 00 Date: 21 Nov' 2016

3.4	Oil Spill Response in Coastal Zones	36
3.5	Shoreline Oil Spill Response	36
3.6	Storage and Disposal of Oil and Oily Waste	36
<b>4.</b>	<b>EQUIPMENT</b>	
4.1	Marine Oil Spill Response Equipment	38
4.2	Inspection, Maintenance and Testing	38
4.3	Shoreline Equipment, Supplies and Services	39
<b>5.</b>	<b>MANAGEMENT, MANPOWER AND TRAINING</b>	
5.1	Crisis Manager and Financial Authorities	41
5.2	Incident Organisation Chart	41
5.3	Manpower Availability (On-Site, On Call)	41
5.4	Availability of Additional Manpower	42
5.5	Advisors and Consultants - Spill Response, Wildlife and Marine Environment	42
5.6	Training / Safety Schedules and Drills / Exercise Programme	42
	5.6.1 Training	42
	5.6.2 Safety	43
<b>6.</b>	<b>COMMUNICATION AND CONTROL</b>	
6.1	Incident Control Room and Facilities	48
6.2	Field Communications Equipment	48
6.3	Reports, Manuals, Maps Charts and Incident logs.	49
<b><u>PART- II</u></b>	<b><u>Action and Operation</u></b>	
<b>7.</b>	<b>INITIAL PROCEDURE</b>	
7.1	Notification of Oil Spill to Concerned Authorities	51
7.2	Preliminary Estimate of Response Tier	51
7.3	Notifying Key Team Members and Authorities	52
7.4	Manning Control Room	52
7.5	Collecting information (oil type, sea /wind forecast, aerial surveillance, beach reports)	52
7.6	Estimating fate of oil slick (24, 48 & 72 hours)	53
7.7	Identifying resources immediately at risk, informing parties	53
<b>8.</b>	<b>RESPONSE OPERATIONS</b>	
8.1	Assembling Full Response Team	55
8.2	Identifying Immediate Response Priorities	61
8.3	Mobilising Immediate Response	61

Section : 00	Oil Spill Contingency Plan	Page no. 08 of 108
Approved By:	Dahej LNG Port Terminal	Revision No. : 00 Issue No. : 00 Date: 21 Nov' 2016

8.4	Media Briefing	62
8.5	Planning Medium Term Operations (24, 48 & 72 hour)	62
8.6	Deciding to Escalate Response to Higher Tier	62
8.7	Mobilising or Placing on Standby Resources required	63
8.8	Establishing Field Command Post and Communications	63
<b>9.</b>	<b>CONTROL OF OPERATIONS</b>	
9.1	Establishing a Management Team with Experts and Advisors	65
9.2	Upgrading Information (sea /wind /weather forecasts, aerial surveillance, beach reports)	65
9.3	Reviewing and Planning Operations	65
9.4	Obtaining Additional Equipment, Supplies and Manpower	65
9.5	Preparing Daily Incident Log and Management Reports	66
9.6	Preparing Operations Accounting and Financing Reports	66
9.7	Preparing Releases for Public and Press Conferences	67
9.8	Briefing Local and Government officials	67
<b>10.</b>	<b>TERMINATION OF OPERATIONS</b>	
10.1	Deciding Final and Optimal Levels of Beach Clean-up	69
10.2	Standing-down, Equipment, Cleaning, Maintaining, Replacing	69
10.3	Preparing Formal Detailed Report	69
10.4	Reviewing Plans and Procedures from Lessons Learnt	69

Section : 00	Oil Spill Contingency Plan	Page no. 09 of 108
Approved By:	Dahej LNG Port Terminal	Revision No. : 00 Issue No. : 00 Date: 21 Nov' 2016

## APPENDICES

APPENDIX - 01	Geographic Limites of Plan
APPENDIX - 02	Sensitive Coastal Areas as per Coast Guard Website
APPENDIX - 03	Mud Flats Shoreline Clean-up Techniques
APPENDIX - 04	Current Directions
APPENDIX - 05	Oil Spill Response Decision Tree
APPENDIX - 06	Option for Separation and Disposal of Oil & Debris
APPENDIX - 07	GPCB approved Oil Recyclers
APPENDIX - 08	List of Tier-1OSR Equipment
APPENDIX - 09	List of Shoreline Cleanup Equipment and Materials
APPENDIX - 10	Incident Organisation Chart
APPENDIX -11	Advisor and Consultants List
APPENDIX -12	Training and Competency
APPENDIX -13	Oil Spill Report Forms
APPENDIX -14	Personal Log Form
APPENDIX -15	Communication Channel
APPENDIX -16	Telephone Directory
APPENDIX -17	Afloat & Ashore OSR Teams
APPENDIX -18	Initial Press Statement
APPENDIX -19	Daily Incident Log

Section : 00	Oil Spill Contingency Plan	Page no. 10 of 108
Approved By:	Dahej LNG Port Terminal	Revision No. : 00 Issue No. : 00 Date: 21 Nov' 2016

# **PART - I**

# **STRATEGY**

## **CHAPTER - 1**

## **INTRODUCTION**

Section : 01	Oil Spill Contingency Plan	Page no. 11 of 108
Approved By:	Dahej LNG Port Terminal	Revision No. : 00 Issue No. : 00 Date: 21 Nov' 2016

## 1. INTRODUCTION

### I) ABOUT DAHEJ LNG TERMINAL

The Petronet LNG Ltd has set up South East Asia's first LNG Receiving and Regasification Terminal with an original nameplate capacity of 5 MMTPA at Dahej, Gujarat. The infrastructure was developed in the shortest possible time and at a benchmark cost. The capacity of the terminal has been expanded to 10 MMTPA in June, 2009, 15 MMTPA in August 2016 and to the current capacity of 17.5 MMTPA in June 2019. The expansion involved construction of four additional LNG storage tanks and other vaporization facilities. The terminal is currently meeting around 40% of the total gas demand of the country.

The Company has completed and commissioned the second LNG Jetty at Dahej. The second LNG Jetty is required for risk mitigation as well as to berth the higher capacity Q-Max and Q-Flex LNG vessels.

#### A. PETRONET LNG LIMITED OVERVIEW

Petronet LNG Limited, one of the fastest growing world-class companies in the Indian energy sector, has set up the country's first LNG receiving and regasification terminal at Dahej, Gujarat, and another terminal at Kochi, Kerala. While the Dahej terminal has a nominal capacity of 17.5 MMTPA, the Kochi terminal has a capacity of 5 MMTPA.

Petronet LNG is at the forefront of India's all-out national drive to ensure the country's energy security in the years to come.

Formed as a Joint Venture by the Government of India to import LNG and set up LNG terminals in the country, it involves India's leading oil and natural gas industry players. Our promoters are GAIL (India) Limited (GAIL), Oil & Natural Gas Corporation Limited (ONGC), Indian Oil Corporation Limited (IOCL) and Bharat Petroleum Corporation Limited (BPCL).

PLL signed Port Operation Services Agreement with M/s. Sparkle Terminal and Towage Services Limited. The Port Operator owns and operates Tug Boats and Pilot Boat and undertakes safe towing, mooring & pilotage of the LNG Tankers and maintenance of jetty facilities at Dahej LNG terminal. The pilots engaged by Port Operator have thorough local knowledge and have undergone simulation training for smooth, safe and efficient berthing for all types of LNG vessel larger Q Flex, Q Max vessels.

Section : 01	Oil Spill Contingency Plan	Page no. 12 of 108
Approved By:	Dahej LNG Port Terminal	Revision No. : 01 Issue No. : 00 Date: 01 Mar' 2022

Petronet LNG Limited has entered into Marketing Alliance for the entire throughput quantity of 7.5 MMTPA (30 MMSCMD) of Regasified-LNG through the Gas Sale & Purchase Agreements with the three Promoter-cum-Offtakers i.e. GAIL (India) Ltd., Indian Oil Corporation Limited and Bharat Petroleum Corporation Limited (Public Sector Undertakings of the Government of India) in the ratio of 60:30:10 respectively. The three Promoter Companies are classified as "NAVRATNA" Companies of the Government of India considering the strategic nature of their industry and fundamental strengths. For the long term 7.5 MMTPA throughput of Dahej LNG Terminal, GAIL (India) Limited, one of the Promoters-cum-Off takers is the sole transporter. The other Offtakers of regasified LNG viz. IOCL and BPCL uses the pipeline of GAIL (India) Limited by executing Gas Transmission Agreements.

The three off-takers, GAIL (India) Limited (GAIL), Indian Oil Corporation Limited (IOCL) and Bharat Petroleum Corporation Limited (BPCL) have, in turn, signed the Gas Sales Contracts for the supply of Regasified-LNG with their respective consumers.

Mainly, the consumers of Regasified-LNG are the existing consumers, whose current demand is unmet or are currently using liquid fuels, like, Naphtha /FO/ LSHS.

Petronet is also meeting RLNG requirement of bulk consumers like GSPCL, Reliance, Torrent, IFFCO on spot /short term basis. The LNG is being sold by Petronet on Ex-terminal basis.

The LNG is consumed by the existing consumers falling in the States of Gujarat, Maharashtra and other states through GAIL pipeline network consisting of Hazira-Bijaypur-Jagdishpur, Dahej - Uran, Dahej - Vijaipur along with GSPL network.

## **B. DAHEJ LNG MARINE TERMINAL – PETRONET LNG LIMITED (PLL)**

The Dahej LNG Terminal is located in the southern reaches of the Dahej port which itself is situated on the east side of the Gulf of Khambhat, bounded by an area between latitudes 21°44' North and 21°35' North, with western boundary in longitude 072°29' East and from there to the shoreline. The operational area comes under the jurisdiction of GMB.

LNG Terminal offers two 'T' head independent jetties (namely North Jetty & South Jetty), having a separation of 500 m between them measured centre-to-centre of the vapour manifold, Each jetty has associated breasting and mooring dolphins. Each consist of a service platform which is connected to the shore with a trestle of approximately 2.4 Kilometres and provides vehicular access. North Jetty is capable of accepting LNG vessels of up to 220,000 cub m and South Jetty is capable of accepting vessels upto 2,70,000 cub m.

Section : 01	Oil Spill Contingency Plan	Page no. 13 of 108
Approved By:	Dahej LNG Port Terminal	Revision No. : 00 Issue No. : 00 Date: 21 Nov' 2016



<b>NAME OF THE FACILITY</b>	Petronet LNG Limited, Dahej LNG Terminal
<b>LOCATION : (ADDRESS WITH DISTRICT AND TALUKA DETAILS) &amp; LATITUDE LONGITUDE DETAILS</b>	PETRONET LNG LIMITED, GIDC INDUSTRIAL ESTATE, PLOT NO. 7/A, TALUKA : VAGRA, DIST. BHARUCH, GUJARAT - 392130 <b>Latitude</b> : 21°35' - 21°44' N <b>Longitude</b> : 72°29' E
<b>TYPE OF FACILITY</b>	All weather, Private Jetty
<b>DETAILS ABOUT THE INDUSTRY SUPPORTED:</b>	Power, Fertilizer, City Gas, Petro Chem Refinery etc.
<b>TYPE OF COMMODITIES HANDLED</b>	<b>Import</b> - LIQUEFIED NATURAL GAS; <b>Export</b> – NA
<b>TYPE OF VESSELS BUILT: (IN CASE OF SHIPYARD)</b>	NA
<b>RAIL AND ROAD NETWORK</b>	NA
<b>COMMUNICATION WITH STEAMERS</b>	NA
<b>CHARTS</b>	Indian Chart 2082: APPROACHES TO DAHEJ, Indian Chart 2110: DAHEJ HARBOUR
<b>ANCHORAGE</b>	An anchorage is designated for the use of LNG tankers that may have to anchor prior to or after berthing. Vessel should avoid anchoring. However, if it is extremely necessary to do so, LNG Tankers should anchor WEST of Petronet Jetty inside the following designated anchorage area:  <b>Designated Anchorage Area:</b> <ul style="list-style-type: none"> <li>• Lat 21 43.30 N, Long 072 25.00 E</li> <li>• Lat 21 43.30 N, Long 072 28 50 E</li> <li>• Lat 21 35 00 N, Long 072 28 50 E</li> <li>• Lat 21 35 00 N, Long 072 25.00 E</li> </ul> <b>Prohibited Anchorage Area:</b> Ships should not anchor in the area East of the line joining coordinates <ul style="list-style-type: none"> <li>• Lat 21 35.00 N, Long 072 28.50 E</li> <li>• Lat 21 43.30 N, Long 072 28.50 E</li> </ul>

Section : 01	Oil Spill Contingency Plan	Page no. 14 of 108
Approved By:	Dahej LNG Port Terminal	Revision No. : 01 Issue No. : 00 Date: 01 Mar' 2022

	Masters are advised that strong tidal currents are prevalent in the Gulf of Khambhat and great caution must be exercised while anchoring. A continuous and proper anchor watch must be kept at anchorage with Main Engines at short notice. Use of second anchor under foot and picking it up before every change of tide must be considered.
<b>DRAFT (AT THE BERTHING STRUCTURE, TURNING CIRCLE AND CHANNEL)</b>	Sufficient water exists at the jetty to allow a minimum under keel clearance at Chart Datum at ships draught of 12.7 meters.
<b>PILOTAGE</b>	Pilotage is compulsory for all vessels using the Dahej LNG Terminal. Pilot boards the Vessel about 2 hours before the HW / LW in position 2~3 nm SW of the jetty. Vessel speed is to be kept at less than 5 knots while picking up the Pilot.
<b>FEATURES : HHW, MHHW, MLHW, MHLW, MLLW, MSL – IN METRES</b>	Highest Astronomical Tide (HAT) : +10.800 m Highest High Water Spring (HHWS) : +10.200 m Mean Sea Level (MSL) : + 5.100 m Lowest Low Water Spring (LLWS) : + 0.700 m Lowest Astronomical Tide (LAT) : -1.000 m
<b>HARBOUR STRUCTURE: SHOULD INCLUDE DETAILS ABOUT THE NUMBER OF JETTIES / BERTHS, LENGTH &amp; WIDTH OF THE JETTIES</b>	LNG Terminal offers two T head independent jetties, having a separation of 500 m between them measured centre-to-centre of the manifold. Each jetty has associated breasting and mooring dolphins. Each Jetty consists of a service platform which is connected to the shore with a trestle of approximately 2.4 Kilometres and provides vehicular access.  North Jetty is capable of accepting LNG vessels of up to 220,000 cub m and South Jetty is capable of accepting vessels upto 2,70,000 cub m.
<b>NAVIGATIONAL AIDS</b>	For outer approaches in Gulf of Khambhat, a Channel designated as Narmada Channel has been identified for use of LNG Tankers.  This channel is marked with 9 (1 fairway buoy + 8 channel buoys) buoys. The buoys are laid in accordance with IALA Standards.  Inner approaches to LNG jetty in general comprise of

Section : 01	Oil Spill Contingency Plan	Page no. 15 of 108
Approved By:	Dahej LNG Port Terminal	Revision No. : 01 Issue No. : 00 Date: 01 Mar' 2022

	open waters and aid to navigation for these approaches is provided by LUHARA Lt. house and RACONS at Luhara Pt., Piram Island & Gopnath Point.
<b>EQUIPMENTS / PORT HANDLING MACHINERY</b>	<p>Dahej LNG Terminal is equipped with state of art facility of International Standards for berthing / unberthing of LNG Tanker and LNG unloading. Some of the important features of the facilities and its equipments are:</p> <ul style="list-style-type: none"> <li>• <b>TUGS:</b> Four tugs with aggregate bollard pull capacity of 220 tons are available at the terminal for berthing / unberthing of LNG Tankers and to handle any emergency.</li> <li>• <b>FENDERS:</b> LNG Jetty has each 4 Super Cell Fenders one on each Breasting Dolphin.</li> <li>• <b>BERTH AID SYSTEM:</b> Jetties are equipped Laser docking system capable of tracking berthing speed, distance and berthing angle of LNG Tanker being docked. These parameters are displayed digitally on two large display installed on mooring dolphins and are visible from a distance of 300 m from sea.</li> <li>• <b>Quick Release Mooring Hooks (QRMH):</b> QRMH are installed on each dolphin. BDs are equipped with double hook QRMH assembly and MDs are equipped with quadruple hook QRMH assembly. Each QRMH assembly has mooring capstan and each mooring hook has a Load pin incorporated into it for monitoring tension in ship's mooring lines. QRMH can be released locally, manually &amp; remotely.</li> <li>• <b>CT WINCHES:</b> 04 on north and 08 on south hydraulically operated Constant Tension mooring winches are installed on Mooring Dolphins for providing supplementary mooring lines from shore to the ships for additional safety.</li> <li>• <b>MLMS:</b> The Terminal is equipped with Mooring Load Monitoring System (MLMS) and a Carry On Board laptop provided by Terminal to the visiting Tankers for their monitoring mooring line tensions.</li> <li>• <b>UNLOADING ARMS:</b> The jetty is fitted with 3 LNG Unloading Arms and 1 NG Loading Arm with maximum allowed LNG unloading rate of 11,000 m<sup>3</sup>/hr north and 12000 m<sup>3</sup> / hr south. Each arm is</li> </ul>

Section : 01	Oil Spill Contingency Plan	Page no. 16 of 108
Approved By:	Dahej LNG Port Terminal	Revision No. : 00 Issue No. : 00 Date: 21 Nov' 2016

	<p>installed with Quick Connect/Disconnect Coupling (QC/DC). Also each arm is equipped with Powered Emergency Release Coupler (PERC) for quick disconnection during emergency without draining the arms. The arm assembly is installed with Position Monitoring System (PMS) for monitoring the excessive movement (Surge/Sway/Drift) of ship and warning the operator. Also the PMS system is integrated with Emergency Shutdown System (ESD) which is automatically activated when the arms move beyond the permitted range.</p> <ul style="list-style-type: none"> <li>• <b>GANGWAY:</b> Terminal has automatic gangway which has telescopic ladder and self-leveling steps. Gangway has a "freewheel" mode which facilitates it to follow all the movements of the ship automatically.</li> </ul>
<b>TRANSIT SHED &amp; GOWDOWNS</b>	LNG unloaded by LNG Ships is stored in the Shore tanks. There are four (6) LNG storage tanks within plant premises each of 1,48,000 m3 capacity and 1,70,000 m3 for 5 and 6.
<b>WEBSITE</b>	<a href="http://www.petronetlng.in">www.petronetlng.in</a>
<b>CONTACT DETAILS</b>	<p><b>Name :</b> Amit K Ashat  <b>Title :</b> Port Operations Head  <b>Tel :</b> +91 2641 670291, 96625 26288  <b>Email:</b> <a href="mailto:amitashat@petronetlng.in">amitashat@petronetlng.in</a>,  <a href="mailto:shipping@petronetlng.in">shipping@petronetlng.in</a></p>

### C. LOADING / UNLOADING OF LNG AT PETRONET LNG LTD, DAHEJ

Dahej LNG terminal is operating two berth namely north and south berth. This facility handles only LNG and unloading is carried out by unloading arms and then fed to pipelines for storage into shore tanks. Unloading system is identical for both berths. LNG from the ship is pumped into the 6 LNG storage tanks using the ship unloading pumps. The flow can be directed to a single tank or alternatively to any combination of the four storage tanks simultaneously if required. The maximum design filling rate 12750 m3/h and the maximum unloading rates will be limited to 4 250 m3/h per Arm. Three 20"/20" identical arms, each with Powered Emergency Release Coupling (PERC), are provided for carrier unloading at both berths, for LNG transfer to the storage tanks. A fourth 16" arm is provided to route displaced gas back to the ship.

Section : 01	Oil Spill Contingency Plan	Page no. 17 of 108
Approved By:	Dahej LNG Port Terminal	Revision No. : 01 Issue No. : 00 Date: 01 Mar' 2022

LNG is further connected from three unloading arms to two main unloading pipelines on both the LNG berths, these pipelines carry the LNG to storage tanks ashore at about 3.0 to 3.5 bar (g) pressure at maximum unloading rate. The size of the unloading lines at north berth is 30” and on south berth is 32” with about 2.45 km of length.

The unloading pipelines at trestle are designed in such a way that the chances of leakages are almost negligible. The materials used for pipelines is low carbon steel of SS304 grade and there is no flange joint throughout the length on 2.45 km long unloading lines. Further adequate control measures e.g. spill detectors, temperature sensors etc. are in place to detect the leakages, if any, with minimum time delay. LNG as such is unloaded at its boiling point (-160 Deg C), which quickly evaporates into gas form not polluting the marine environment.

Proper risk assessments have been carried out for worst case scenarios and adequate control measures are in place to avoid the leakages and timely detection of leakages, if any.

### **Providing a Safe Workplace**

To achieve the vision of "zero harm" to people, the company has provided appropriate technology with stringent operational control practices across all operations. All operations are required systematically to implement a series of fatality prevention directives. The directives were developed by Holcim after an in-depth analysis of the major causes of fatalities and encompass hazard identification, risk assessment and controls, training, and maintenance and emergency procedures.

The PLL OH&S management system further guides this approach. The health and safety policy has been rolled out across all operations and has been included as a key responsibility in line management and business performance. This policy goes beyond the workplace, to address OH&S issues related to Vehicle and Traffic Safety and home safety issues of our employees and their families. PLL has made significant progress in workplace and personnel safety by focusing on "Safety Observation Process". A systematic reporting system enables the top management to evaluate the overall direction and efficacy of the health and safety system and develop strategies for improving it. To that end, PLL compare their own health and safety results regularly with the goals they have set for themselves.

Regular audits ensure that external and internal regulations/standards are implemented and complied with.

Section : 01	Oil Spill Contingency Plan	Page no. 18 of 108
Approved By:	Dahej LNG Port Terminal	Revision No. : 00 Issue No. : 00 Date: 21 Nov' 2016

## II) BASIS

A Contingency is an event, which happens without any warning and can exploit the existing limited resources of the organization to its stretchable limits. Its timing is uncertain.

This Oil Spill Contingency Plan (OSCP) has been made specifically for M/s. **Dahej LNG Marine Terminal**, At. & Post: Lakhigam, Taluka Vagra, via Dahej, Bharuch: 392 130, Gujarat. It takes care of their range of present activities and short term such as expansion plans. The OSCP is a set of instructions to keep the port ready in response to any contingencies related to oil spill incident/accident in their area of operation. The plan has been made keeping in mind the local weather conditions & other natural parameters. All information and data have been taken from the port's historical records.

Detailed modalities have been developed to effectively respond to any accidental oil spill arising from operational activities at the PLL, Dahej.

### **This Plan is in Three Parts**

#### **PART- I Strategy (What to do & when)**

The first part is designed to help responders understand, in advance, as what is expected of them to minimize pollution of the environment. This section gives details on oil spill scenarios, response objectives & strategies, response organization and details of available response equipment.

#### **PART- II Action and Operations (How to do)**

The second part has specific instruction for responders, on how to do in responding to any oil spill incident near the area of port's operations. This ensures that response action is prompt and orderly.

#### **PART- III Data Directory**

The third part includes all the data necessary to implement the total plan and includes different information. This is arranged for quick reference for responders while taking emergency action.

## **OBJECTIVE**

The primary objective of plan for Oil Spill and preparation of oil spill response and containment plan is to ensure that any spillage of oil along the port & its terminals, in the

Section : 01	Oil Spill Contingency Plan	Page no. 19 of 108
Approved By:	Dahej LNG Port Terminal	Revision No. : 00 Issue No. : 00 Date: 21 Nov' 2016

event of any incident, is immediately responded and contained in a safe and reliable manner with minimal environmental impact & in a professional way to meet recognized National and International standards.

The development of oil-spill containment plan requires consideration of many factors. Geographical elements (location of spill, drainage characteristics, surface conditions, type of soil, type of shoreline, and accessibility of the spill site), environmental elements (weather conditions, surface currents, wave action) and ecological elements (existence and location of areas sensitive because of fish, vegetation, and wildlife) are of major significance. Equally important are oil elements (potential spill volumes, characteristics of the oil, and its behavior in water or on soil) and available equipment and technology (booms, skimmers, absorbents, and surface tension modifiers).

Comprehensive oil-spill containment plan needs to be prepared to ensure that immediate steps are taken to protect the environment, to contain and clean up any spill, and to restore any affected areas. If a spill occurs on land or water, these plans assign immediate what-to-do and how-to-do-it actions to designated individuals.

## **1.1 AUTHORITIES AND RESPONSIBILITIES**

This operational version of Oil Spill Contingency Response Plan for the PLL is intended for use by all such personnel like Tug Masters and all others as indicated in the Spill Response Organization, who may be involved in the response to oil spills which may occur within Dahej Port Limits.

This plan has been prepared as per the stipulation of Ministry of Environment and Forest Clearance (MOEF) and Coast Guard Requirements. It is a strategic plan to quickly call on additional resources in a systematic manner.

While responsibility for oil spill contingency remains with conservator of the port-

Gujarat Maritime Board Port Officer, this plan (Tier 1) demonstrates the readiness of PLL for mitigating oil spill incidents.

Oil spill response is a collective act by all the concerned agencies and the stakeholders. The responsibilities of Designated Agencies in the event of oil spill are enumerated in CG-NOSDCP (Coast Guard's-National oil spill Disaster Contingency Plan) document. This plan is intended to dovetail into Regional Head Quarters plan for response level of Tier 2 and above.

Usually, Director General Coast Guard (DGCG) is the Central Coordinating Authority (CCA) for in preservation, protection and pollution response in zones of India.

Section : 01	Oil Spill Contingency Plan	Page no. 20 of 108
Approved By:	Dahej LNG Port Terminal	Revision No. : 00 Issue No. : 00 Date: 21 Nov' 2016

However, the spills on land, hinterland, should be reported to the District Collector of the affected district keeping OISD, CPCB, MOPNG, MOEF and other state officials including Forest, Fisheries, and State Pollution Control Board etc.

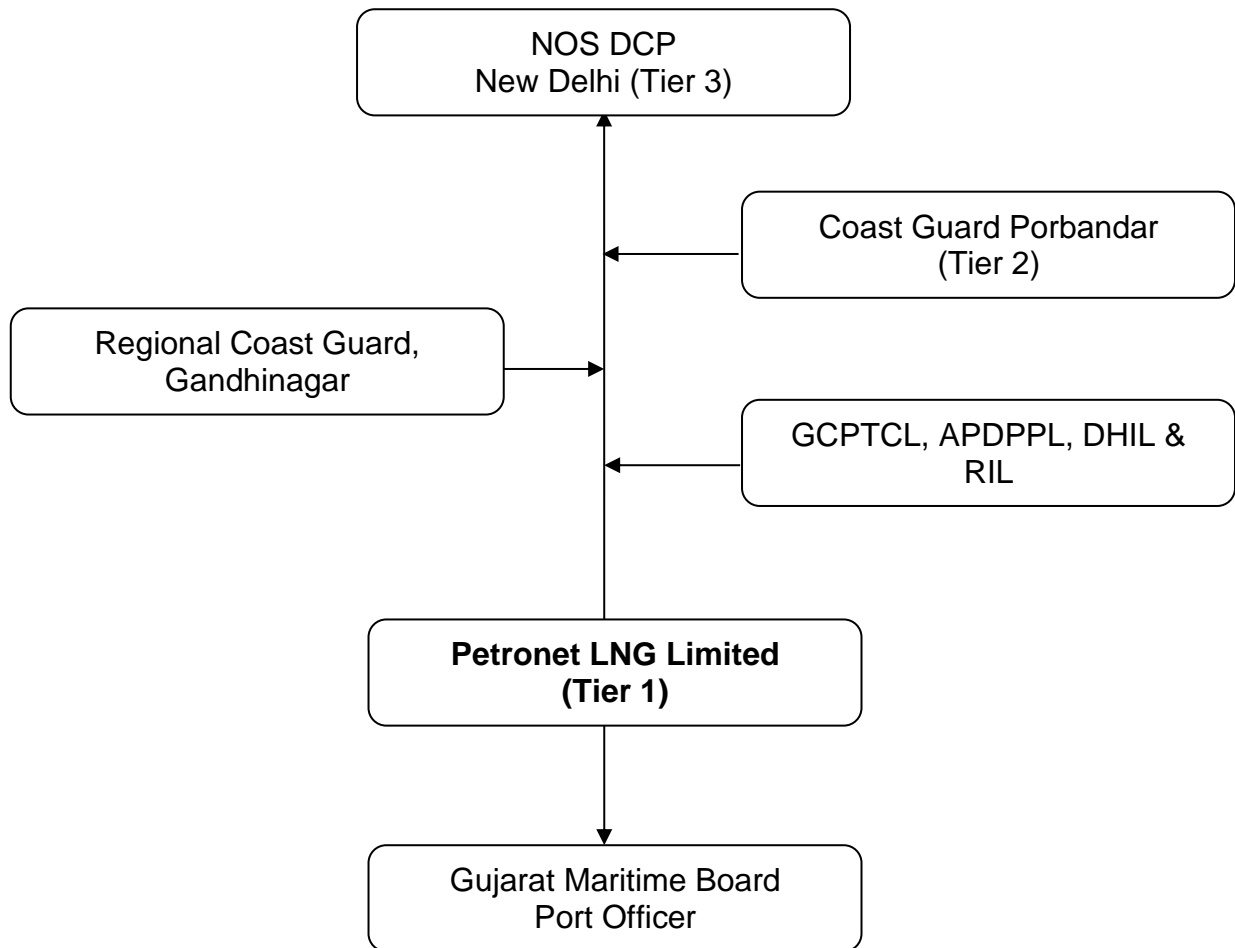

## 1.2 COORDINATING COMMITTEE

The callout system for an oil spill incident is identical to any other emergency. Emergency Control Team (ECT) will arrange mobilization of additional resource like Emergency Response Team (ERT) as and when, required.

### Emergency Control Team (ECT)

The ECT will Comprise of the following members:

- a) Plant Head - Incident Controller (IC)
- b) HOD, Port Operations - On Scene Commander (OSC)
- c) OSR Manager – Vendor
- d) Sr. Manager / Manager
- e) HOD, HSE / Fire Safety

Section : 01	Oil Spill Contingency Plan	Page no. 21 of 108
Approved By:	Dahej LNG Port Terminal	Revision No. : 00 Issue No. : 00 Date: 21 Nov' 2016



- f) Shift Duty Officer
- g) Master of Tug (under Port Manager – Vendor)

### 1.3 STATUTORY REQUIREMENTS

This section summarizes the relevant International and Indian National Laws, which are mentioned below, relating to oil spills that will determine the legal framework in which Oil Spill Contingency Planning and Response Operations must be carried out.

National Laws:

- Merchant Shipping Act, 1958 and its amendment, 2008 and 2010
- Coast Guard Act, 1978
- Environment Protection Act, 1986
- Coastal Regulation Zone Act, 1991
- Water Act 1974

Key International Conventions that bear relevance to oil spill response activities:

- International Convention on Oil Pollution Preparedness, Response and Cooperation (OPRC 1990)
- International Convention for the Prevention of Pollution from Ships 1973 and 1978 Protocol (MARPOL)
- United Nations Convention on Law of The Sea 1982 (UNCLOS)
- International Convention for Safety of Life at Sea (SOLAS)
- Convention of the International Regulations for Prevention of Collision at Sea 1972 (COLREGS)

### 1.4 MUTUAL AID AGREEMENTS

The following Terminals are situated in the nearby area of the port:

- 1) Adani Petronet (Dahej) Port Pvt. Ltd. (APDPPL)
- 2) Gujarat Chemical Port Ltd.(GCPL)
- 3) Dahej Harbour and Infrastructure Ltd. (DHIL)
- 4) Reliance Industries Ltd. (RIL)

A MOU exists among all stake holders mentioned above for extending all support in case of any eventuality.

### 1.5 GEOGRAPHICAL LIMITS OF PLAN

The Port is located at village Lakhigam, 45 km from Bharuch in the Gulf of Khambhat,

Section : 01	Oil Spill Contingency Plan	Page no. 22 of 108
Approved By:	Dahej LNG Port Terminal	Revision No. : 01 Issue No. : 00 Date: 01 Mar' 2022

(along with four other terminals) in Bharuch District of Gujarat State on the West Coast of India.

The Geographical Limits of Plan are given in **Appendix-01**.

This Oil Spill Contingency Plan (Tier 1) is specifically applicable to the bunkering of Harbour tugs at the PLL terminal jetty at the Dahej Port. Oil spill mitigation category of this plan is less than 700 tones.

PLL Petronet (Dahej) Port Pvt. Ltd. falls within the area jurisdiction of Coast Guard Regional Head Quarters (NW Region) located at Gandhinagar, which is also the nearest Coast Guard Station from Dahej.

## **1.6 INTERFACE WITH ROS DCP AND NOS DCP**

The Oil Spill Contingency Plan needs to have an interface with the Regional Oil Spill Disaster Contingency Plan (ROS DCP) prepared by the Regional Head Quarters of Coast Guard Region North West, Gandhinagar, Gujarat and National Oil Spill Disaster Contingency Plan (NOS DCP) promulgated by Coast Guard Headquarters, New Delhi

The present Contingency plan has been made as per the guidelines given by the Indian Coast Guard and hence is fully compatible and ready for interfacing with ROS DCP and NOS DCP.

The chapter scheme of the plan has been taken from 'Guidelines on elements of facility Oil Spill Contingency Plan' annexure to NOSDCP Circular 02/2012 and NOSDCP2015.

Section : 02	Oil Spill Contingency Plan	Page no. 23 of 108
Approved By:	Dahej LNG Port Terminal	Revision No. : 00 Issue No. : 00 Date: 21 Nov' 2016

# **CHAPTER - 2**

## **RISK ASSESSMENT**

Section : 02	Oil Spill Contingency Plan	Page no. 24 of 108
Approved By:	Dahej LNG Port Terminal	Revision No. : 00 Issue No. : 00 Date: 21 Nov' 2016

## 2. RISK ASSESSMENT

One of the most important initial steps in the contingency planning process is the operational risk assessment. This section of the OSCP identifies the oils that will be handled by PLL as a part of this project scope, identification of activities and associated oil spill risks, oil spill modelling results and environmental sensitivities in the region.

### 2.1 IDENTIFICATION OF ACTIVITIES AND RISKS

The probable sources of risk at PLL are given below:

#### 2.1.1 BERTHING INCIDENT (JETTY)

Oil spills can occur as a result of hull contact with the corners of the jetty structure during ship berthing/un-berthing. Such incidents are generally due to failure of a vessel's main propulsion or steering systems, loss of control onboard an attendant tug or pilot error or miss-judgment. The potential spill quantity should hull plating be ruptured in way of an aft wing diesel oil bunker tank can, historically, be up to 100 tonnes.

#### 2.1.2 TUG IMPACT

There are well documented incidents where cargo or bunker oil has been released as a result of hull impact damage by tugs. This can occur when tugs are approaching a vessel underway prior to berthing, or when coming alongside a moored vessel prior to un-berthing. The potential spill quantities again depend on the location and extent of the impact damage but can be over 100 tonnes for bunker oil.

Spills from this cause are considered to be of low likelihood but the risk is acknowledged

#### 2.1.3 COLLISION BETWEEN VESSELS UNDERWAY

Based on the statistical data and its analysis carried out by National Institute of Oceanography, the probability of this type of accident is about one in every eighteen years for the traffic projection. However, the greatest risk of collision relates to vessels transiting the Narmada River channel; an incident of this nature is likely to result in fore part rather than parallel mid-body damage. In the case of severe bow damage, the forward bunker tanks could be breached leading to an accidental release of upto 50-100 tonnes of fuel oil.

Section : 02	Oil Spill Contingency Plan	Page no. 25 of 108
Approved By:	Dahej LNG Port Terminal	Revision No. : 00 Issue No. : 00 Date: 21 Nov' 2016

#### **2.1.4 SHIP GROUNDING**

The depth in the main channel (Narmada Deep Water Channel, Dahej Port), which is partly delineated by light buoys, varies according to the height of tide; the available depth of water is always adequate for LNG vessels trading to Dahej.

While the risk of grounding is low, it cannot be wholly eliminated. The most likely causes are steering or propulsion system failure or navigational error, any of which could result in grounding on the channel margins. Given that the bottom is predominantly soft sand and that all vessels trading to Dahej are double bottomed, the likelihood of any significant hull damage is considered remote. In a worst case scenario, weld fractures in way of the forward bunker tanks could give rise to a release of 10-20 tonnes of fuel oil.

#### **2.1.5 FIRE AND EXPLOSION**

Fires and explosions on board ship represent a safety hazard with the risk of oil pollution as a secondary impact. Fires resulting from uncontrolled smoking in the accommodation, un-authorized hot work such as welding, and engine room fires can spread rapidly if not dealt with swiftly and can give rise to incidents of a very serious nature.

While the likelihood of fire or explosion occurring on board vessels berthed at the jetty is low, the risk is nevertheless acknowledged. Such an incident could give rise to a fuel oil spillage of <700 tonnes.

#### **2.1.6 SPILLAGE FROM PIPELINES**

No oil is transported through the pipe lines. Only the derivatives of oil (Refined Products) which are non-persistent in nature and highly gaseous in nature are transported through the pipelines as given in previous chapter. Hence there is no risk of Oil Spill from pipelines. The spill of the product transported by pipelines are being responded as per the "Local Crisis Group" Off Site Emergency Plan.

#### **2.1.7 SPILLAGES OF FUEL OIL**

Fuel oil bunkers are not supplied to tankers berthed at either jetty. It may, therefore, be necessary for vessels to undertake the internal transfer of fuel oil for trim or other operational reasons. A bunker tank overflow during such operations could result in spillages of <1 tonne.

Section : 02	Oil Spill Contingency Plan	Page no. 26 of 108
Approved By:	Dahej LNG Port Terminal	Revision No. : 00 Issue No. : 00 Date: 21 Nov' 2016

## 2.2 TYPES OF OIL LIKELY TO BE SPILLED

Products handled at PLL Dahej are non-persistent and hence the oil spill response preparedness is not applicable in totality to this port. Most of the gas Tanker are run on LNG hence there is very unlikely chance of oil spill in the area.

However, Diesel oil are used by all other vessels, and hence only Diesel Oil/Bunker oil can be spilled in this port.

### a) Diesel

Diesel is a low viscosity distillate fuel and contains a significant proportion of light-ends. This means that evaporation will be an important process contributing to the reduction in mass balance. The specific gravity of Diesel is typically in the range of 0.802-0.844 (API 35-45), viscosity 4 cst/50°C and pour point -36°C.

Classified as a Group II oil under the ITOPF classification, diesel will spread rapidly on water and should evaporate within a few days after release. Evaporation is enhanced by higher wind speeds, loss in and at higher air and sea temperatures. A small percentage may also dissolve in water. This readiness to evaporate brings about additional concerns regarding explosive risks in the event of an accidental release.

It is to be noted that Diesel after the spill has a time frame of about 24 hours, before it gets vaporized completely.

### b) Furnace Fuel Oil

Fuel oil or heavy oil is a fraction obtained from petroleum distillation, either as a distillate or a residue. Broadly speaking, fuel oil is any liquid fuel that is burned in a furnace or boiler for the generation of heat or used in an engine for the generation of power, except oils having a flash point of approximately 40 °C (104 °F) and oils burned in cotton or wool-wick burners. In this sense, diesel is a type of fuel oil. Fuel oil is made of long hydrocarbon chains, particularly alkanes, cycloalkanes and aromatics. The term fuel oil is also used in a stricter sense to refer only to the heaviest commercial fuel that can be obtained from crude oil, i.e., heavier than gasoline and naphtha.

The boiling point and carbon chain length of the fuel increases with fuel oil number. Viscosity also increases with number, and the heaviest oil has to be heated to get it to flow. Price usually decreases as the fuel number increases.

Number 1 fuel oil is a volatile distillate oil intended for vaporizing pot-type burners. It is

Section : 02	Oil Spill Contingency Plan	Page no. 27 of 108
Approved By:	Dahej LNG Port Terminal	Revision No. : 00 Issue No. : 00 Date: 21 Nov' 2016

the kerosene refinery cut that boils off right after the heavy naphtha cut used for gasoline. Older names include coal oil, stove oil and range oil.

Number 2 fuel oil is a distillate home heating oil. Trucks and some cars use similar diesel fuel with a certain number limit describing the ignition quality of the fuel. Both are typically obtained from the light gas oil cut. Gas oil refers to the original use of this fraction in the late 19th and early 20th centuries - the gas oil cut was used as an enriching agent for carbureted water gas manufacture.

Number 3 fuel oil was distillate oil for burners requiring low-viscosity fuel. ASTM merged this grade into the number 2 specification, and the term has been rarely used since the mid-20th century.

### **2.3 PROBABLE FATE OF SPILLED OIL**

The chances of Diesel or Furnace Fuel Oil (FFO) getting spilled in this port are very low. But even it takes place, it will not be highly disastrous and does not require any major OSR cleanup operations due to 'Low Risk'.

Any oil Diesel oil/ Furnace Oil spill inside the harbor may move towards southwest i.e. open sea side due to the estuary of Narmada River and the current and winds. Since Diesel is volatile, it is likely that spilled oil evaporate quickly from the water surface. Hence diesel oil / Fuel oil spilled in this port will either evaporate within 24 hours. As far as FFO is concerned it may hit the close on shoreline. PLL has signed a MoU with an OSRA, which will be available ready 24 x 7 at Dehaj Port with sufficient equipment and their trained manpower, to combat any oil spill immediately. As per the NOSDCP guidelines PLL Dahej is required to have "CAT'B" Oil spill response capabilities and the OSRA arranged by the PLL is quite capable to combat any oil spill in the area.

### **2.4 DEVELOPMENT OF OIL SPILL SCENARIOS INCL. WORST CASE DISCHARGE**

Keeping all above probable scenario in mind and the prevention measures in place by PLL to reduce the chances of vessel accidents, this OSCP have been made for a worst case discharge scenario of <700 Tonnes of bunkering fuel in case of in case of collision / grounding of the vessel.

### **2.5 SHORELINE SENSITIVITY MAPPING**

No known sensitive areas viz. commercial, recreational, wild life and forests exist in the vicinity of PLL. However, there are mud flats and some vegetation /mangroves patches, which have been marked as sensitive areas on chart no. 2082.

Section : 02	Oil Spill Contingency Plan	Page no. 28 of 108
Approved By:	Dahej LNG Port Terminal	Revision No. : 00 Issue No. : 00 Date: 21 Nov' 2016

The sensitive area map and sensitive map which is available on Coast Guard's website, is given in **Appendix-02**.

This site is an extensive mudflat with an area of about 640 km<sup>2</sup> located at the mouth of the mighty River Narmada in Bharuch District, southern Gujarat. The climate is arid to humid, and there is sparse tropical vegetation. The site was earlier considered an island, and in the course of time it joined the mainland due to excessive sedimentation. A wide span of the mudflats and creek is covered with marshy vegetation, and two species of mangrove are found distributed all around. About five species of marine alga are reported to be found here. Fisheries and cattle rearing are the two main economic activities here. There are a few aqua farms and salt pans in the southern portion, but these are seasonal or non-productive most of the times. Aqua farms and salt pans in the northern part, especially in Dahej, support many poor family of this region. The important minor fishery practice observed here is collection of mudskippers, with many poor local people depending upon it. The marsh and mangrove habitats at an end are naturally protected by mudflats and a network of creeks. There are no potential threats at the site except salt making at a few salt pans and related activities. Fishing takes place along the creeks and mudskipper collection and the activities are limited or restricted only to a certain area. Extensive mudflats with salt marsh vegetation and monospecific mangrove cover are important habitats for feeding wetland birds. The site has been designated a community reserve involving the local fishing community and salt workers.

## **2.6 SHORELINE RESOURCES, PRIORITIES FOR PROTECTION**

The General coastline near PLL port that can be impacted is mud flat at the site; which is biologically moderately sensitive being rich in its nutrient value. There is no classified environmentally sensitive areas exist in the vicinity. The area is thinly populated in small pockets. The thickly populated area of the fishermen is not close to the port entry area. There are no tourists or religious places close to the port. No salt farming or fish farming has also been observed in the near vicinity of Dahej port.

The technique for mud flat type shoreline cleanup is given in **Appendix-03**.

## **2.7 SPECIAL LOCAL CONSIDERATIONS**

Tide at 14 m water depth is generally larger than that at 24 m water depth with an increase of 0.19 m in the mean tidal range. The maximum current speed about 3 m/s with average value of 1 m/s at 24 m water depth and 3.3 m/s with average value of 0.8 m/s at 14 m water depth are noticed. Current direction normally is predominantly between north and northwest during the flood tide and south and southeast during the

Section : 02	Oil Spill Contingency Plan	Page no. 29 of 108
Approved By:	Dahej LNG Port Terminal	Revision No. : 00 Issue No. : 00 Date: 21 Nov' 2016



ebb tide. Alongshore tidal currents are generally lower (average was 0.45 m/s) at 14 m water depth than that at 24 m water depth. Residual cross shore and alongshore current at 14 and 24 m water depth is found to be varying with the corresponding change in the cross shore and alongshore wind.

During the opposing current, wave direction normally turns towards the current direction and almost in alignment with the currents around 180 to 200°. When the waves were following the currents, the waves did not turn to the current direction. When the current is in the wave direction, the wave steepness was found to be decreasing. Peak period found to be high during the following current and mean wave period is generally high during opposing current. The current direction throughout the year is given in **Appendix-04**.

The Jetties are situated inside the harbor toward Gulf of Kambhat. The jetty for the LNG terminal site is on the coast of the Gulf of Khambat, which receives discharges from several major rivers. Water movement in the gulf is influenced by a mixed semidiurnal tide, with a large diurnal inequality and varying amplitude decreasing from north to south along the coast. The sea from the shoreline is shallow up to about 2 km before the sea bed rapidly drops, forming a coastal shelf. At the jetty site, the tidal range averages 8 m. During low tides, the water line recedes from the shoreline as far as about 2 km, which explains the need for a jetty that is 2.5 km long. However, the water depth at the end of the jetty is adequate for the operations of LNG tankers without regular dredging.

Wind and wave conditions in the gulf are favorable for LNG tanker operations. Wind speeds are generally low, though gusty winds are experienced occasionally during the monsoon season. The coastal water is relatively calm most of the time, with waves 0.2–0.5 m in height. Choppy conditions are experienced occasionally in the monsoon season. The unloading operations have established procedures to cope with varying wind and wave conditions.

Section : 02	Oil Spill Contingency Plan	Page no. 30 of 108
Approved By:	Dahej LNG Port Terminal	Revision No. : 00 Issue No. : 00 Date: 21 Nov' 2016

# **CHAPTER - 3**

## **RESPONSE STRATEGY**

Section : 03	Oil Spill Contingency Plan	Page no. 31 of 108
Approved By:	Dahej LNG Port Terminal	Revision No. : 00 Issue No. : 00 Date: 21 Nov' 2016

### 3. RESPONSE STRATEGY

All oil spills are unique events, and each incident will require individual assessment and development of response actions specific to the conditions encountered at the time of the incident. Guidance and recommendations presented in this plan are based on historical experience and evaluation of typical conditions but are not meant to replace case-by-case evaluation, application of alternative or combined response techniques, and use of common sense.

#### 3.1 PHILOSOPHY AND OBJECTIVES

The philosophy of any response is to minimize environmental damage from a spill and mitigate its effects. Usually the response is divided into immediate, mid-term and long-term operations.

The oil spill risk scenario of the port is not found alarming as only Diesel / fuel oil may spill in case of berthing, grounding or collision of vessels. The plan is envisaged for worst scenario for <700T of Diesel / fuel Oil spill.

The objectives of this Plan are;

- a) To conform to PLL's organizational framework with a view to ensure rapid and effective response to any & inland related oil pollution incident
- b) To identify potential sources of as well as hinterland pollution and environmentally sensitive locations in order to establish clear guidelines for the containment, recovery and cleanup of & hinterland pollution with minimal environmental impact
- c) To establish the communication channels essential for the coordination of tasks needed to deal with a pollution incident
- d) To identify specific equipment, materials and personnel necessary to provide an efficient response and to further develop training procedures which will provide essential personnel with the necessary expertise
- e) To ensure that these procedures provide an integrated response together with the NOSDCP

The OSCP of PLL is developed for personnel dealing with oil spills, which may occur by

Section : 03	Oil Spill Contingency Plan	Page no. 32 of 108
Approved By:	Dahej LNG Port Terminal	Revision No. : 00 Issue No. : 00 Date: 21 Nov' 2016

any mean in the port area. Its primary purpose is to facilitate the implementation of the necessary actions to stop or minimize the discharge and to mitigate its effects. The plan has been prepared for oil spills, ranging from local through to international significance, based on the tiered response concept.

In light of the above, no serious environmental damage is expected even if spill takes place view the quantity and the safety measures taken by the PLL. Notwithstanding above, the port have planned to have OSR equipment in place, so that the spill can be responded effectively at all times by containment and recovery. No Dispersant application has been planned for oil spill response due water depth available in the channel and near the jetty is less than 20 meters. However about 100 liters of Dispersant is catered for shore line clean up.

Response Policy:

- Help PLL administration to adopt a system i.e. approach in responding to any oil spill in their area of port operations.
- Provide detailed information to carry out the procedures listed in the plan.
- Provide continuous check and balance related to the efficiency of Oil spill response assets held with them (men and materials) with appropriate training/drill etc.

PLL already have safe operating systems in place to prevent any operational oil spillage, as required by regulatory authorities. It also shares the legal and humanitarian concern for the protection of the natural environment from oil spills. PLL is also committed to implement appropriate contingency plan for spill response and cleanup actions to protect the environment.

To achieve this, policy of PLL is to:

- Have systems in place that will ensure the minimum / no spills.
- Respond immediately to any spill, with the objective of protecting human life, to minimize environmental impacts and to safeguard commercial operations, in this order.
- Consult and Work with appropriate government bodies, Non-Government Organisation (NGO) and the stake holders to address and tackle any issues relating to oil spill in a timely manner.
- Provide adequate /regular awareness training /exercise and information to employees and contractors to let them understand their environmental responsibilities in the prevention and response to oil spill.
- Develop plans and procedures so that incidents (accidental releases) can be responded to in a timely manner.

Section : 03	Oil Spill Contingency Plan	Page no. 33 of 108
Approved By:	Dahej LNG Port Terminal	Revision No. : 00 Issue No. : 00 Date: 21 Nov' 2016

- Develop and maintain management system to identify, control and monitor risks and to comply with statutory regulations and industry guidelines.

Whilst the procedure outlined in this document are to be followed to the maximum possible extent during any oil spill, variation based on sound management / engineering practices and operational experience may be authorized by On Scene Coordinator / On Scene Commander (OSC) nominated by PLL who will be in complete control during any emergency situation.

### 3.1.1 RESPONSE PLANNING POLICIES

PLL considers prevention of accidental oil spills as its first priority and second priority is spill response. To achieve this, policy of PLL will be to:

- Keep systems in place to prevent spill chances.
- Keep Spill response mechanism in place.
- Immediate response to any spill incident.
- Protect human life and to minimize environmental damage.
- Work and consult with appropriate government and NGO bodies.
- Raise awareness among employees and contractors and train them continuously to adapt and adopt to environmental responsibilities.
- Develop emergency plans and procedures so that incidents (accidental releases) can be responded to in a timely manner.

Whilst the system detailed here should be followed as much as possible, variations are allowed as per the discretion of On Scene Coordinator / Commander (OSC) depending upon the site conditions, as all spill scenarios vis-à-vis responses.

### 3.1.2 RESPONSE STAGING AND MOBILISATION

Any emergency response effectiveness is known by its timely response to meet the situation. It is thus imperative that time for the equipment and resources to reach the scene of spill be seen as a critical factor in OSR mobilization of different resources and coordination of number of factors.

Accordingly, the pollution response equipment as per the risk analysis are available on the jetty. Also an MOU has been executed with an OSRA contractor who is available 24x7 for the response operations. For the assistance from other sources and international help the port is well connected. The Nearest railway station is Bharuch and nearest airport is Surat. Both the places well connected with road.

Section : 03	Oil Spill Contingency Plan	Page no. 34 of 108
Approved By:	Dahej LNG Port Terminal	Revision No. : 00 Issue No. : 00 Date: 21 Nov' 2016

### 3.1.3 OIL SPILL CLASSIFICATION OF TIERED RESPONSE

The severity of any oil spill is based on the type and quantity of oil spilled, its distance from the shoreline and the sensitivity of the area where spill has taken place. If a big spill occurs close to coast, the number of outside agencies involved and urgency of their notification increases. Based on the past experience of the oil spills internationally, Tier wise classifications of resources have emerged, as per which PLL will take action as given below:

#### **Tier 1 (Minor Spill - within the Port's capability)**

- Tier 1 is a spill up to 700 tons, which can be responded by the local PLL personnel. The equipment will be procured/arranged by the port or through MOU with other port / company / agency existing nearby.

#### **Tier 2 (Major Spill - Beyond Port's capability)**

- Defined as spills beyond the capacity of PLL and requiring additional resources. Cleanup operations will require spill equipment from PLL stockpiles, response contractors, equipment from local operators, and Indian Coast Guard. Notification of, and support from, the EMT will be required. A planning quantity of 700 – 10000 tonnes may be calculated for Tier 2.

#### **Tier 3 (Crises Event - Beyond National Resources)**

- Tier 3 requires augmenting resources within country and resources from other countries or International support. Such spills are very rare and would only occur through events such as full bore pipe rupture or an uncontrolled tank failure. The spill quantities for Tier3 are > 10000 tonnes.

### 3.1.4 RESPONSE

In any spill Response scenarios, time and weather condition are the most two important factors.

For a response to oil spill, the oil spill response Decision Tree is a useful tool for making the decision. This decision tree and Company specific oil spill response management plan can be used for finding response options. The oil spill response decision tree is given in **Appendix-05**.

Section : 03	Oil Spill Contingency Plan	Page no. 35 of 108
Approved By:	Dahej LNG Port Terminal	Revision No. : 00 Issue No. : 00 Date: 21 Nov' 2016

### 3.2 LIMITING AND ADVERSE CONDITIONS

The oil spill response operation will be very difficult in cyclones and in night time even, if the weather conditions are fair due to visibility and strong wind and current.

### 3.3 OIL SPILL RESPONSE IN OFFSHORE ZONES

The PLL does not carry out any offshore operation. However, have an agreement with consultants/ contractor to provide the equipment with trained manpower to response on any oil spill in the Port / jetty.

### 3.4 OIL SPILL RESPONSE IN COASTAL ZONES

In the case of oil spill reaching the coast line, the endeavour of the PLL will be to deflect it to non-sensitive site, from where it will be cleaned up and disposed as per the GPCB norms and guidelines. The oil spill shall not be allowed to reach the environmentally sensitive areas.

However, sufficient absorbent material like pads and booms will be stored as additional response materials, so that the spill towards shore areas will be responded and recovered as soon as possible.

### 3.5 SHORELINE OIL SPILL RESPONSE

The chance of spilled oil to reach the shoreline is always there, despite best efforts to contain and recover spilled oil. The protection of shoreline areas need to be undertaken having higher economic, environmental and social importance however no such area exists in the operational areas of PLL.

### 3.6 STORAGE AND DISPOSAL OF OIL AND OILY WASTE

The recovered waste spilled oil and water mixture recovered from sea can be stored in barges or temporary storage tanks at Jetty and subsequently can be dispatched for disposal to GPCB's approved recyclers. The storage and disposal details are given in **Appendix-06** and the list of GPCB approved oil /water mixed oil/ sand mixed oil recyclers is also given in **Appendix-07**.

Section : 03	Oil Spill Contingency Plan	Page no. 36 of 108
Approved By:	Dahej LNG Port Terminal	Revision No. : 00 Issue No. : 00 Date: 21 Nov' 2016

# CHAPTER - 4

## EQUIPMENT

Section : 04	Oil Spill Contingency Plan	Page no. 37 of 108
Approved By:	Dahej LNG Port Terminal	Revision No. : 00 Issue No. : 00 Date: 21 Nov' 2016



## 4. EQUIPMENT

For controlling oil spill from spreading and destroying environment/ marine life, recovery of spilled oil is a challenging task which requires expertise, experience and specialized equipment. In this chapter various types of equipment required for containment and recovery of spilled oil, which are considered important for effective contingency plan, have been discussed with a view to identify the source, location and quantity required for such a contingency plan.

### 4.1 MARINE OIL SPILL RESPONSE EQUIPMENT

PLL does not need to maintain major equipment stock pile due to low risk port. Also the vessels visiting PLL terminal are having oil spill response equipment & procedures as per MARPOL 73/78. However to comply with various international and national regulations and to implement them along with the requirement of NOSDCP for category 'B' port, PLL has executed an agreement with a competent vendor with experience, expertise and capabilities to handle response operations for an oil spill up to 700 tons for a fixed period on annual basis.

The vendor hired by port will maintain equipment stockpile in operational manner with trained manpower nearby Jetty or in port premises or on board tug on 24x7 basis. The tugs operated in this port are also maintaining OSR equipment on board as per SOPEP requirement.

The list of Tier-1 OSR equipment is given in **Appendix-08**.

### 4.2 INSPECTION, MAINTENANCE AND TESTING

The Oil Spill Response equipment needs to be maintained in highest state of readiness. This is achieved through a planned maintenance and inspection program.

Since, PLL have hired a contractor, who will provide complete OSR equipment, other materials and trained manpower, OSR team provided by the contractor will maintain all equipment as per OEM laid down procedures in their respective manuals and keep this equipment ready for any emergency.

The HOD, Port Operations will ensure that all oil spill response equipment at PLL is inspected and maintained by contractor as per maintenance schedule or as specified in maintenance schedule of the equipment. The schedule for Training & Maintenance is planned on monthly basis. A record of inspection, maintenance and test is maintained.

Section : 04	Oil Spill Contingency Plan	Page no. 38 of 108
Approved By:	Dahej LNG Port Terminal	Revision No. : 00 Issue No. : 00 Date: 21 Nov' 2016

Similarly, Port Manager (Vendor) will ensure operational readiness of their vessel's spill response capability. This is achieved through regular drills. At least one mock drill in every year is planned.

#### **4.3 SHORELINE EQUIPMENT, SUPPLIES AND SERVICES**

PLL will arrange and maintain all Shoreline clean up equipment / materials as per requirement during emergency.

A list of shoreline clean-up equipment and materials is given in **Appendix-09**.

Section : 04	Oil Spill Contingency Plan	Page no. 39 of 108
Approved By:	Dahej LNG Port Terminal	Revision No. : 00 Issue No. : 00 Date: 21 Nov' 2016

# CHAPTER - 5

## MANAGEMENT

Section : 05	Oil Spill Contingency Plan	Page no. 40 of 108
Approved By:	Dahej LNG Port Terminal	Revision No. : 00 Issue No. : 00 Date: 21 Nov' 2016

## 5.1 CRISIS MANAGER AND FINANCIAL AUTHORITIES

In the event of spill taking place these functions will be carried out by the regular personnel of PLL. The OSC & IC will assess the situation and coordinate to deploy the OSR equipment, oil spill response team and commence the emergency response operations. Subsequently depending upon the situation, more resources (manpower, equipment, boat etc.) could be mobilized through the emergency control Room (ECR). ECR will be managed by Managers of different departments.

The Plant Head of PLL is the final authority of the oil spill response in case of a Tier 1 scenario. He is responsible for raising the level of the response if required and summoning additional help. The authority of all financial decisions is rest with the Plant Head.

## 5.2 INCIDENT ORGANISATION CHART

The Incident organisation chart is given in Appendix-10.

## 5.3 MANPOWER AVAILABILITY (ON-SITE, ON CALL)

The Plant Head of PLL is the final authority of the oil spill response in case of a Tier1 scenario. He is responsible for raising the level of the response if required and summoning additional help. The authority of all financial decisions is rest with the Plant Head.

### Emergency Control Team (ECT)

The ECT will Compromise of the following members:

- a) Plant Head - Incident Controller (IC)
- b) HOD, Port Operations - On Scene Commander (OSC)
- c) OSR Manager – Vendor
- d) Sr. Manager / Manager
- e) HOD, HSE / Fire Safety
- f) Shift Duty Officer
- g) Master of Tug (under Port Manager – Vendor)

Out of this senior team, responsibilities will be divided to those personnel, who will collectively control and manage the oil spill response operations. Only those duties

Section : 05	Oil Spill Contingency Plan	Page no. 410 of 108
Approved By:	Dahej LNG Port Terminal	Revision No. : 00 Issue No. : 00 Date: 21 Nov' 2016

specified to oil spill are listed, which will be in addition to their normal duties. Their duties must be observed in conjunction with the general emergencies duties.

The callout system for an oil spill incident is identical to any other emergency. Emergency Control Team (ECT) will arrange mobilization of additional resource like Emergency Response Team (ERT) as and when, required.

#### **5.4 AVAILABILITY OF ADDITIONAL MANPOWER**

Any requirement of additional manpower will be met by HR Department, who will be maintaining a list of trained manpower available with various departments and also casual workers who can be utilized ashore for shore cleanup operations or as deemed fit. It is pertinent to mention here, that while utilizing such people for this type of job it would be better to scrutinize / screen such people of their suitability for skilled and unskilled work well before hand. Preferably this work is to be under taken during Mock Drills so as to ensure availability of a dependable additional work force apart from the designated workforce.

#### **5.5 ADVISORS AND CONSULTANTS - SPILL RESPONSE, WILDLIFE AND MARINE ENVIRONMENT**

The nearby Coast Guard Unit, CG DHQ Porbandar, GG RHQ, (NE) and Coast Guard Pollution Response Team (W), Gujarat Pollution Control Board, District Collector & District Magistrate can be sought for advice as felt necessary. The nearest authorities of PLL, i.e. Gujarat Chemical, Birla Copper, Adani Pertronet and Reliance etc. will also consulted and mobilise responses from National /International experts, if required. A list of Advisors and Consultants is given in **Appendix-11**.

#### **5.6 TRAINING / SAFETY SCHEDULES AND DRILLS / EXERCISE PROGRAMME**

##### **5.6.1 TRAINING**

Training of all PLL staff, who may get involved in implementing this plan is acknowledged. Since emergencies are not frequent, the equipment and men needed to respond to the emergency tend to become slack in their operation, if regular training is a not a part of the system. PLL personnel are trained in different aspects of oil spill response operation, appropriate to their role/ responsibilities in emergency management. In house and external facilities like Coast Guard will also used periodically to impart training as per matrix.

Section : 05	Oil Spill Contingency Plan	Page no. 42 of 108
Approved By:	Dahej LNG Port Terminal	Revision No. : 00 Issue No. : 00 Date: 21 Nov' 2016

The HOD, Port Operations, PLL in consultation with the Plant Head as training coordinator and custodian of oil pollution equipment, will ensure that the emergency response team personnel, who are required to operate oil spill equipment, undergo training for effective deployment of equipment and devices.

Masters of PLL's all vessels and Tugs are to ensure that their crew is fully trained in deployment of equipment and devices held on board.

The schedule of Training and competency is given in **Appendix-12**.

### **Drills and Exercise**

Drills serve to evaluate the thoroughness and effectiveness of the emergency response component of the PLL Oil Spill Response Plan by testing under simulated conditions.

The HOD-Port Operations of PLL will organize drills or exercise and inspection of equipment as per the plan in force and to have the maximum utilization of equipment in each exercise. Six monthly exercises are proposed for testing OSCP. These will also provide management an opportunity to assess equipment, measure performance and obtain feedback from participant, update and correct the OSCP and give input for continued commitment of the company to oil spill prevention and response.

Drills and Exercise involve any or a combination of the following:

- Oil Spill contingency plan orientation
- Table Top Scenarios for ERT and mock up exercises activating oil spill response.
- Equipment and personnel mobilization and deployment
- Joint exercise with other organization / ports
- Full scale incident management exercise.

A debrief will be done by the OSC to identify weakness in the plan and equipment, and undertake remedial action within a prescribed time. The HOD-Port operation, PLL is responsible for keeping the OSCP up to date.

### **5.6.2 SAFETY**

In order to minimize the potential hazards of the spilled oil and the environment in which the incident response team may be operating in, a number of steps must be taken in order to protect the response team. It is essential that a safe working environment be established before commencing spill control, cleanup and / or repair operations.

Section : 05	Oil Spill Contingency Plan	Page no. 43 of 108
Approved By:	Dahej LNG Port Terminal	Revision No. : 00 Issue No. : 00 Date: 21 Nov' 2016

Each spill response shall follow standard health and safety procedures, in order to protect the health and safety of those responding and the non-response personnel who may be in the vicinity and, if applicable, the general public.

A risk assessment is required as part of the Health and Safety Planning process. It must be carried out prior to undertaking any response task (irrespective of Tier size) and shall define the possible hazards likely to be encountered. All personnel involved must be fully aware of the hazards and the procedures for reducing or eliminating, where possible, the impact of the hazard before performing any task. This assessment includes characterization of both on-site and potentially, impacted off-site areas. Information collected will be used to determine the following:

- Need for evacuation of threatened areas;
- Establishment of clearly marked safety zones and restricted areas;
- Procedures to be followed by response personnel in the different zones;
- Decontamination procedures.

The Occupational Safety and Health Act require that employers provide a safe and healthful workplace free of recognized hazards and follow OSHA standards. Employers must also provide training and required protective equipment. Workers must follow the employer’s safety and health rules that comply with OSHA standards and wear or use all required gear and equipment.

**A) GENERAL SAFETY AND HEALTH RULES**

1. All work-related injuries/illnesses or vehicle collision, no matter how slight, shall be reported immediately to Medical officer through supervisor.
2. All fires, spills, and releases, no matter how small, shall be reported immediately to your supervisor.
3. Immediately report any unsafe condition, practices, near miss or incident to your supervisor.
4. All personnel shall wear seatbelt while in Company vehicles, including rental car and personal cars utilized on business travel.
5. Possession, use, distribution or being under the influence of prohibited drugs or unauthorized alcohol while on the job or company property is prohibited.
6. The use or possession of firearms, deadly weapons or unauthorized explosives on Company property is prohibited.
7. No unauthorized work may be carried out in any area or on any equipment without consent of the respective person-in-charge (PIC).

Section : 05	Oil Spill Contingency Plan	Page no. 44 of 108
Approved By:	Dahej LNG Port Terminal	Revision No. : 00 Issue No. : 00 Date: 21 Nov' 2016

8. Operation of equipment having a “DANGER, DO NOT OPERATE” tag is prohibited.
9. Under normal operation, all operating machinery and electrical switchgear must have all safety guard, switches and alarm in place and be functional.
10. Finger rings, wristwatches, and other jewelry, along with loose clothing, unsecured long hair and other loose accessories shall not be worn when within arm’s reach of unguarded operating machinery or electrical switchgear.
11. Do not apply compressed air to yourself or others.
12. When ascending or descending stairways, use the handrail and take one step at time.
13. Running in work areas, except for emergency purpose, is prohibited.
14. Use only proper tools and equipment maintained in good working condition.
15. Ladders, work platforms, scaffolding, personal lifts or fall protection must be used when working at heights greater than 6 ft (1.8m) when the potential for falling exists.
16. Fire extinguisher and all other emergency equipment must be in good condition, inspected regularly and kept clear of any obstruction.
17. Use proper lifting techniques such as bending of the knees, obtaining assistance, or mechanical lifting loads.
18. Approved hard hats shall be worn in field operations and other designated areas.
19. Approved foot protection is required in field operations and other designated areas.
20. Approved safety eyewear shall be worn in field operations and other designated areas.
21. Eye/face protection such as goggles and a face shield shall be worn during grinding, welding, drilling, scraping or any operation where foreign objects may enter the eye.
22. Personnel handling chemicals or other agents shall wear proper eye or face protection and other PPE as recommended by the MSDS.
23. Hearing protection shall be worn in high noise areas (85dB or higher).
24. Personnel shall wear proper hand protection when performing tasks that may present injury to hands.

## **B) HAZARDOUS CHEMICALS AND MATERIALS**

### **Basic rules and procedures for working with chemicals**

- In case of eye contact, promptly flush eyes with clean fresh water for a prolonged period (15 to 30 Minutes)
- In case of skin contact, promptly flush the affected area with water (15 Minutes), remove contaminated clothing and seek medical attention.
- Do not smell or taste chemicals.

Section : 05	Oil Spill Contingency Plan	Page no. 45 of 108
Approved By:	Dahej LNG Port Terminal	Revision No. : 00 Issue No. : 00 Date: 21 Nov' 2016



- Do not eat, drink, smoke, chew gum or apply cosmetics in areas where hazardous chemicals are in use. Wash hands before conducting these activities.
- Chemical and equipment shall be properly labeled and stored.
- Assure that all persons, including visitors, wear appropriate eye protection where chemicals are stored or handled.
- Wear appropriate gloves when the potential for contact with hazardous materials exists, inspect the gloves before each use, wash them before removal and replace them periodically.
- A material safety Data sheet (MSDS) for each chemical shall be readily available.
- No hazardous chemical shall be accepted without appropriate labeling and MSDS.
- Toxic substances shall be segregated in a well-identified area with local exhaust ventilation.
- Stored chemical shall be examined periodically for container integrity.

Section : 05	Oil Spill Contingency Plan	Page no. 46 of 108
Approved By:	Dahej LNG Port Terminal	Revision No. : 00 Issue No. : 00 Date: 21 Nov' 2016

# CHAPTER - 6

## COMMUNICATIONS

Section : 06	Oil Spill Contingency Plan	Page no. 47 of 108
Approved By:	Dahej LNG Port Terminal	Revision No. : 00 Issue No. : 00 Date: 21 Nov' 2016

## 6.1 INCIDENT CONTROL ROOM AND FACILITIES

A separate room has been earmarked as ECR near port site at PLL and this place designated for the Emergency Control Team (ECT) to assemble and operate from there. The whole OSR operations are observed reviewed and directed from this room only. Necessary chart, books, reference material, telephone number, etc. and other facilities / item as required would be available at ECR. The various facilities shall require being present in this room are as follows:

- Conference table & chairs to accommodate at least 10-12 senior officers.
- A White Board with suitable writing facilities.
- A Computer with Printer and Power Point presentation system.
- A Telephone with Fax and STD/ISD facilities.
- VHF Walkie Talkie communication facilities with OSC & Oil Spill Response Team

## 6.2 FIELD COMMUNICATIONS EQUIPMENT

An effective inter facility communication system among various agencies / teams / ship etc. associated with oil spill response is considered a must. However a sufficient number of VHF sets are positioned with port officials / communication center for use, whenever required.

PLL has developed an emergency response communications system to link its command centers with field operations. This system utilizes mobile telephones and VHF radio. Tactical communications is the responsibility of the Emergency Response Team Leader and the IT Manager. A communication center will be set up, if required, at the site of the spill depending on the size and severity of the event. For a large incident, a satellite communications center may be established. The features of the PLL Communications Network include:

- **Radio Room:** The location and telephone number(s) of the Radio Room will be assigned at the time of the incident. While the Radio Room is primary function will be operational communications, it can be set-up to accept and refer incoming media and public relations calls to the appropriate section for processing.
- **Mobile Phones:** PLL personnel who assigned to media/public relations duties during an incident will be issued mobile phones. The main form of communication from vehicles and staff in the field will be by mobile phones.
- **Press Room with Telephones:** If the incident is of sufficient magnitude /

Section : 06	Oil Spill Contingency Plan	Page no. 48 of 108
Approved By:	Dahej LNG Port Terminal	Revision No. : 00 Issue No. : 00 Date: 21 Nov' 2016

sensitivity, a pressroom will be established. The pressroom will have access to temporary telephone lines.

- **Terrestrial or Landline Telephones:** Office staff working on the incident will utilize the terrestrial telephone networks currently in place.
- **Commercial Providers:** There are several communications service providers and associated networks in India.
- **VHF:** Every vehicle will be equipped with a handheld VHF radio.
- **Aircraft (ground to air):** Where necessary oil spill crew members will be supplied with a VHF radio, which will have appropriate air-band frequencies enabled, for communication with helicopters etc. used in the incident.

The PLL has the following Navigation and communication equipments:

- Walkie Talkie – 04
- VHF Sets – 2

### 6.3 REPORTS, MANUALS, MAPS, CHARTS AND INCIDENT LOGS

From Oil Spill Report Form it is to be ensured that the basic information required to formulate a response strategy to an Oil Spill Emergency is obtained. OSC will complete the forms and dispatch to the concerned authorities by the fastest means. In all cases, the original report forms to be handed over to HOD-HSE Fire Safety to maintain record of all such documents. The format for Oil Spill Report Forms including status report Format and POLREP format are given in **Appendix-13**.

The personnel log form (with continuation sheets) allows all personnel involved on the emergency response to maintain a personal log of event. The personal log forms with continuation sheets are to be used during the oil spill response to record the contacts and activities carried out during the emergency. After the “stand-down” of operation, the personal log form with continuation sheet will be numbered, signed and to be handed over to the HOD-HSE. The format of personal log form is given in **Appendix-14**.

Section : 06	Oil Spill Contingency Plan	Page no. 49 of 108
Approved By:	Dahej LNG Port Terminal	Revision No. : 00 Issue No. : 00 Date: 21 Nov' 2016

**PART – II**

**ACTION AND OPERATIONS**

**CHAPTER - 7**

**INITIAL PROCEDURES**

Section : 07	Oil Spill Contingency Plan	Page no. 50 of 108
Approved By:	Dahej LNG Port Terminal	Revision No. : 00 Issue No. : 00 Date: 21 Nov' 2016

## 7. INITIAL PROCEDURES

The first few minutes after the incident / accident are invariably the most critical period in prevention of escalation. The emergency actions (due to spill) should be initiated by the first person noticing it by activating the fire alarm from the nearest call-point or by contacting the Control Room immediately on the internal telephone or through mobile phone or through VHF Channel.

The OSC, designated from the PLL, after informing the concerned agencies should consider the following factors for ensuring proper response & containment of oil spill scenario on land.

- a) Assess the Situation
- b) Activate the Contingency Plan
- c) Activate the Organizational Response
- d) Prepare the Response Action Plan
- e) Activate the Operational Response
- f) Manage the Ongoing Response
- g) Deactivate the Response
- h) Keep Records & consolidate the costs
- i) Debrief & Report

### 7.1 NOTIFICATION OF OIL SPILL TO CONCERNED AUTHORITIES

The Duty Officer / Radio Room/ Shift in-charge is to inform HOD - Port Operations of the incident, who in turn is to inform Plant Head / HOD HSE/ fire Safety, ERT/ECT.

OSC and IC are to follow the procedure outlined in this document to the greatest extent possible. However they are permitted to take action in variance with this document subject to prevailing conditions with proper information to ECT.

Statutory First Information Report (FIR) is to be communicated by fastest means possible to President GMB port and CGRHQ (NW) at Gandhinagar, followed by full Pollution Report (POLREP). The report is to be updated, should the oil spill not be contained and likely to increase to Tier 2.

### 7.2 PRELIMINARY ESTIMATE OF RESPONSE TIER

Every oil spill sighted at the shoreline or at sea adjoining the coastline of Gujarat are to be reported immediately to the Coast Guard, State Environment Ministry, concerned

Section : 07	Oil Spill Contingency Plan	Page no. 51 of 108
Approved By:	Dahej LNG Port Terminal	Revision No. : 00 Issue No. : 00 Date: 21 Nov' 2016

District collector, State Maritime Board and State Pollution Control Board by telephone or fax. The appropriate agency which is located nearby to the site of the oil spill shall proceed to investigate after obtaining the sighting report from the public.

The appropriate agency in most cases will be the District Collector who will thereafter make the Pollution Report (POLREP) in accordance to the format in **Appendix-13** to Coast Guard, State Environment Ministry and to every other concerned agency. The primary information that should be reflected in the POLREP is:

- a) Quantity and quality of oil spill that is onshore and on water
- b) Source of the oil spill
- c) Any resources, flora and fauna that are affected in the area

### **7.3 NOTIFYING KEY TEAM MEMBERS AND AUTHORITIES**

The OSC is to inform IC of the incident who in turn is to inform all the concerned members and the authorities as per the existing Information System prevailing. Communication channel is given in **Appendix-15**.

### **7.4 MANNING CONTROL ROOM**

Depending upon the severity of the spill, IC will decide whether he will handle it alone or would need to activate the ECT. If needed, an Emergency Control Team (ECT) would be set up comprising of people, as given below:

An ECT would be set up comprising of:

- a) Plant Head - Incident Controller (IC)
- b) HOD, Port Operations - On Scene Commander (OSC)
- c) OSR Manager – Vendor
- d) Sr. Manager / Manager
- e) HOD, HSE / Fire Safety
- f) Shift Duty Officer
- g) Master of Tug (under Port Manager – Vendor)

The IC shall be required to coordinate with members of the ECT.

### **7.5 COLLECTING INFORMATION (OIL TYPE, SEA / WIND FORECAST, AERIAL SURVEILLANCE, BEACH REPORTS)**

HOD, Port Operations or OSC has the responsibility of arranging the collection of the

Section : 07	Oil Spill Contingency Plan	Page no. 52 of 108
Approved By:	Dahej LNG Port Terminal	Revision No. : 00 Issue No. : 00 Date: 21 Nov' 2016

relevant information which will help in mitigating the emergency. The OSC is to collect the following information immediately in case of oil spill:

- a) Time spill occurred
- b) Position in Latitude/ Longitude and also with reference to any prominent land mark
- c) Visual appearance, apparent thickness of oil and extent of area covered
- d) Percentage cover of various thickness of oil
- e) Existing weather condition and weather forecast
- f) Current, tide and wind conditions
- g) Immediate availability of support vessels, equipment and man power specifying time factor as well
- h) Estimate oil spill trajectory and likely area and time of its landfall

## 7.6 ESTIMATING FATE OF OIL SLICK (24, 48 AND 72 HOURS)

Considering the prevalent tidal stream, wind and weather conditions, and section 2.3 is to be used in estimating the fate of the slick. Also on the basis of data gathered, the oil spill tracking can be carried out, either manually or by software, if available; and placed for the perusal of ECT by OSC.

## 7.7 IDENTIFYING RESOURCES IMMEDIATELY AT RISK, INFORMING PARTIES

Depending on the quantity of spilled oil and the prevalent wind & weather conditions, the resources / facilities immediately at risk have to be identified by the On Scene commander and the concerned parties i.e. local port authorities, coast guard and other authorities/ agencies as applicable are to be informed. The Telephone details of these authorities are given in **Appendix-16**.

Section : 07	Oil Spill Contingency Plan	Page no. 53 of 108
Approved By:	Dahej LNG Port Terminal	Revision No. : 00 Issue No. : 00 Date: 21 Nov' 2016



# CHAPTER - 8

## OPERATIONS PLANNING

Section : 08	Oil Spill Contingency Plan	Page no. 54 of 108
Approved By:	Dahej LNG Port Terminal	Revision No. : 00 Issue No. : 00 Date: 21 Nov' 2016

## 8.1 ASSEMBLING FULL RESPONSE TEAM

OSC, in consultation with ERT personnel shall assemble and conduct thorough briefing about their role and responsibilities. The Emergency Response Team (ERT) would consist of personnel from Port Operations or security department. It is planned to have an afloat Oil Spill Response Team with four members.

The shore ERT would also consist of two groups. This would be mostly drawn from Security or Fireman personnel and workers. These teams would be led by at least one experienced personnel each. Formation of both Afloat and Ashore OSRTs are given in **Appendix-17.**

The pollution response equipment are to be kept onboard tug for deployment. The captain of the tug is to assist the OSC with the conduct of the oil spill response activities from his tug. The vessel shall remain in direct communication with ECR.

### ROLES AND RESPONSIBILITIES

#### A) Plant Head - Incident Controller (IC)

- Start personal log of events
- Assess the seriousness of the incident, upon receipt of the information mobilise ERT at ECR if required Inform

As circumstance require:

- Call OSR Team personnel as per duty roster
- Proceed to jetty Control Room / Emergency Control Room
- Confer with the OSC Commander and determine the most effective method of dealing with the spill.
- Commence slick movement tracking operation
- Ensure appointment of an On Scene Observer and mobilization of vessel / craft with suitable equipment.
- Mobilize shore cleanup team if required.
- Seek help from state administrative for shore cleanup as required
- Consider the use of external technical assistance if the emergency is major (e.g. Vessel rupture etc.)
- Consider requesting help from other ports
- Initiate Mutual Aid Assistance Scheme if such pact exists between different organizations (i.e. ports, oil companies, etc.)
- Consider requesting Coast Guard to take over the situation under NOS – DCP

Section : 08	Oil Spill Contingency Plan	Page no. 55 of 108
Approved By:	Dahej LNG Port Terminal	Revision No. : 00 Issue No. : 00 Date: 21 Nov' 2016

- Consider requesting Private agencies (national) in this field for assistance / contract for cleanup.

General:

- Maintain close liaison with the following as appropriate
  - OSC
  - Oil Spill Response Team
  - Prime Contractor (i.e. Boat, Tug, Man power, Transport etc.)
  - Government Agencies (Coast Guard, Administrative etc.)
  - Plant Head
- Ensure surveillance continues until oil slick considered no longer hazardous
- Ensure detailed recording of log of events carried out
- Both safety & security of men is above the material is to be kept in the mind always.

Initial action in the event of spill

- Receive brief from observer of spill.
- Assess the situation & take appropriate steps to
  - Establish the source of leak /spill
  - Reduce / prevent further leak / spill
  - Deal with spill.
- Post a spill observer who will continuously monitor the direction of oil spread
- Muster the Oil Spill Response Team and mobilize them to handle OSR equipment. Raise alarm and stop the operation as necessary.
- Inform immediately to the HOD, Port Operations, who will immediately assume the role of OSC.
- Initiate initial pollution report as per format.
- Handle any associated emergency with wider implication in accordance with the disaster management plan of the terminal.
- If the leak / spill is continuing & large, assess the
  - Risk to life and the port installation
  - Size and consequences of the spill
  - Ability of the organization to handle the spill
- Request support from external resource
- Instruct the designated tug / vessel to act in consultation with OSC

**B) HOD, Port Operations - On Scene Commander (OSC)**

- Assume overall charge of situation and leader of ECT
- Proceed to Emergency Control Room (ECR)

Section : 08	Oil Spill Contingency Plan	Page no. 56 of 108
Approved By:	Dahej LNG Port Terminal	Revision No. : 00 Issue No. : 00 Date: 21 Nov' 2016

- Evaluate the state of situation.
- Ensure other protocol and regulatory requirement are taken care of
- Inform media coordinator
- Consider the use of external technical assistance if the emergency is major (e.g. Vessel grounding/rupture etc.)

**Immediate:**

- Start personal log of events
- Establish the following information:
  - Time of spill occurred
  - Weather condition and sea state.
- Investigate the source of leak / spillage
- Co-ordinate with other ECT members in drawing a strategy and dealing with the situation.
- Contact the tugs/boats and request response to spill
- Inform higher authorities.

**As circumstances require:**

- Determine whether the incident can be handled by resource available or will require activation of ERT.
- Instruct a boat to take sample of spilled oil, if possible, for analysis and evaluation.
- Utilise the boat to monitor the spillage of oil by giving suitable instruction / directions.
- Request Coast Guard to take over the situation under NOS – DCP, if it seems beyond control.
- Consider requesting help from other nearby organisations
- Initiate Mutual Aid Assistance Scheme, if such pact exists between different organizations
- Seek help from state administrative for shore cleanup as required.
- Maintain close liaison with Government Agencies (Coast Guard, Administration. Etc.)

**C) OSR Manager – Vendor**

- Evaluate the state of situation.
- Depending upon the spill size, arrange mobilization of vessel / craft with suitable equipment.

Section : 08	Oil Spill Contingency Plan	Page no. 57 of 108
Approved By:	Dahej LNG Port Terminal	Revision No. : 00 Issue No. : 00 Date: 21 Nov' 2016

Immediate:

- Establish the following information:
  - Position and shape of spill / slick
  - Visual appearance and apparent thickness of oil
  - Percentage cover of the various thickness of oil
  - Speed and direction of oil slick
- Co-ordinate with other ECT members in drawing a strategy and dealing with the situation.
- Contact the tugs/boats and request response to spill

As circumstances require:

- Work with the other ECT members to reduce or prevent further oil spill without compromising on safety.
- Initiate loading/unloading/operational shut down depending on the condition / situation.
- Consider requesting help from other nearby organisations.

**D) Sr. Manager / Manager**

Immediate:

- Receive brief from OSC
- Ensure Operation Room (Communication center) manned round the clock
- All communication equipment, telephone/cell phone, VHF equipment etc. are operational.
- Stand by VHF equipment are to be issued to the ECT and ERT Team Leaders.
- Monitor all the VHF and telephone conversation.
- Log of events to be maintained.

General:

- Keep a detailed log of events
- Personnel not connected with the operation / OSR work are not to be permitted at the site of spill
- Security system is to be strengthened and briefed about the requirement / operation

**E) HOD, HSE / Fire Safety**

Immediate:

- Start personal log of events
- Receive brief from OSC

Section : 08	Oil Spill Contingency Plan	Page no. 58 of 108
Approved By:	Dahej LNG Port Terminal	Revision No. : 00 Issue No. : 00 Date: 21 Nov' 2016

- Mobilize all manpower of the dept. on duty
- Advise OSC any danger to the mechanical equipment from oil spill.
- Breakdown maintenance team to be briefed about the incident
- Breakdown maintenance teams be told to be available at all times to attend defects / assist ERT as and when required.
- Ensure and confirm all mobile units, cranes, forklifts, tankers, etc. are operational.
- Establish contact on VHF / telephone with all ECT members.

As circumstance require:

- Provide lighting arrangement at the worksite
- Portable petrol /diesel driven gensets to be made available on crafts on required basis.
- Check all fire equipment about their service ability and reach ability.

General:

- Assist / Advise ERT in all technical matters
- Advise safe working parameters of the technical equipment to the ERT /OSR team personnel.
- Advise ERT/ OSR Team

#### **F) Shift Duty Officer**

- Start personal log of events
- Assess the seriousness of the incident, upon receipt of the information, mobilise ECT at ECR, if required
- Brief skipper/ operator of the boat, drivers of the vehicles etc. on requirement
- Establish Contact with all own departmental personnel and direct them of requirement arising.
- Advise OSC on logistics matters which are likely to be affected by oil spill
- Advise appropriate precautionary method to be adopted for the shore cleanup.

As circumstances require:

- Call ERT personnel as per duty roster
- Proceed to jetty / Emergency Control Room
- Contact OSC and determine the most effective method to deal with the spill.
- Commence slick movement tracking operation
- Inspect the shoreline structure affected/likely to be affected by oil spill/slick Ensure equipment likely to be used for shore cleanup are kept ready for use (i.e. pick axe, shovels, empty gunny bags etc.)
- Availability of such equipment is to be suitably listed.

Section : 08	Oil Spill Contingency Plan	Page no. 59 of 108
Approved By:	Dahej LNG Port Terminal	Revision No. : 00 Issue No. : 00 Date: 21 Nov' 2016

General:

- Maintain close liaison with the following as appropriate
  - OSC
  - Prime Contractors (i.e. Boat, Tug, Man power, Transport etc.)
- Ensure surveillance continues until oil slick considered no longer hazardous.
- Ensure detailed recording of log of events carried out.
- Mobilise cleanup team and equipment as advised by ECT
- Arrange for Tug to be equipped with any required equipments
- Arrange necessary boarding/lodging arrangement for any party/personnel arriving from outside in connection with oil spill incident
- Liaise with OSC and ERT on resources availability and progress of cleanup operations

The fact that “Both safety & security of men is above the material” is to be kept in the mind all the time.

- Receive brief from person, who first noticed the oil spill.
- Assess the situation & take appropriate steps to
  - Establish the source of leak /spill
  - Reduce / prevent further leak / spill
  - Deal with spill.
- Post an oil spill observer, who will continuously monitor the direction of oil spread
- Muster the ERT and mobilize them to handle OSR equipment. Raise alarm and stop the operation as necessary.
- Report immediately to the OSC
- Initiate initial pollution report to everybody concerned, including Coast Guard as per NOS DCP guidelines.
- Handle any associated emergency with wider implication in accordance with Terminal’s disaster management plan.

**G) Master of Tug (under Port Manager – Vendor)**

Action in the event of being notified of an oil spill:

- Monitor the spillage and keep the OSC informed of the situation.
- Load & activate OSR equipment and ERT and coordinate with them to deploy OSR equipment, as required
- Depute personnel to assist ERT
- Coordinate with OSC and Master/Skipper of other vessels for the deployment of equipment for containment and recovery of oil etc.

Section : 08	Oil Spill Contingency Plan	Page no. 60 of 108
Approved By:	Dahej LNG Port Terminal	Revision No. : 00 Issue No. : 00 Date: 21 Nov' 2016

- Establish the following information
  - Position and Shape of spill / slick
  - Visual appearance (thickness) of the oil
  - % cover of the various thickness of oil
  - Speed and direction of spill / slick
  - Update status to OSC / Technical head
  - Coordinate activities with any other support vessel/ craft available in the area
  - Ensure other vessel / craft (e.g. local fishing boat, or craft etc) do not move into the area under concern
  - Record and update local weather condition to OSC

## 8.2 IDENTIFYING IMMEDIATE RESPONSE PRIORITIES

IC and ERT, with the help of initial estimated response tier or oil slick movement simulation data and prevailing weather condition, will identify the immediate resources at risk and the response priorities.

The immediate response priorities in the order of sequence are

- Contain the oil spill.
- Start recovery action.
- Ascertain where the spill is likely to head on and then inform the Head of the Panchayat /Village /Commercial organization people.
- Take action for containment or cleanup measures of the oil spill, for example by use of Sorbent pads, Sorbent booms or Shore sealing booms etc.
- Ascertain quantity of oil spilled so as to arrive to a conclusion of establishing response strategy.
- Inform Coast Guard / Commissioner of Ports / GPCB, authorities the nature of spill and action taken.
- Inform district authorities i.e. District Collector & District Magistrate etc. about nature of spill and action taken.
- Inform nearest Government Hospital or Specialists doctors if chances of any casualties are anticipated.

## 8.3 MOBILISING IMMEDIATE RESPONSE

The OSR equipment for both offshore and onshore have already been arranged from vendor keeping in mind a Tier-I response. Vendor will operate these equipment keeping existing weather conditions in mind. For adverse weather conditions as elaborated

Section : 08	Oil Spill Contingency Plan	Page no. 61 of 108
Approved By:	Dahej LNG Port Terminal	Revision No. : 00 Issue No. : 00 Date: 21 Nov' 2016



above no response would be effective, however shoreline protection will be done. During normal weather conditions, booms are to be laid out in directions so as to help the current in bringing the spilled oil to the V of the boom. However, it will be ensured that if the booms are not to be towed at the speed of more than 1 knot, as then the oil will escape below the boom. The deployment plan of boom shall necessarily require good seaman practices. Emergency response team, masters and deck crew on the tug would be trained to handle and lay these booms for effective containment and recovery of spilled oil. Once the booms are in place, the skimmers are to be placed inside the area contained by the boom, and the oily water mixture pumped into the tug tanks or floating Tow able tank as per availability.

#### **8.4 MEDIA BRIEFING**

The HOD, Port Operation will prepare the Initial press statement in consultation with Manager – OSR (vendor) and release it after consultation with the Plant Head of PLL.

No other person is authorized to communicate with any external party by any means whatsoever unless expressly permitted by the Plant Head of PLL.

The standard format for Initial press statement is given in **Appendix-18**.

#### **8.5 PLANNING MEDIUM TERM OPERATIONS (24, 48 AND 72 HOUR)**

Medium term operations would depend upon the size of oil spill occurred. The recovery of oil would start only on containment of spilled oil and availability of suitable vessel along with the trained man power that can perform their duty in a cyclic order in the shifts. This again would depend on prevailing weather conditions and fate of movement of oil slick towards or away from the shore. In case oil slick hits the shore, shore cleanup is the only alternative and in case of slick remaining away from the coast, recovery has to be done by deployment of booms and skimmers. Use of dispersants / Bioremediation powder can also be resorted to as per the demand of the situation. The dispersant is to be sprayed over the oil slick by the ship’s spray system or by aircraft or helicopter subject to prior clearance from Coast Guard authorities.

#### **8.6 DECIDING TO ESCALATE RESPONSE TO HIGHER TIER**

Depending upon the feedback given by the OSC about the necessity of re assessing the spill quantity, the OSC and members of ECT will re-inspect the spill site and assess the oil slick thickness, its size, status of spilled oil and decide whether an upgraded

Section : 08	Oil Spill Contingency Plan	Page no. 62 of 108
Approved By:	Dahej LNG Port Terminal	Revision No. : 00 Issue No. : 00 Date: 21 Nov' 2016

response is desired or not. If ECT is convinced that response effort deserves revision upwards and the level accordingly of Tier needs to be raised, it will raise the oil spill reporting level accordingly. This will mean alerting higher oil spill response activities as well as alert other helping agencies, for example Coast Guard Authorities, Port authorities etc.

### **8.7 MOBILISING OR PLACING ON STANDBY RESOURCES REQUIRED**

With the decision to raise the response level, a review of existing oil spill response capability and additional infrastructure requirement shall also be done simultaneously. Once it is felt that additional resources are required, the concerned agencies are to be alerted immediately, and mobilization action for those equipment / items shall be initiated without losing any time.

Following is to be planned simultaneously:

- Additional manpower to operate the OSR equipment
- Material handling equipment and manpower to unload/load these equipment at required places
- Accommodation and food arrangements for these personnel.

### **8.8 ESTABLISHING FIELD COMMAND POST AND COMMUNICATIONS**

Here in this case, OSC will be equipped with VHF (Walkie Talkie) and mobile phone. The OSR Manager – vendor would also be having hand held VHF sets. (They can also be provided temporarily with mobile phones) It is to be kept in mind that in tier response state 2, one ERT member along with individual team leaders will be working under the direction of CG who takes over the operations. After this the OSC shall take directives from these superior formations, and will keep ECR also informed, if ECR and CG or any other OSR agency.

Section : 08	Oil Spill Contingency Plan	Page no. 63 of 108
Approved By:	Dahej LNG Port Terminal	Revision No. : 00 Issue No. : 00 Date: 21 Nov' 2016

# **CHAPTER – 9**

## **CONTROL OF OPERATIONS**

Section : 09	Oil Spill Contingency Plan	Page no. 64 of 108
Approved By:	Dahej LNG Port Terminal	Revision No. : 00 Issue No. : 00 Date: 21 Nov' 2016

## 9.1 ESTABLISHING A MANAGEMENT TEAM WITH EXPERTS AND ADVISORS

Emergency Control Team has been constituted with Experts and Advisors with operations head as IC. The members of the Executive Advisory Committee shall be:

- a) Plant Head - Incident Controller (IC)
- b) HOD, Port Operations - On Scene Commander (OSC)
- c) OSR Manager – Vendor
- d) Sr. Manager / Manager
- e) HOD, HSE / Fire Safety
- f) Shift Duty Officer
- g) Master of Tug (under Port Manager – Vendor)

## 9.2 UPGRADING INFORMATION (SEA/WIND/WEATHER FORECASTS, AERIAL SURVEILLANCE, BEACH REPORTS)

PLL Radio Room shall be entrusted with the responsibility of providing initial information of ESR / ERT / OSC for decision making pertaining to wind direction & speed, water current, tide position at the time of oil spill, high water & low water timings, sea condition, swell/wave heights, weather forecasts and existing weather warning, navigational warnings, any Coast Guard or any other resource agency air craft or helicopter sighted /in contact, any other relevant information available. All these information are to be provided to Emergency Control Room (ECR) automatically the moment information about OIL SPILL is received. In addition, regular inputs to be obtained from local sources regarding health of the surrounding coastal areas.

## 9.3 REVIEWING AND PLANNING OPERATIONS

The ongoing Operations shall be assessed and reviewed by ECT, as and when they consider it necessary or suggested by OSC. This is necessary to upgrade the level of operations or scale down the operations due to changing prevailing factors. Review of operations is an ongoing process and accordingly the planning is to be reoriented to maximize the utilization of men and machinery without compromising on safety of both. The OSC shall plan operational rest to men and machinery and the men in response teams shall be rotated at regular intervals. Continuous running machinery also needs rest after certain stipulated continuous running hours.

## 9.4 OBTAINING ADDITIONAL EQUIPMENTS, SUPPLIES AND MANPOWER

For obtaining additional equipment, the following shall be done by the ECT:

Section : 09	Oil Spill Contingency Plan	Page no. 65 of 108
Approved By:	Dahej LNG Port Terminal	Revision No. : 00 Issue No. : 00 Date: 21 Nov' 2016

- a) Contact local Oil (E&P) Companies and nearby ports. (Note: Their equipment suitability has to be assessed before hand and a Memorandum of Understanding (MoU) shall be signed before any oil spill occurrence).
- b) Requirement of extra manpower to meet the requirement of running these equipment
- c) Logistics support for the extra equipment and men shall be planned, so that time and effort is not wasted in allocation of assignments in case of Oil Spill, a general alert can be sounded to these Friendly Members by IC,ECT or the Asset Manager (Memorandum of Understanding sharing Organizations) requesting to keep the required items, as stand by.

### 9.5 PREPARING DAILY INCIDENT LOG AND MANAGEMENT REPORTS

During daily operations, every person in ECT, OSC and his team leaders are to fill up personal and other types of logs, pertaining to running of the equipment at the earliest possible opportunity, as while filling it later, chances of vital information getting missed or diluted are more. However at the end of the day, preferably time ending at 2000 hours starting from 2001 hours of the previous day, (it may be from 0801 hours to 0800 hours of the previous day) a daily summery of events shall be prepared and submitted to the leader of ECR, who in turn shall prepare the report consulting all the members of the ECR and forward it to management. This report shall cover following aspects:

- Present Location
- Number of manpower deployed
- Equipment deployed
- Weather conditions encountered
- Amount of oil recovered from sea
- Amount of oil transferred for storage /disposal
- Progress on shore cleaning efforts (as the case may be)
- Difficulties encountered
- Lessons learnt

A draft Daily Incident Log is given in **Appendix-19**.

### 9.6 PREPARING OPERATIONS ACCOUNTING AND FINANCING REPORTS

The financial aspect shall be looked after by F&A Department. It is advisable if their one

Section : 09	Oil Spill Contingency Plan	Page no. 66 of 108
Approved By:	Dahej LNG Port Terminal	Revision No. : 00 Issue No. : 00 Date: 21 Nov' 2016

member is always in the ECR to take stock of the situation and prepare the accounts and reports on day to day basis.

## **9.7 PREPARING RELEASES FOR PUBLIC AND PRESS CONFERENCE**

As already mentioned earlier also in section 8.4, only The Plant Head or Business Head and the Corporate communications cell will formulate the requisite press releases from time to time and hold press conferences.

## **9.8 BRIEFING LOCAL AND GOVERNMENT OFFICIALS**

The Plant Head or Business Head and the corporate communications cell will formulate the requisite reports to brief local and government officials. It is always advisable to keep concern Govt. agency like Coast Guard, GMB, DG Shipping and MoS informed about future operation plans.

Section : 09	Oil Spill Contingency Plan	Page no. 67 of 108
Approved By:	Dahej LNG Port Terminal	Revision No. : 00 Issue No. : 00 Date: 21 Nov' 2016

# CHAPTER – 10

## TERMINATION OF OPERATIONS

Section : 10	Oil Spill Contingency Plan	Page no. 68 of 108
Approved By:	Dahej LNG Port Terminal	Revision No. : 00 Issue No. : 00 Date: 21 Nov' 2016

## **10. TERMINATION OF OPERATIONS**

The termination of the operation shall be decided by the Plant Head on feedback received from ECT and OSC. Regulating authorities, like CG, GPCB etc. shall also be contacted before coming to this decision

### **10.1 DECIDING FINAL AND OPTIMAL LEVELS OF BEACH CLEAN-UP**

Since, there are no beaches in the vicinity of Dahej port available, no need of detailed final decision and optimal levels. However, if at all a distant beach is affected, which there are nil chances, the Plant Head, PLL will decide the optimal levels of cleanup in consultation with the conservator of the port-Gujarat Maritime Board Port Officer. The other authorities/agencies i.e. Coast Guard, GPCB, State Forest and Fisheries department officials etc. are to be consulted prior to starting, during and terminating beach clean-up operations.

### **10.2 STANDING-DOWN EQUIPMENT, CLEANING, MAINTAINING, REPLACING**

On completion of Pollution Response Operations, all the equipment, machineries and consumables shall be accounted for and checked for their serviceability. Considering the natural disintegration of the residual oil on water after the cleanup of the bulk amount, the head will decide when to stand down the response. The resources which have been used will have to be re-instated to the original condition by elaborate cleanup or replacement. All equipment and machineries shall be thoroughly washed with fresh water as per the OEM's guidelines, necessary for maintenance and then the equipment stored, and secured in their respective places

### **10.3 PREPARING FORMAL DETAILED REPORT**

After completion of operations, the OSC shall prepare a detailed report covering all the aspects of the oil spill clean-up, which shall include success and failures, as well as lessons learnt, recommendations about equipment, man power, plans etc. The report is to be forwarded to Leader, ECT / ECR in consultation with the Business Head's Office head and the corporate communications cell.

### **10.4 REVIEWING PLANS AND PROCEDURES FROM LESSONS LEARNT**

A complete spill response report will be produced by the OSC in association with OSR - Manager providing comprehensive and all-inclusive details of the circumstances leading to the spill, initial response and consequent effect of the

Section : 10	Oil Spill Contingency Plan	Page no. 69 of 108
Approved By:	Dahej LNG Port Terminal	Revision No. : 00 Issue No. : 00 Date: 21 Nov' 2016



same, subsequent follow up, effect of prevailing weather, adverse situations, safety issues, difficulties faced and lessons learnt.

Such a report will also be prepared by the OSC in association with OSR-Manager after each drill or training session and requisite modification(s) incorporated to the plan in order to enhance the overall efficacy of the same. It is recommended that this plan be reviewed after 3 years or increase in traffic of 100% whichever is earlier.

Section : 10	Oil Spill Contingency Plan	Page no. 70 of 108
Approved By:	Dahej LNG Port Terminal	Revision No. : 00 Issue No. : 00 Date: 21 Nov' 2016

# DATA

# DIRECTORY

Section : APPENDICES	Oil Spill Contingency Plan	Page no. 71 of 108
Approved By:	Dahej LNG Port Terminal	Revision No. : 00 Issue No. : 00 Date: 21 Nov' 2016

## APPENDICES

APPENDIX - 01	Geographic Limites of Plan
APPENDIX - 02	Sensitive Coastal Areas as per Coast Guard Website
APPENDIX - 03	Mud Flats Shoreline Clean-up Techniques
APPENDIX - 04	Current Directions
APPENDIX - 05	Oil Spill Response Decision Tree
APPENDIX - 06	Option for Separation and Disposal of Oil & Debris
APPENDIX - 07	GPCB approved Oil Recyclers
APPENDIX - 08	List of Tier-1OSR Equipment
APPENDIX - 09	List of Shoreline Cleanup Equipment and Materials
APPENDIX - 10	Incident Organisation Chart
APPENDIX -11	Advisor and Consultants List
APPENDIX -12	Training and Competency
APPENDIX -13	Oil Spill Report Forms
APPENDIX -14	Personal Log Form
APPENDIX -15	Communication Channel
APPENDIX -16	Telephone Directory
APPENDIX -17	Afloat & Ashore OSR Teams
APPENDIX -18	Initial Press Statement
APPENDIX -19	Daily Incident Log

Section : APPENDICES	Oil Spill Contingency Plan	Page no. 72 of 108
Approved By:	Dahej LNG Port Terminal	Revision No. : 00 Issue No. : 00 Date: 21 Nov' 2016

**GEOGRAPHIC LIMITS OF PLL: DAHEJ PORT LIMITS**



Section : APPENDICES	Oil Spill Contingency Plan	Page no. 73 of 108
Approved By:	Dahej LNG Port Terminal	Revision No. : 00 Issue No. : 00 Date: 21 Nov' 2016

**GEOGRAPHIC LIMITS OF PORT: PETRONET LNG /PLL JETTY**



Section : APPENDICES	Oil Spill Contingency Plan	Page no. 74 of 108
Approved By:	Dahej LNG Port Terminal	Revision No. : 00 Issue No. : 00 Date: 21 Nov' 2016

## GEOGRAPHIC LIMITS OF PLL: DAHEJ PORT LOCATION

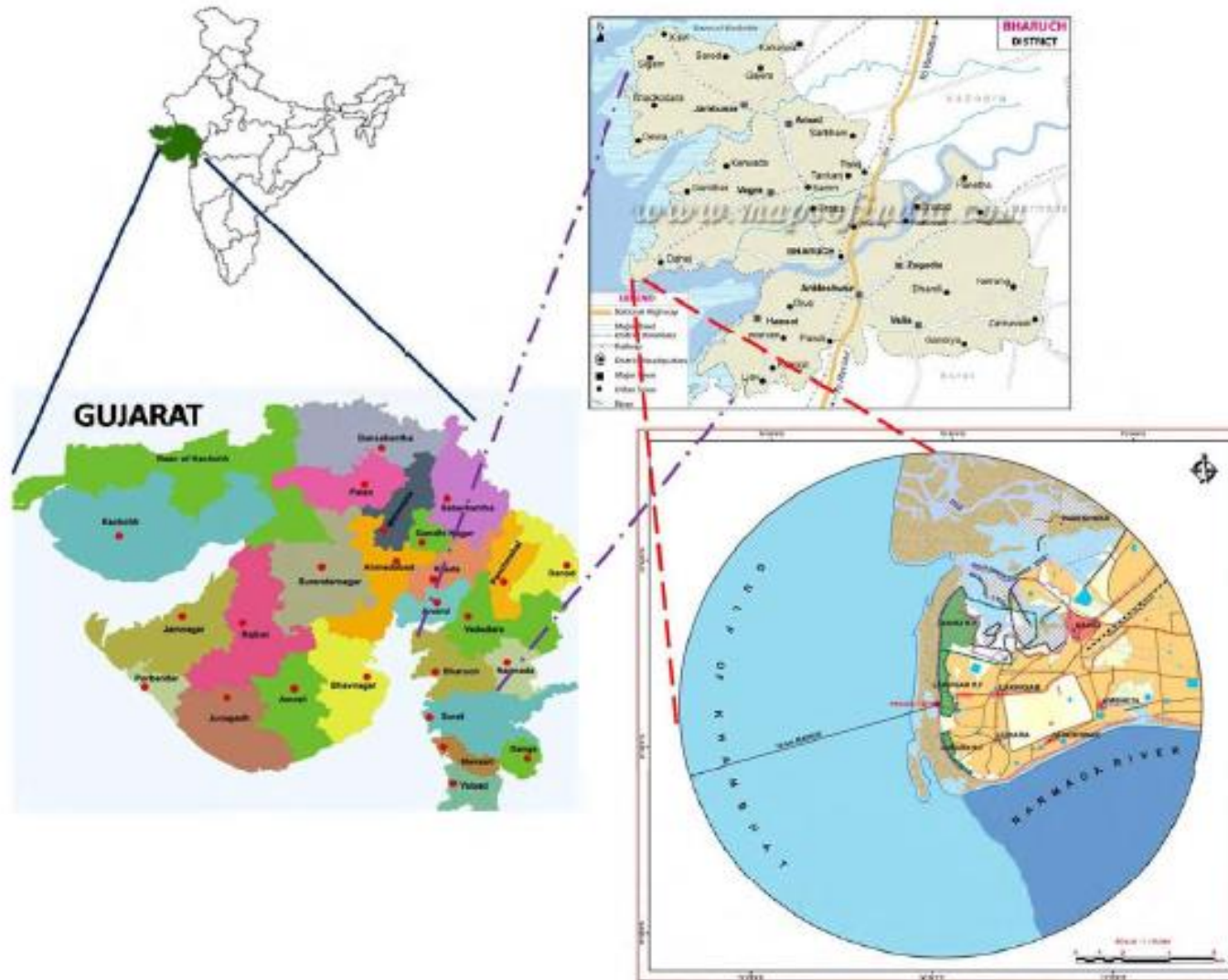

Section : APPENDICES	Oil Spill Contingency Plan	Page no. 75 of 108
Approved By:	Dahej LNG Port Terminal	Revision No. : 00 Issue No. : 00 Date: 21 Nov' 2016

SENSITIVITY MAPPING

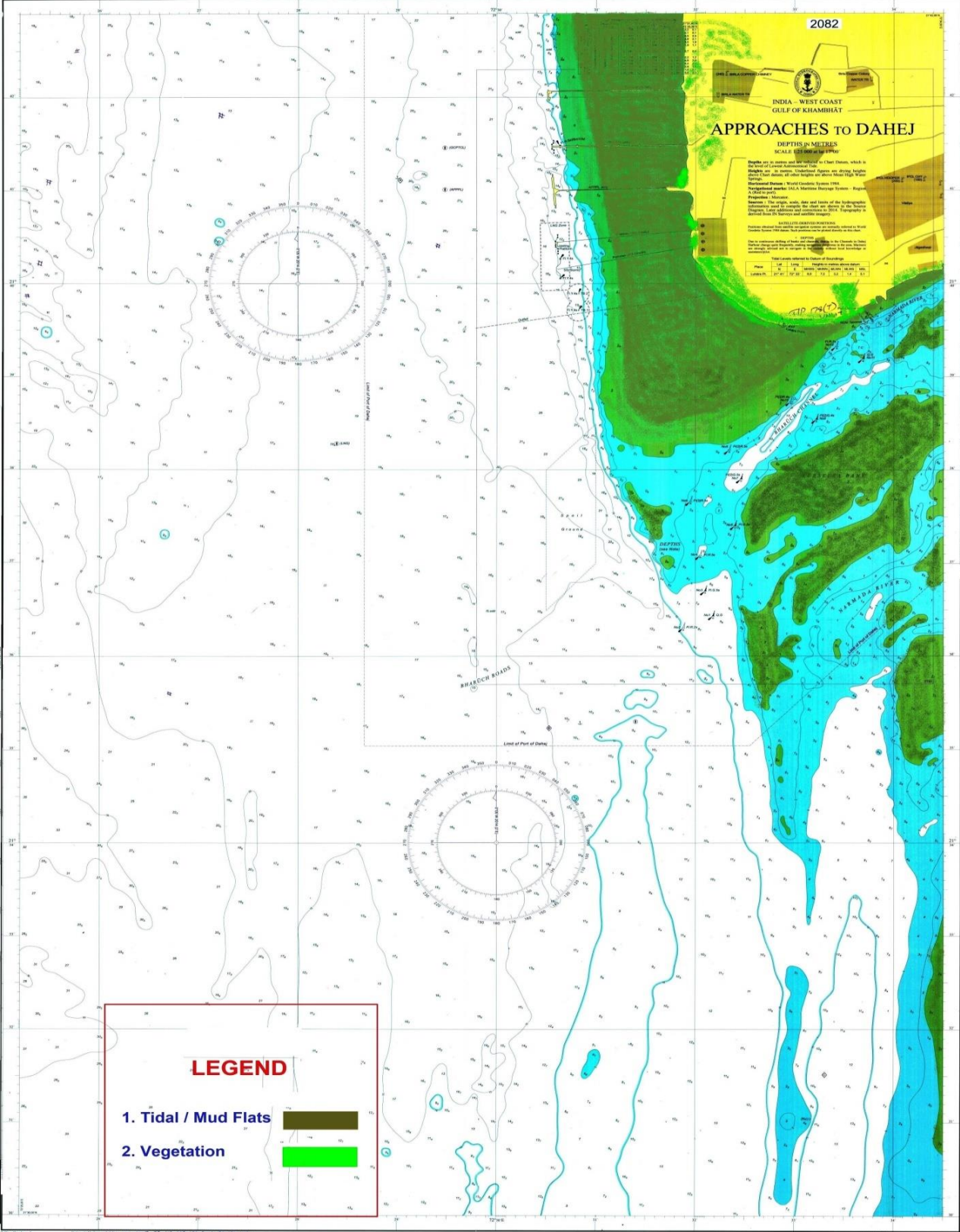

Section : APPENDICES	Oil Spill Contingency Plan	Page no. 76 of 108
Approved By:	Dahej LNG Port Terminal	Revision No. : 00 Issue No. : 00 Date: 21 Nov' 2016

# SENSITIVE COASTAL AREAS



Section : APPENDICES	Oil Spill Contingency Plan	Page no. 77 of 108
Approved By:	Dahej LNG Port Terminal	Revision No. : 00 Issue No. : 00 Date: 21 Nov' 2016



MUD FLAT SHORELINE CLEANUP TECHNIQUE

Exposed Tidal Flats

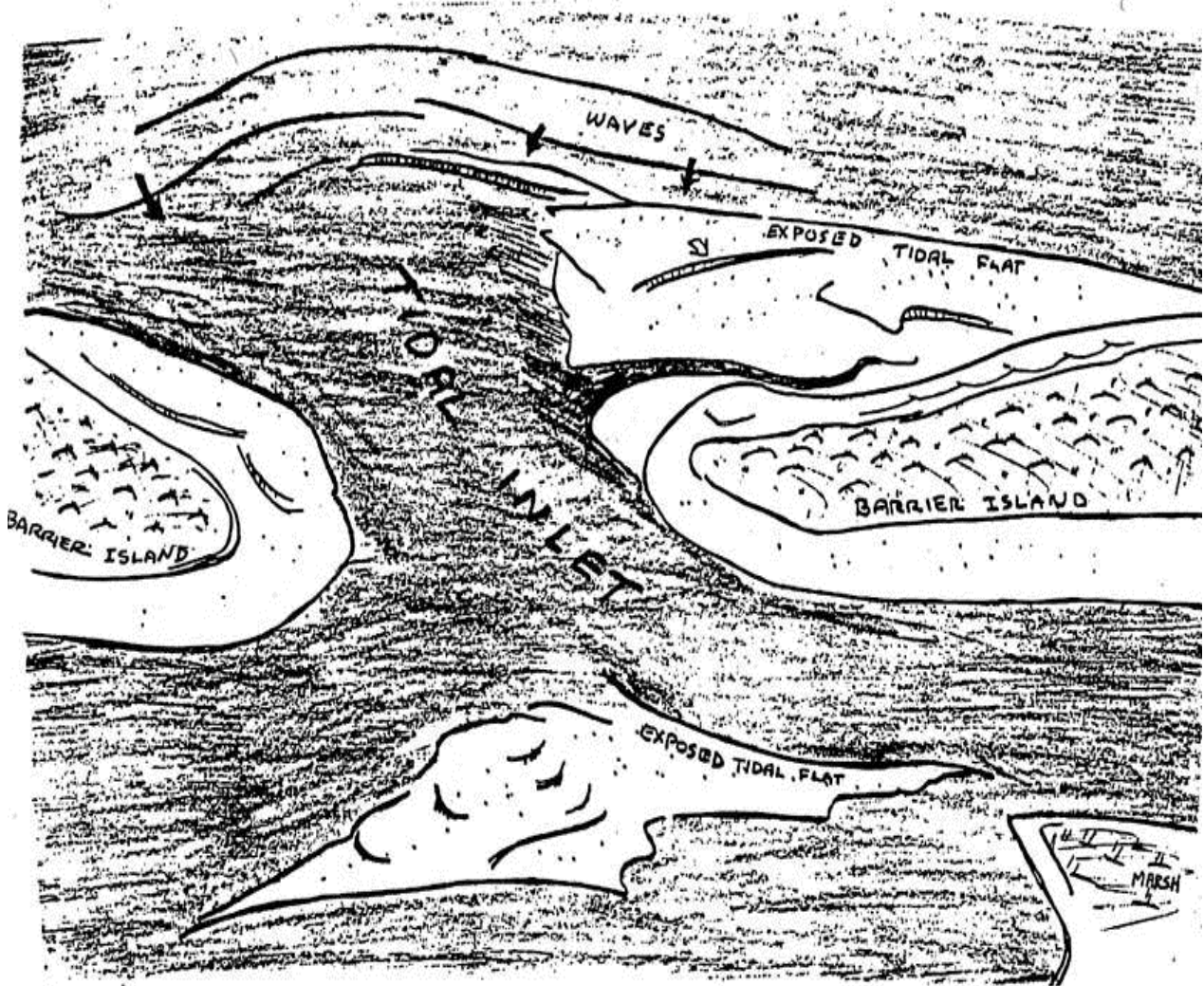

Description

- They are composed primarily of sand and mud.
- The presence of sand indicates that tidal or wind-driven currents and waves are strong enough to mobilize the sediments.
- They are always associated with another shoreline type on the landward side of the flat.
- The sediments are water-saturated, with only the topographically higher ridges drying out during low tide.
- Biological utilization can be very high, with large numbers of infauna and heavy use by birds for roosting and foraging.

Section : APPENDICES	Oil Spill Contingency Plan	Page no. 78 of 108
Approved By:	Dahej LNG Port Terminal	Revision No. : 00 Issue No. : 00 Date: 21 Nov' 2016

### **Predicted Oil Impact**

- Oil does not usually adhere to the surface of exposed tidal flats, but rather moves across the flat and accumulates at the high-tide line.
- Deposition of oil on the flat may occur on a falling tide if concentrations are heavy.
- Oil does not penetrate the water-saturated sediments.
- Biological damage may be severe, primarily to infauna, thereby reducing food sources for birds and other predators.

### **Recommended Response Activity**

- Currents and waves can be very effective in natural removal of the oil.
- Cleanup is very difficult (and possible only during low tides).
- The use of heavy machinery should be restricted to prevent mixing of oil into the sediments.
- On sand flats, oil will be removed naturally from the flat and deposited on the adjacent beaches where cleanup is more feasible.

Section : APPENDICES	Oil Spill Contingency Plan	Page no. 79 of 108
Approved By:	Dahej LNG Port Terminal	Revision No. : 00 Issue No. : 00 Date: 21 Nov' 2016

**CURRENT DIRECTIONS**

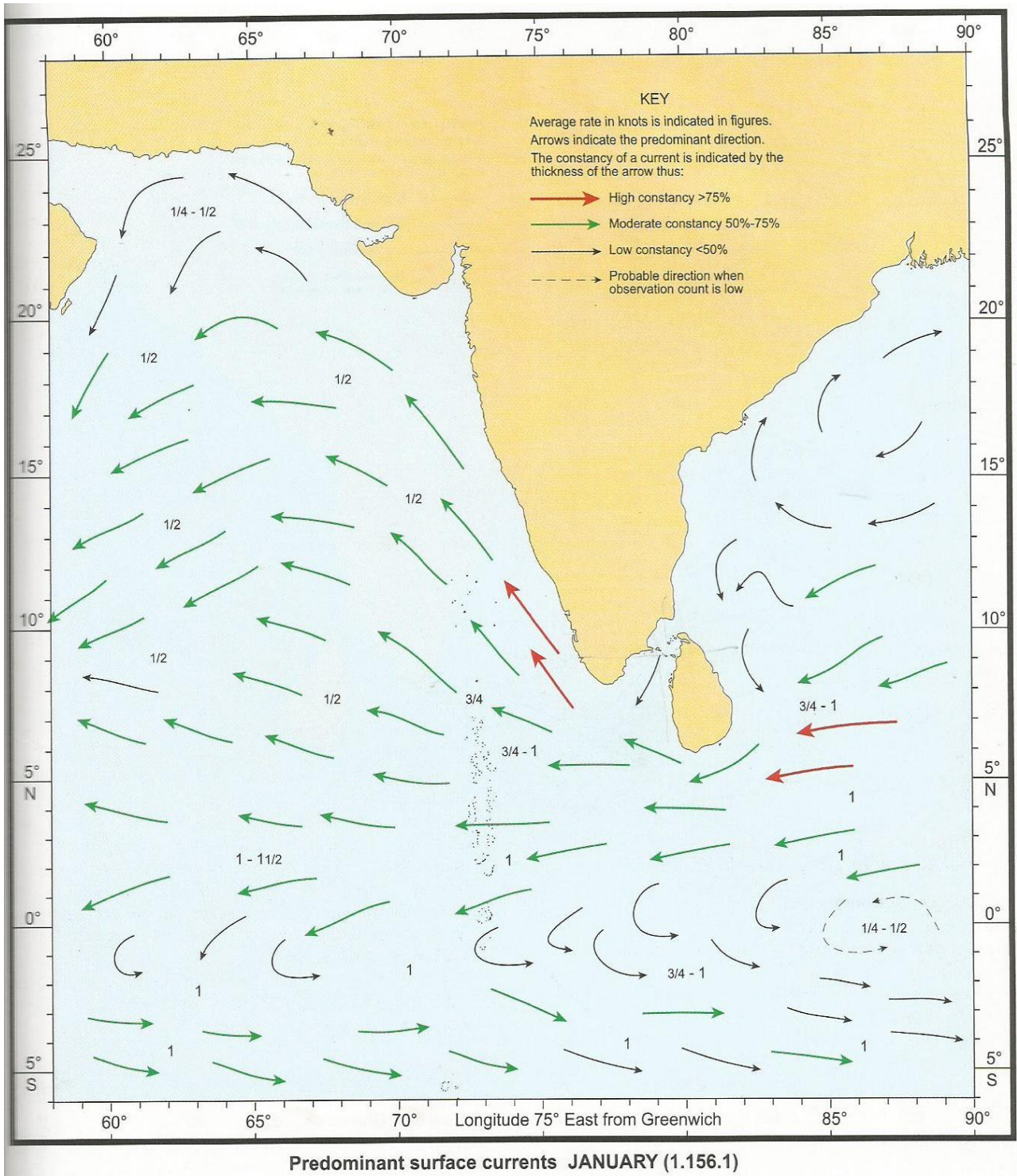

Section : APPENDICES	Oil Spill Contingency Plan	Page no. 80 of 108
Approved By:	Dahej LNG Port Terminal	Revision No. : 00 Issue No. : 00 Date: 21 Nov' 2016

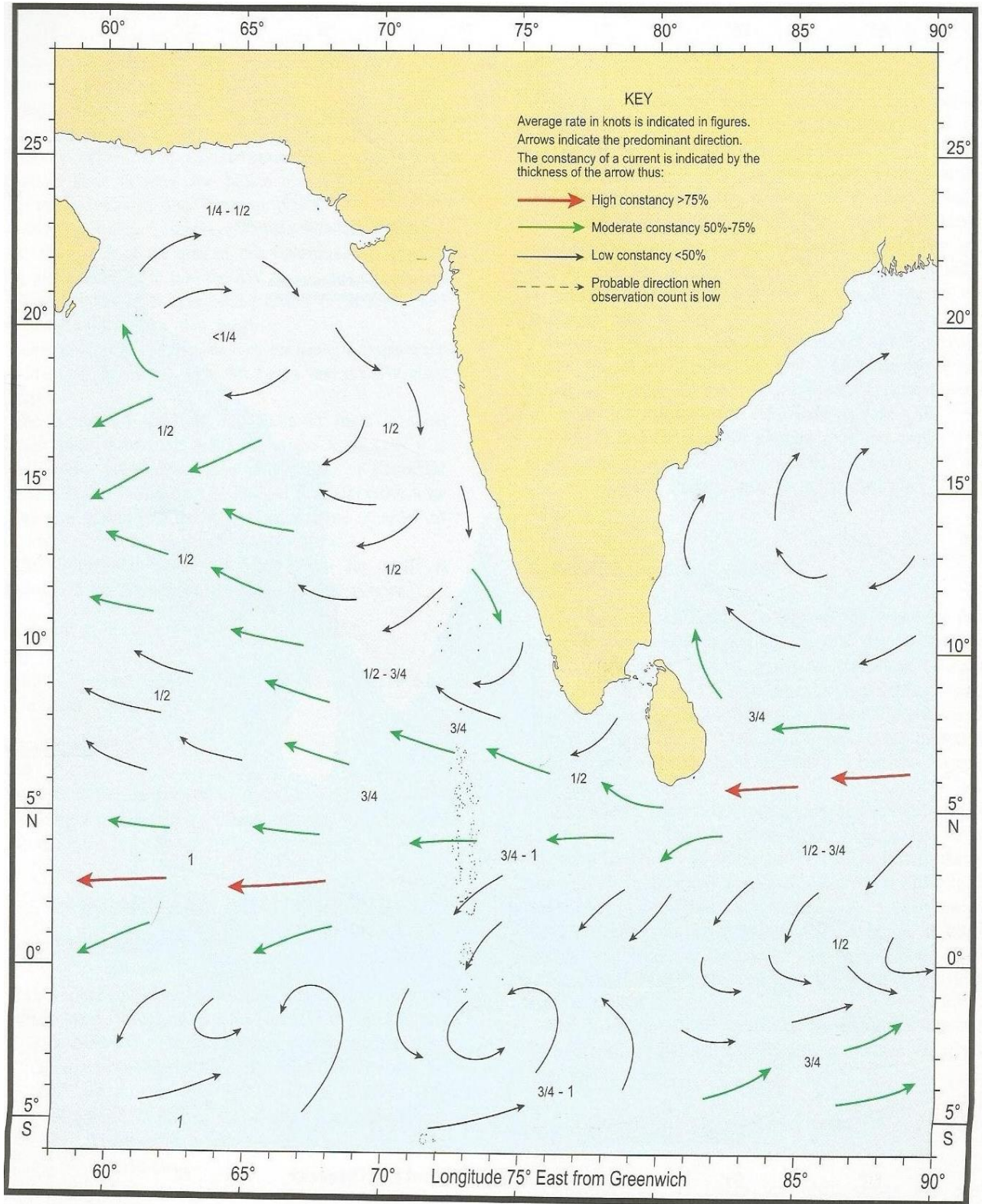

Predominant surface currents MARCH (1.156.2)

Section : APPENDICES	Oil Spill Contingency Plan	Page no. 81 of 108
Approved By:	Dahej LNG Port Terminal	Revision No. : 00 Issue No. : 00 Date: 21 Nov' 2016

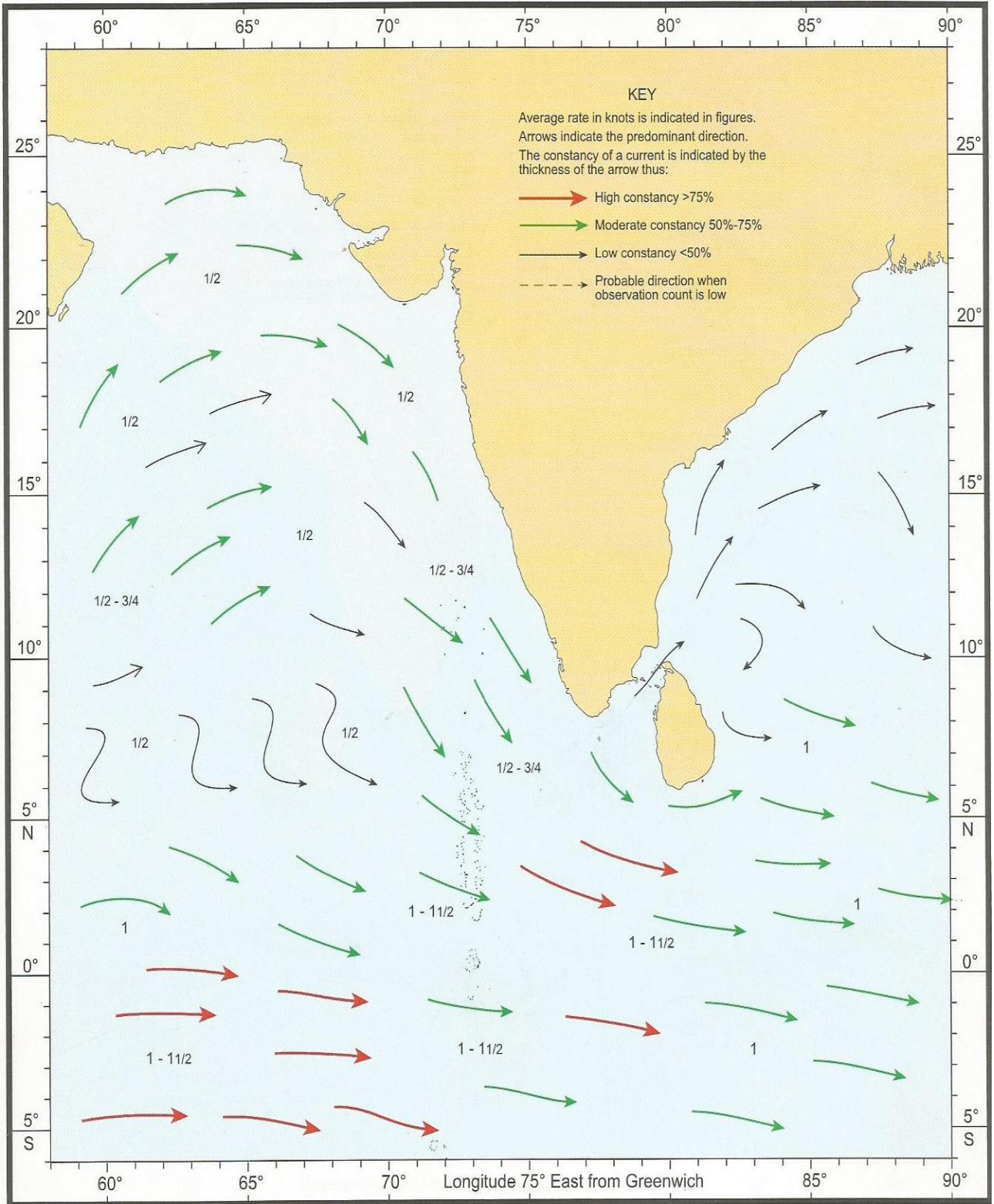

**Predominant surface currents MAY (1.156.3)**

Section : APPENDICES	Oil Spill Contingency Plan	Page no. 82 of 108
Approved By:	Dahej LNG Port Terminal	Revision No. : 00 Issue No. : 00 Date: 21 Nov' 2016

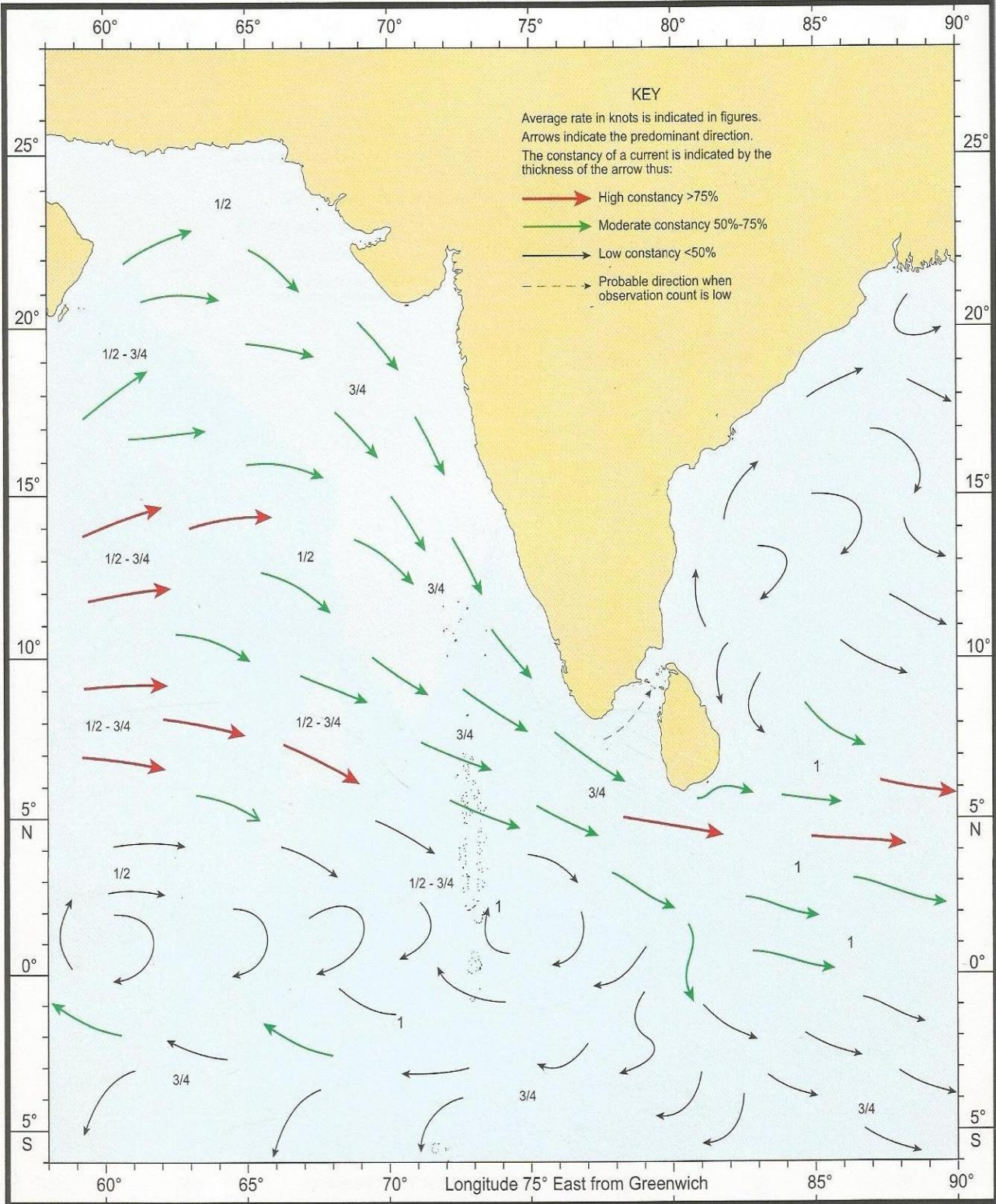

**Predominant surface currents JULY (1.156.4)**

Section : APPENDICES	Oil Spill Contingency Plan	Page no. 83 of 108
Approved By:	Dahej LNG Port Terminal	Revision No. : 00 Issue No. : 00 Date: 21 Nov' 2016

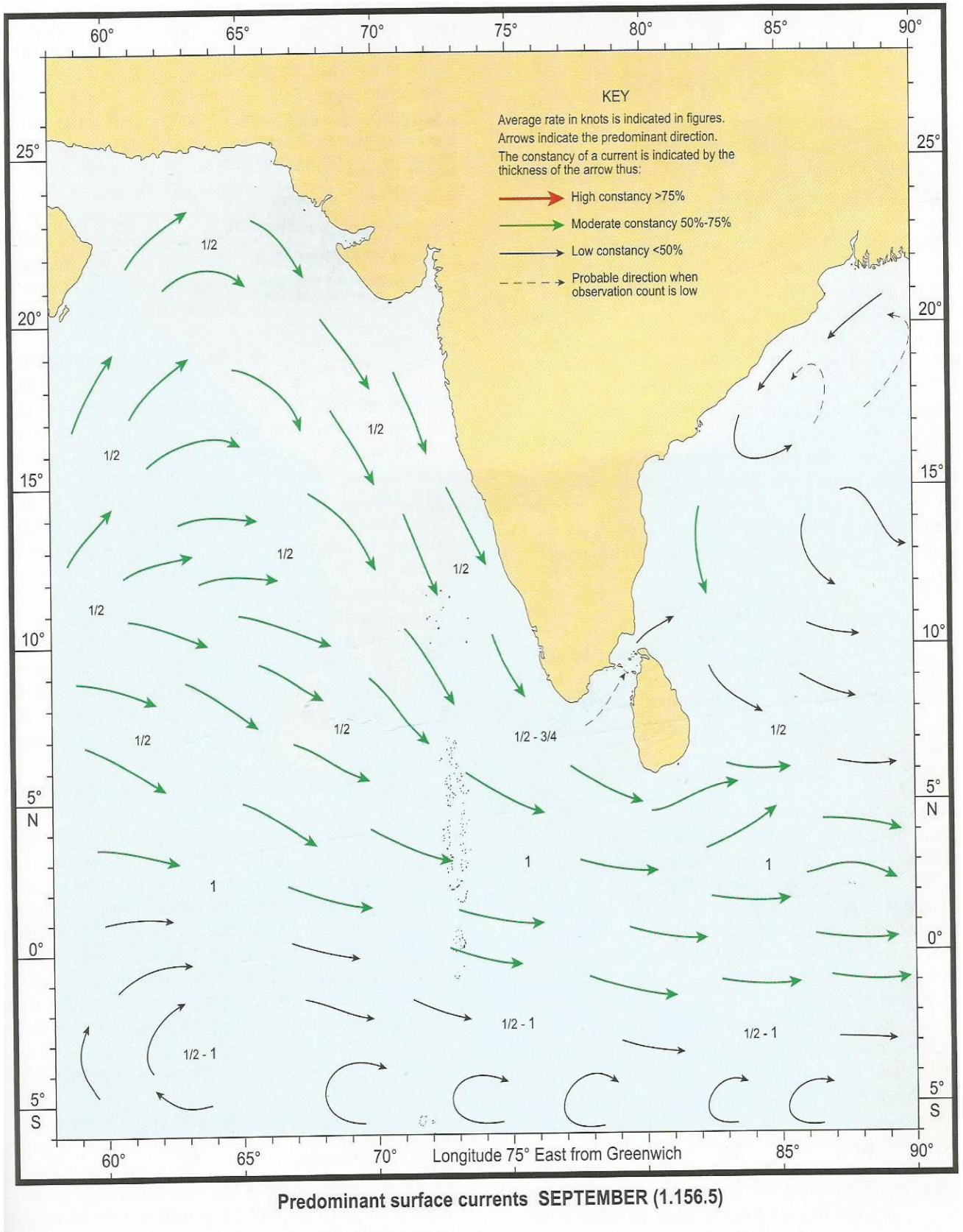

Section : APPENDICES	Oil Spill Contingency Plan	Page no. 84 of 108
Approved By:	Dahej LNG Port Terminal	Revision No. : 00 Issue No. : 00 Date: 21 Nov' 2016

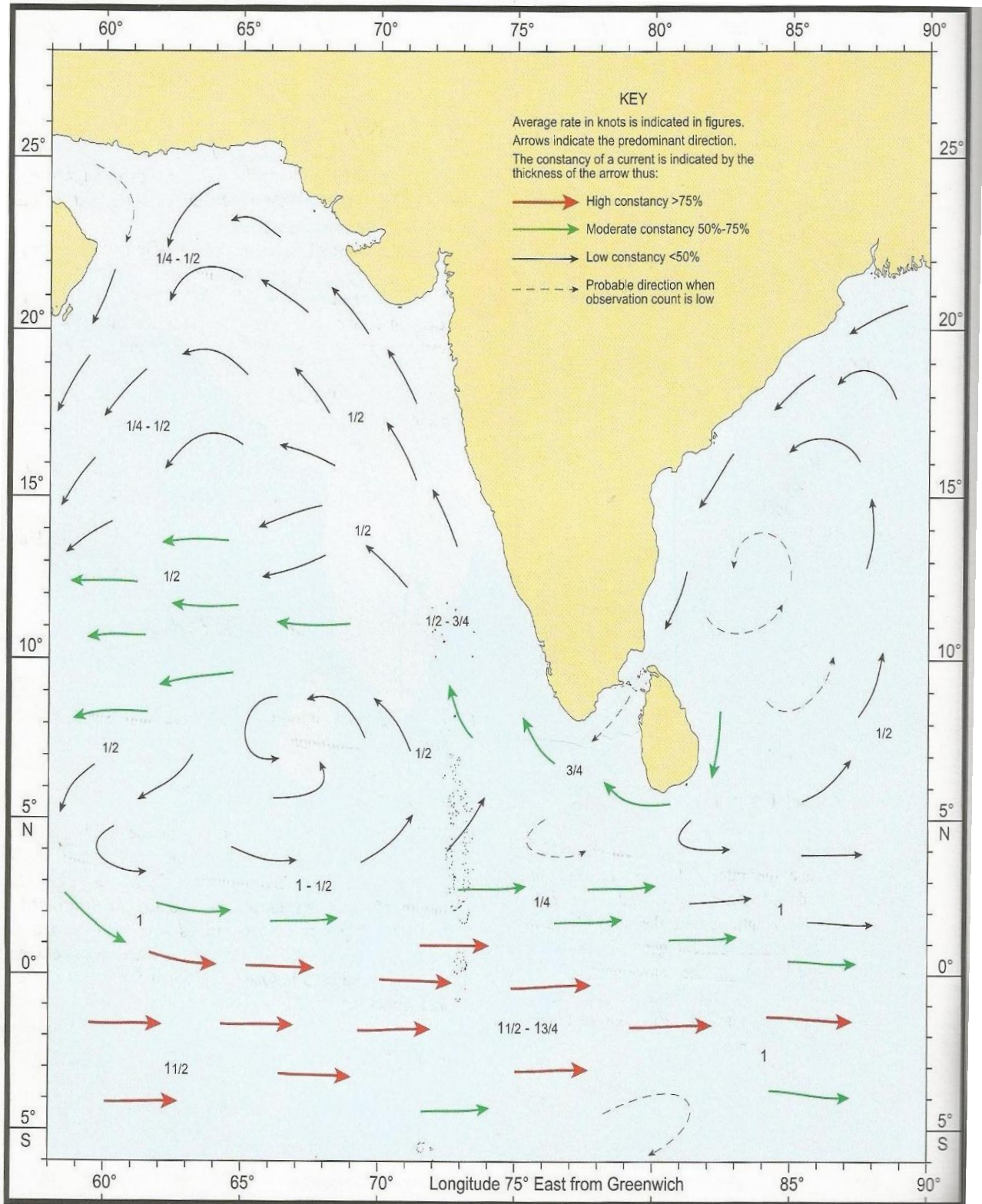

**Predominant surface currents NOVEMBER (1.156.6)**

Section : APPENDICES	Oil Spill Contingency Plan	Page no. 85 of 108
Approved By:	Dahej LNG Port Terminal	Revision No. : 00 Issue No. : 00 Date: 21 Nov' 2016



**VERĀVAL (20°54'N, 70°22'E) Height above MSL - 8 m**  
 Climatic Table compiled from 15 to 30 years observations, 1960 to 1997

Month	Average pressure at MSL	Temperatures				Average humidity		Average cloud cover		Precipitation		Wind distribution - Percentage of observations from																				Mean wind speed		Number of days with		
		Mean daily max.	Mean daily min.	Mean highest in each month	Mean lowest in each month	0830	1730	0830	1730	Average fall	No. of days with 1 mm or more	0830										1730										0830	1730	Gale	Fog	Thunder
												N	NE	E	SE	S	SW	W	NW	Calm	N	NE	E	SE	S	SW	W	NW	Calm							
January	hPa 1015	°C 29	°C 15	°C 31	°C 12	% 65	% 61	Oktas 1	1	mm 1	0	25	55	8	⊕	1	0	⊕	8	3	13	6	1	2	6	9	32	30	⊕	Knots 5 9		⊕	1	⊕		
February	1013	30	16	35	13	68	65	1	<1	1	0	34	41	4	1	0	1	2	15	2	2	4	0	2	4	7	49	32	0	5	10	⊕	1	0		
March	1012	32	19	38	16	69	74	1	1	0	0	38	23	2	1	0	0	7	24	5	1	0	0	1	3	4	57	34	0	5	10	⊕	1	0		
April	1009	32	22	39	20	76	77	2	1	1	0	30	4	1	0	1	1	13	44	5	1	⊕	0	1	1	5	64	28	0	5	11	⊕	1	⊕		
May	1007	32	26	35	23	82	79	3	2	1	0	9	1	0	⊕	4	7	46	33	1	⊕	1	0	⊕	1	6	75	17	0	7	11	⊕	1	⊕		
June	1003	32	27	35	25	85	81	5	5	207	7	2	2	1	1	4	14	59	17	1	1	1	0	2	7	20	62	7	1	9	12	⊕	1	1		
July	1002	31	26	33	23	88	85	7	7	229	13	1	1	0	2	2	20	68	6	1	1	1	0	1	3	15	74	7	⊕	13	14	⊕	1	1		
August	1004	30	25	31	23	89	85	7	7	168	13	⊕	1	1	1	2	12	70	12	2	⊕	⊕	0	0	1	10	80	9	⊕	11	11	⊕	1	⊕		
September	1007	31	25	34	23	87	81	4	4	79	6	15	4	2	⊕	2	3	40	25	10	2	⊕	⊕	0	3	8	60	26	1	7	9	⊕	1	1		
October	1010	34	23	38	21	73	73	2	2	15	1	24	39	7	1	⊕	2	4	16	6	1	2	1	6	11	11	45	22	1	5	8	⊕	1	1		
November	1013	33	20	37	16	60	65	1	1	33	1	25	62	5	⊕	1	0	1	5	1	3	3	1	14	17	9	33	17	3	5	6	⊕	1	0		
December	1015	31	17	34	13	61	63	1	1	0	0	23	65	5	⊕	⊕	1	1	3	1	11	6	1	14	15	8	24	20	2	5	7	1	⊕	0		
Means	1009	31	22	40*	11§	75	74	3	3	-	-	19	25	3	1	1	5	26	17	3	3	2	⊕	4	6	9	54	21	1	7	10	-	-	-		
Totals	-	-	-	-	-	-	-	-	-	735	41	-	-	-	-	-	-	-	-	-	-	-	-	-	-	-	-	-	-	-	-	1	11	4		
Extreme values	-	-	-	44†	4‡	-	-	-	-	-	-	-	-	-	-	-	-	-	-	-	-	-	-	-	-	-	-	-	-	-	-	-	-	-		
No. of years observations	15	15				15		15		30		15										15										15	15	15	15	

\* Mean of highest each year  
 § Mean of lowest each year

† Highest recorded temperature  
 ‡ Lowest recorded temperature

⊕ Rare  
 ⊖ All observations

Section : APPENDICES	Oil Spill Contingency Plan	Page no. 86 of 108
Approved By:	Dahej LNG Port Terminal	Revision No. : 00 Issue No. : 00 Date: 21 Nov' 2016

**OIL SPILL RESPONSE DECISION MAKING TREE**

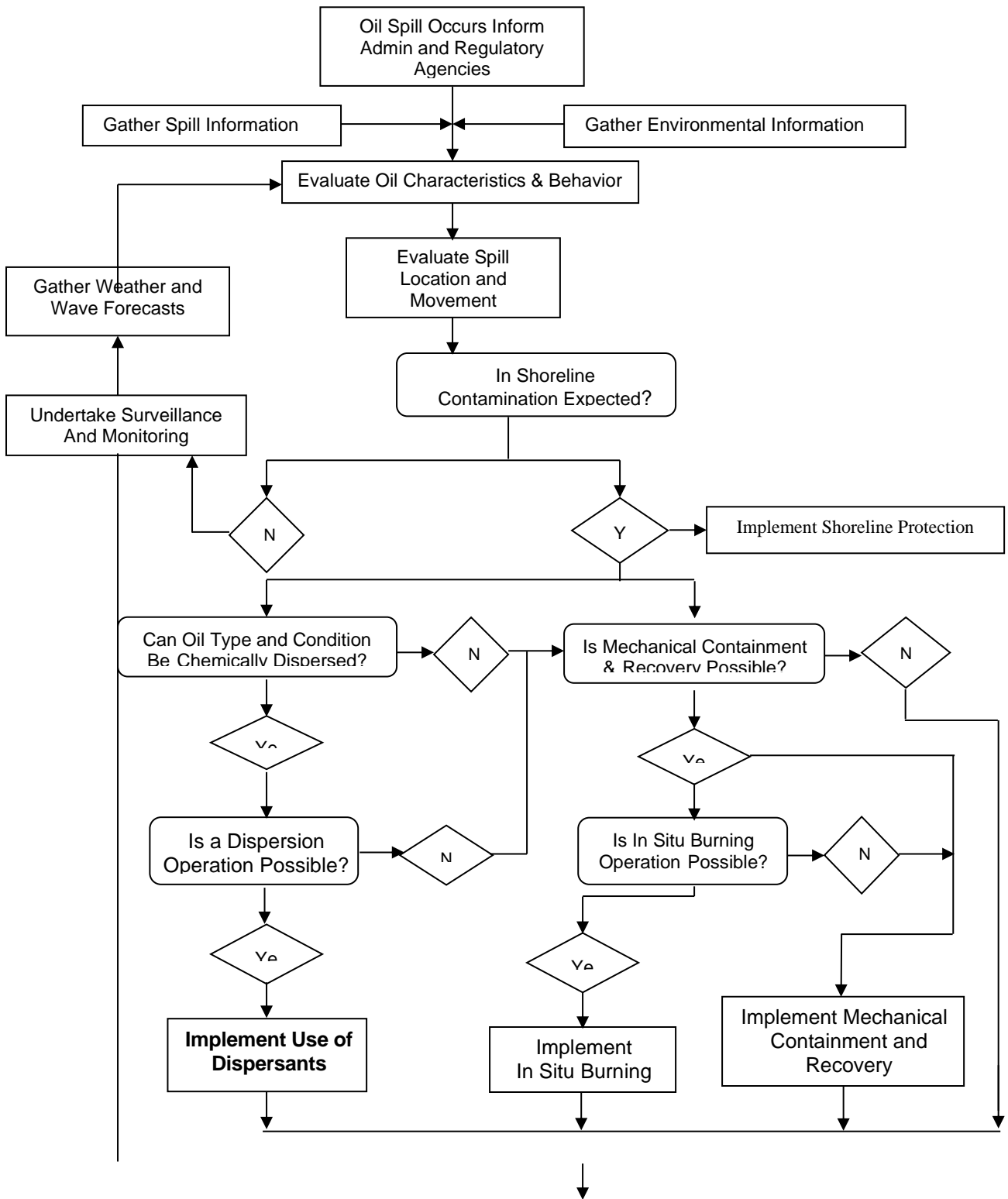

Section : APPENDICES	Oil Spill Contingency Plan	Page no. 87 of 108
Approved By:	Dahej LNG Port Terminal	Revision No. : 00 Issue No. : 00 Date: 21 Nov' 2016

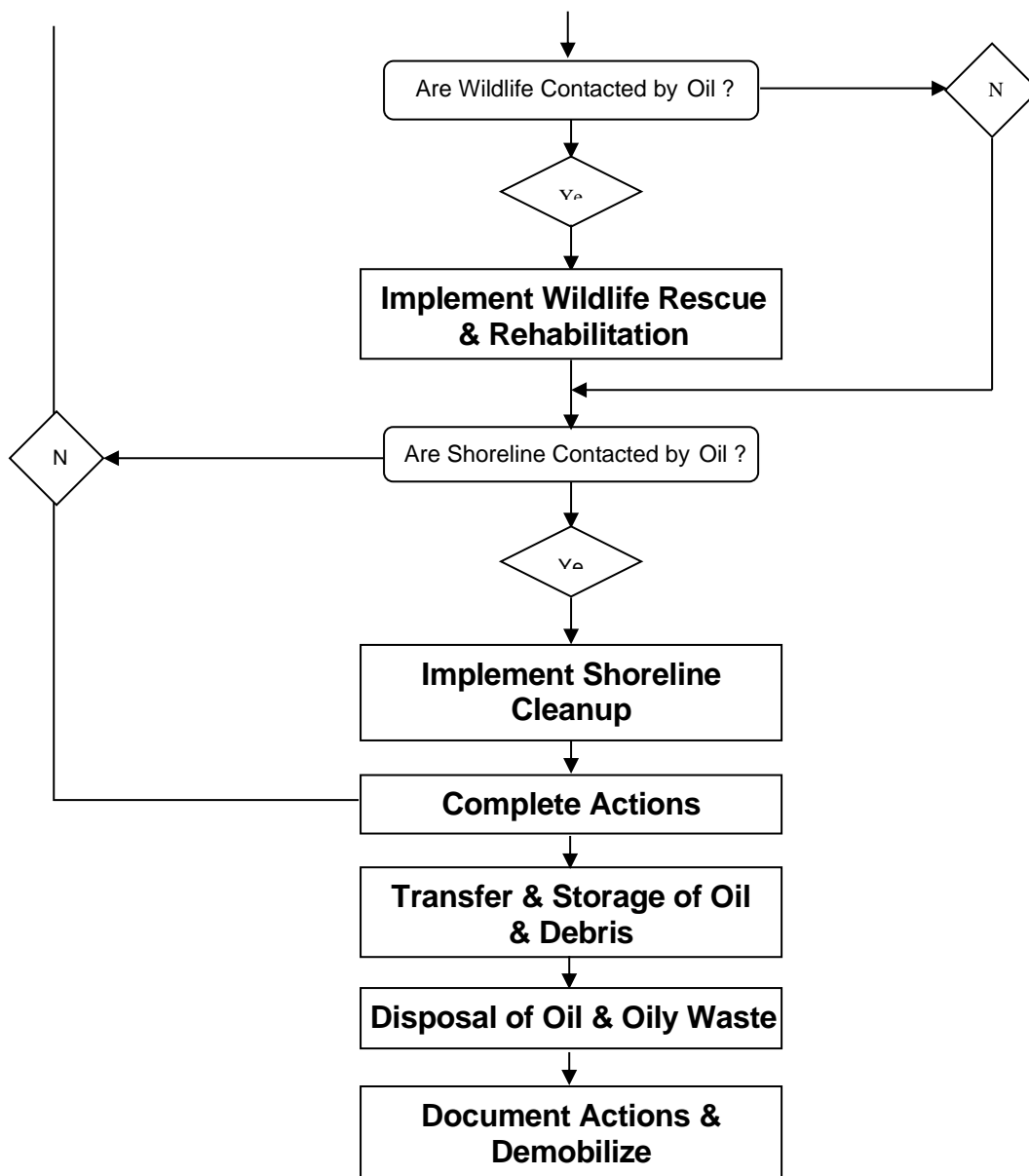

Section : APPENDICES	Oil Spill Contingency Plan	Page no. 88 of 108
Approved By:	Dahej LNG Port Terminal	Revision No. : 00 Issue No. : 00 Date: 21 Nov' 2016

**OPTION FOR SEPARATION AND DISPOSAL OF OIL AND DEBRIS**

<b>Types of Material</b>	<b>Separation Method</b>	<b>Disposal Method</b>
Liquids Non-emulsified oil	Gravity separation of free water	Use of recovered oil as fuel or refined feedstock.
Emulsified	Emulsion broken to ..... Water by heat treatment Emulsion broken chemicals Mixing with sand	Use of recovered oil on refined footstock. Return of separated sand to source
Solids oil mixed With sand	Collection of liquid oil leaching From sand during temporary Storage. Extraction of oil from sand by Washing with water on solvent. Removal of solid oil by sieving	Use of recovered oil as fuel on refinery food stock Direct disposal Stabilization with inorganic material Degradation through land farming on Composting burning
Oil mixed with wood, Plastics, seaweed and Sorbents	Collection of liquids from debris during temporary storage Flushing of oil from debris with Water	Direct disposal burning Degradation through land farming on composting oil mixed with seaweed on natural sorbents

Section : APPENDICES	Oil Spill Contingency Plan	Page no. 89 of 108
Approved By:	Dahej LNG Port Terminal	Revision No. : 00 Issue No. : 00 Date: 21 Nov' 2016

**APPENDIX-07****GPCB APPROVED OIL RECYCLERS – GUJARAT STATE**

<b>Sr. No</b>	<b>Name</b>	<b>E-mail ID</b>	<b>Contact No.</b>
1	Aadi Oil Pvt. Ltd., Sur No-41, Paiki, Mundra, SEZ Ta- Mundra. Dist- Kutch	<a href="mailto:oil@aadigroup.in">oil@aadigroup.in</a>	9714988220
2	Alicid organic Industries Ltd., Plot no: 208, Hanuman Henduva Nr. Khari River, Highway, Post: Palavasana, Mehsana-2	<a href="mailto:alicioil@yahoo.com">alicioil@yahoo.com</a>	9879104218
3	Alka Enterprises, Plot No.- 10, Panjetini Estate. Opp. P.W.D. Stores, Danilimda, Ahmedabad	<a href="mailto:alkaenterprises.ahd@gmail.com">alkaenterprises.ahd@gmail.com</a>	9824043322
4	Amafhh Petroleum, 60, GIDC, Vartej, Bhavnagar	<a href="mailto:ashokhinguaa@gmail.com">ashokhinguaa@gmail.com</a>	9879069545
5	Amar Hydrocarbon Pvt Ltd., Plot No.36, Sr. No.165/1 to 180, 1 & 2, Tal. Sanand, Ahmedabad	<a href="mailto:amarhydrocarbon@gmail.com">amarhydrocarbon@gmail.com</a>	9825429835
6	AN Lubricants, Plot no. 45, GIDC, Bhatpore- ichhapore-nr. GAIL colony, Bhatpore, Tal. Choryaci, Dist. Surat - 394510	<a href="mailto:an_lube@yahoo.co.in">an_lube@yahoo.co.in</a>	9825113718
7	Aroma Petrochem, 60, GIDC, Vartej, Bhavnagar	<a href="mailto:ashokhinguaa@gmail.com">ashokhinguaa@gmail.com</a>	9879069545
8	Atlas organics Pvt Ltd., Opp: PWD Store, Nr. Chandola Lake, Danilimda, Ahmedabad-28	<a href="mailto:atlasorganics@yahoo.com">atlasorganics@yahoo.com</a>	9825063459
9	Bombay Oil Company, Sur-362,363,366,487, Paiki,Plot No-14 & 24 Vill-Vatwa, Ta. Dascroi, Ahmedabad	<a href="mailto:bombayoilco@yahoo.in">bombayoilco@yahoo.in</a>	9426378651
10	Concept Petrochem, S.No. 249A, Plot 41/A, Vasna lyava, Vill. Sanand, Ahmdabad	<a href="mailto:conceptpetrochem@yahoo.co.in">conceptpetrochem@yahoo.co.in</a>	8879770906

Section : APPENDICES	Oil Spill Contingency Plan	Page no. 90 of 108
Approved By:	Dahej LNG Port Terminal	Revision No. : 00 Issue No. : 00 Date: 21 Nov' 2016

11	Deepak Petrochem Ltd., 56/2, rameshwar road, Vill. Vasenti, Tal. Halol, Panchmahal - 350	<a href="mailto:deepak_petrochem@yahoo.co.in">deepak_petrochem@yahoo.co.in</a>	2653080217
12	Goodluck Petroleum, Plot 118, GIDC, Limdi Highway Road, Ta-Limdi, Dist-Surendranagar	<a href="mailto:manojmakwana27@gmail.com">manojmakwana27@gmail.com</a>	9824562884
13	Jawrawala Petroleum, Plot # 200 / 33, B/H Kashiram Textile Mill, Narol, Ahmedabad -05	<a href="mailto:jawrapetro@yahoo.co.in">jawrapetro@yahoo.co.in</a>	9824045726
14	Jay Yogeshwar Petro Chemicals, 200, block no. 157, plot no 2/2, Vill. Malpar, Ghogha, Bhavnagar	<a href="mailto:jys_moto@yahoo.com">jys_moto@yahoo.com</a>	9426211891
15	Jodhpur Oil Industries, Panjetani Estate, Opp PWD-Stores., Danilibmda, Ahmedabad	<a href="mailto:jpoil_714@yahoo.in">jpoil_714@yahoo.in</a>	9824860452
16	Karam Petroleum Prodt. Pvt Ltd Plot no.1915, GIDC Sarigam, Umbergaon, Dist-Valsad, Gj	<a href="mailto:karamhusainkhan@yahoo.com">karamhusainkhan@yahoo.com</a>	9377014381
17	Mazda Industrol, Plot No.- 349 Vill- Sahol Bharuch	<a href="mailto:rukshadmaster@gmail.com">rukshadmaster@gmail.com</a>	9898055153
18	Navkar Enterprise, Block no. 185-186, Vill. Chachrvadi, Vasna, tal. Sanand, Ahemdabad - 382210	<a href="mailto:navkar.ent05@gmail.com">navkar.ent05@gmail.com</a>	9825063994
19	One-Ten Impex, Survey No.72-P1, Trapaj-364240, Alang Road, Ta-Talaja, Dist-Bhavnagar	<a href="mailto:onetenimpex@gmail.com">onetenimpex@gmail.com</a>	9825568114
20	Power Gold Petrochem Pvt. Ltd., Plot No.508/B/2, S. No. 436, Por -Utiya Road, Por, Vadodara	<a href="mailto:powergold99@gmail.com">powergold99@gmail.com</a>	9327710303
21	Priyansi Corporation, Shed no. C-1, 805-806, GIDC, Bamanbore Ta-Chotila, Di - Surendranagar	<a href="mailto:priyansicorpo@gmail.com">priyansicorpo@gmail.com</a>	9825059758
22	R K Steel, PI-No-21 GIDC Estate Ph-1, Narmadanagar, Bharuch		9825073658
23	Shana Petrochem, Opp. PWD stores, nr. Eagle trader, chandola lake, narol road, Ahemdabad - 28	<a href="mailto:shanapetrochem@yahoo.com">shanapetrochem@yahoo.com</a> <a href="mailto:shanaoilprocess@yahoo.com">shanaoilprocess@yahoo.com</a>	9825066725 9824438786

Section : APPENDICES	Oil Spill Contingency Plan	Page no. 91 of 108
Approved By:	Dahej LNG Port Terminal	Revision No. : 00 Issue No. : 00 Date: 21 Nov' 2016

24	Shibl Lubricant, Block no.90, Plot No.1-2-3, Karanj, Modvan Patia, Mandvi, Surat	<a href="mailto:gd19@rediffmail.com">gd19@rediffmail.com</a>	9825263786
25	Shree Bhagwati Petrochem, Plot no. 3, Survey Np. 211, Sihor-Ghanghi Road, Vill. Ghanghli, Ta. Sihor, Bhavnagar	<a href="mailto:himansu_gohil@yahoo.co.in">himansu_gohil@yahoo.co.in</a>	9408209995
26	Suraj barrel supply co., Opp. D.W.D, nr. Goodluck barrel market, chandola lake, narol highway, ahemdabad - 380028	<a href="mailto:suraj_barrel786@yahoo.in">suraj_barrel786@yahoo.in</a>	9825024247
27	Suzlon Enterprise, Plot No.3488/2, Phase-IV, GIDC, Chhatral, Ta-Kalol, Gandhinagar	<a href="mailto:suzlon.enterprise@gmail.com">suzlon.enterprise@gmail.com</a>	9898026614
28	Tawakkal Traders, Plot no-15, jagannath maharaj farm, Ahmedabad	<a href="mailto:tawakkal.traders14@yahoo.com">tawakkal.traders14@yahoo.com</a>	9824032520
29	United Shipping Company, Plot No-69 & 70, Gadhidham, Kutch	<a href="mailto:rajesh@unitedgroupindia.co.in">rajesh@unitedgroupindia.co.in</a>	9898056614
30	Virat Petroleum, Plot No.19 D, Mahagujarat Ind.Estate, Vill moriya, Ta Sanand, Ahmedabad	<a href="mailto:virat.petroleum@gmail.com">virat.petroleum@gmail.com</a>	9824213435
31	Western India Petrochem Ind., Plot No-50, 51, GIDC Estate, Village Gozaria, Dist-Mehsana		9825073658

Section : APPENDICES	Oil Spill Contingency Plan	Page no. 92 of 108
Approved By:	Dahej LNG Port Terminal	Revision No. : 00 Issue No. : 00 Date: 21 Nov' 2016

**A) LIST OF OSR EQUIPMENT AS PER MOU FOR HIRING FACILITY**

<b>Sr. No.</b>	<b>Description of Equipment</b>	<b>Qty</b>
1.	1500 mm Air Inflatable boom on reel with accessories	500 M
2.	750 mm Foam filled boom (Cylindrical) with accessories.	500 M
3.	20 TPH Multi Skimmers system with pumps & power packs	04 Sets
4.	OSD Spray Systems / OSD Applicator	02 Sets
5.	OSD (NIO & CG Approved) Type 2&3	5000 L
6.	10T Flex Barge (Tugs will be utilized with this capacity in lieu of Flexi Barges as per Appendix F2.1 of NOS-DCP 2015)	02 Nos
7.	Absorbent Boom	200 M
8.	Absorbent Pad	1000 nos.

Section : APPENDICES	Oil Spill Contingency Plan	Page no. 93 of 108
Approved By:	Dahej LNG Port Terminal	Revision No. : 00 Issue No. : 00 Date: 21 Nov' 2016



**LIST OF SUGGESTED SHORELINE CLEANUP EQUIPMENTS & MATERIALS**

<b>Sr. No.</b>	<b>Description</b>	<b>Qty</b>
1	PVC Hand Gloves – Small 14”	20
2	PVC Hand Gloves – Small 16”	20
3	PVC Hand Gloves – Small 18”	20
4	Mops with Handle	20
5	Hand Shovel with Wooden Handle	20
6	Wheel Barrow	10
7	Rake with Handle	10
8	Tarpaulin – Standard Size 30 ‘ x 27 ‘	4
9	Gunny Bags	50
10	HDPE Bags	50
11	Safety Helmets	14
12	Liquid Soap ( In Canes)	50 Ltrs.
13	Water Flask 20 Ltrs.	2
14	Saw Dust Packed in Gunny Bags	200 Kgs.
15	Disposable Coveralls – Small	10
16	Disposable Coveralls – Medium	20
17	Disposable Coveralls – Large	20
18	Disposable Coveralls – Extra Large	20
19	Gum Boot - Small	15
20	Gum Boot - Medium	15
21	Gum Boot - Large	15
22	Plastic Buckets – 10 Ltrs	15
23	Plastic Buckets – 20 Ltrs.	15
24	Plastic Mug – 1 Ltrs.	15
25	Cotton Rag – in Bags	200 Kgs.
26	Trolley	3
27	Detergent Powder	50Kgs.
28	Work / Life Vests	6
29	Disposable Cups / Glasses	200
30	Plastic Chairs	6
31	First Aid Kit	1 Set

Section : APPENDICES	Oil Spill Contingency Plan	Page no. 94 of 108
Approved By:	Dahej LNG Port Terminal	Revision No. : 00 Issue No. : 00 Date: 21 Nov' 2016

**INCIDENT ORGANISATION CHART**

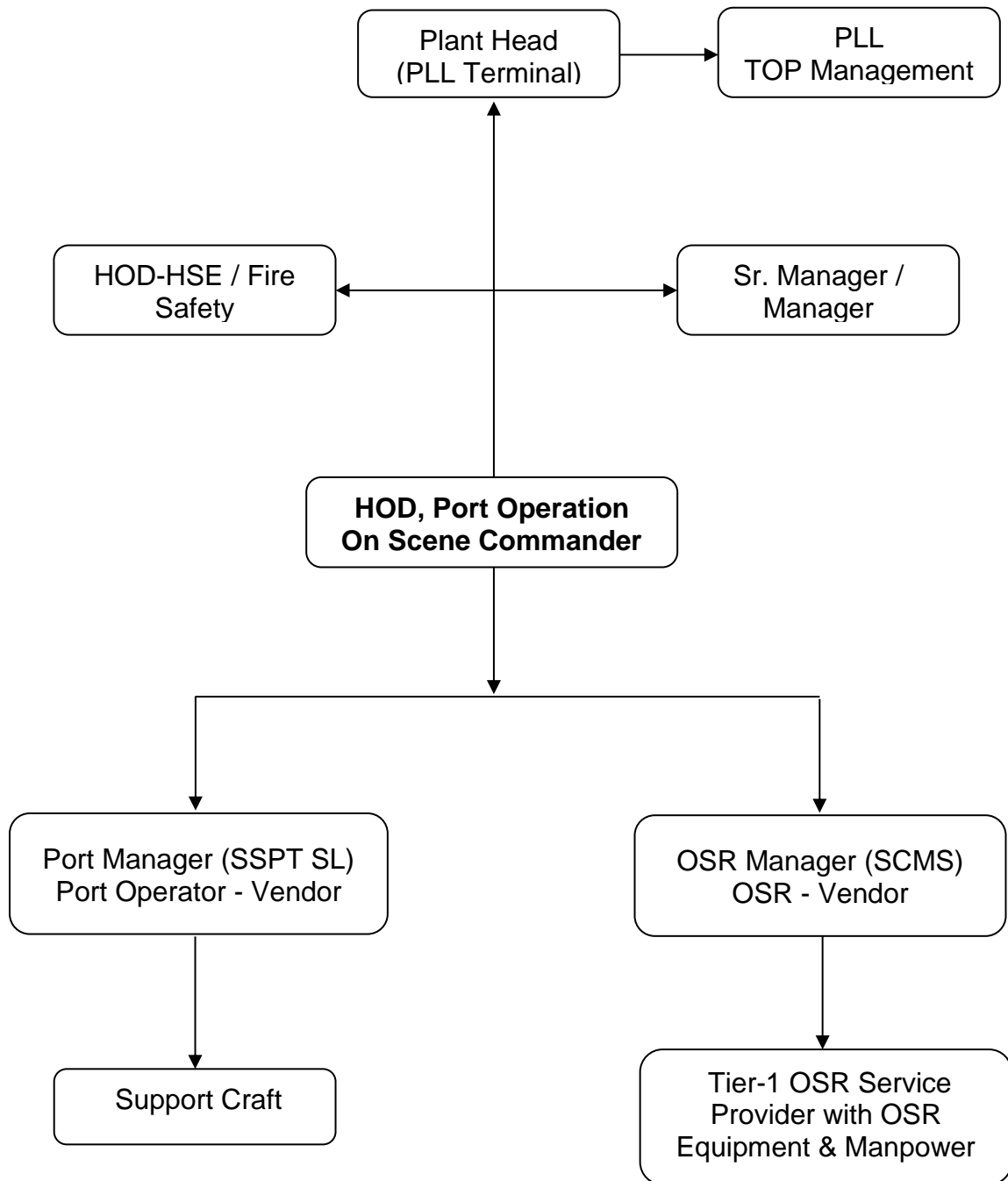

Section : APPENDICES	Oil Spill Contingency Plan	Page no. 95 of 108
Approved By:	Dahej LNG Port Terminal	Revision No. : 00 Issue No. : 00 Date: 21 Nov' 2016

**ADVISOR AND CONSULTANTS LIST**

**A) Advisors:**

Internal Advisors: All the members of the Board of Directors of PLL are requested to be as Advisors.

External Advisors

Indian Coast Guard

**Coast Guard Regional HQ (NW)**

Sector 13A, Sector 13, Gandhinagar,

Gujarat 382013

Tel: 079 2324 1717 / 3136 / 3261, Tel/Fax: 2324 3374

Email: rhq-northwest@indiancoastguard.nic.in

**Coast Guard District HQ – 1**

Porbandar - 360 575

Tel: 0286 224 1794, Fax: 0286 221 0559

**Pollution Response Team (W)**

Shed No. 3, New Ferry Wharf

Mumbai – 400 009

Tel: 022 2372 8867 / 2438

Email: prt\_west@indiancoastguard.nic.in

**Naval Dockyard**

Shahid Bhagat Singh Road

Mumbai – 400 023

Tel: 2275 2066 / 1476 / 2042 / 1583/1334, Fax: 2266 6985; 2266 0394

**Gujarat Pollution Control Board**

Regional Office – Bharuch

Shed No. C - 1/119/3, GIDC Estate

Phase II, Narmadanagar, Bharuch - 392 015

Tel: 02642 246 333, 248 665, Fax: 02642 246 345

Email: [gpcb-bha@gujarat.gov.in](mailto:gpcb-bha@gujarat.gov.in)

Section : APPENDICES	Oil Spill Contingency Plan	Page no. 96 of 108
Approved By:	Dahej LNG Port Terminal	Revision No. : 00 Issue No. : 00 Date: 21 Nov' 2016

**District Collector – Bharuch**

District Collector's Office

Railway Colony, Bharuch

Gujarat – 392 001

Tel: 02642 240 600, 241 500

Emergencies – 02642 242300 / 02642 1077, Fax: 02642 240 602

Email: [collector-bha@gujarat.gov.in](mailto:collector-bha@gujarat.gov.in)

Disaster Office - 2642 242300 / 251900

**DCP – Bharuch**

Tel: 02642 240600, 223633 /223320, Mob: 978406205

Fax 02642 240602,

**B) Consultants****National Institute of Oceanography**

Dona Paula,Goa - 403 004

Tel: 0832 2450 350 / 450, Fax: 0832 2450 602- 4

Email: [ocean@nio.org](mailto:ocean@nio.org)Web: [www.nio.org](http://www.nio.org)**National Environmental Engineering Research Institute**

Nehru Marg, Nagpur, - 440020

Tel: 0712 2249 885 - 88 &amp; 2249 970 - 72

Fax: 0712 2249 900

Email: [info@neeri.res.in](mailto:info@neeri.res.in)Web: [www.neeri.res.in](http://www.neeri.res.in)

Section : APPENDICES	Oil Spill Contingency Plan	Page no. 97 of 108
Approved By:	Dahej LNG Port Terminal	Revision No. : 00 Issue No. : 00 Date: 21 Nov' 2016

**TRAINING AND COMPETENCY**

**PURPOSE**

The HOD, Port Operations, PLL in consultation with the Plant Head as training coordinator shall determine the oil spill training needs and priorities on an annual basis. This will be presented in a matrix form and shall be mandatory

**ATTENDANCE**

All PLL, Dahej Unit's employees shall attend oil spill response awareness training. Personnel having specific roles to play in the plan shall be trained in areas specific to their needs. IMO divides the OSR training in three different levels, as given below

**Level - 1**

To provide field personnel and Supervisor, responsible for undertaking on site cleanup operations, an overview of the techniques available for recovering spilled oil and cleaning polluted shorelines.

**Level - 2**

Supervisor / On-scene Commander / Incident Controller: To provide senior personnel with the skills necessary to co-operate and supervise response operations, in a timely, organised and effective manner.

**Level - 3**

Administrators and Senior Managers: to provide senior personnel with an awareness of the role and responsibilities requires in the management of spills of national signification.

Training courses are required to meet both statutory and PLL, Dahej Unit's requirements for oil spill response preparedness and safe operations.

**RECORDS**

Records demonstrating that personnel have satisfactorily completed the designated training course shall be maintained.

Section : APPENDICES	Oil Spill Contingency Plan	Page no. 98 of 108
Approved By:	Dahej LNG Port Terminal	Revision No. : 00 Issue No. : 00 Date: 21 Nov' 2016

### TRAINING MATRIX:

OIL SPILL TRAINING	IMO OSR Level 1	IMO OSR Level 2	IMO OSR Level 3
Course Description	First Responders	Supervisors/On Scene Commander	Administrators & Senior Managers
ECT members	*		
OSC		*	
ERTs	*		
OSVs - Vessel Crew			
Retraining Frequency	3 years	3 years	3 years

**NOTE:** As per PLL's policy, Total 3 personnel, out of which, 02 personnel for Level-I and 01 personnel for Level-2 will be trained and be a part of their OSR team. The internal training / exercise/ mock drill will be carried out as per given below schedule:

	Duration	Senior Staff	Junior Staff	Frequency	Notes
<b>Exercise</b>					
Notification Exercise	1-2 hours	●	●	6 Monthly	Test communication systems, check availability of personnel, evaluate travel options and the speed at which travel arrangements can be made
Table Top Exercise	2-6 hours	●	●	Annual	Consists of interactive discussions of a simulated scenario among members of a response team but does not involve the mobilisation of personnel or equipment
Incident Management Exercise	6 -8 hours	●		Annual (perhaps in conjunction with other Oil Terminals)	Demonstrate spill response management capabilities, integration of roles of different parties, focus on overall incident management aspects.

Section : APPENDICES	Oil Spill Contingency Plan	Page no. 99 of 108
Approved By:	Dahej LNG Port Terminal	Revision No. : 00 Issue No. : 00 Date: 21 Nov' 2016

**OIL SPILL REPORT FORMS**

**A) INITIAL OIL SPILL REPORT FORM**

Particulars of person, office reporting		
Tel No.		
Date & time of incident		
Spill location		
Likely cause of spill		Witness
Initial response action		By
Any other information		
<p>This FIR is to be sent to Manager/ Officer by fastest means of communication possible. It is an offence not to report oil pollution incident. This FIR is to be followed by company's incident report also.</p> <p>Following POLREP report to the Government through nearest CG information will also be required:</p>		
Identity of informant		
Time of FIR		
Source of spill		
Cause of spill		
Type of spill		
Colour code information (from CG)		
Radius of slick		
Tail		
Volume		
Quantity		
Weather		
Tide / current		
Density		
Layer thickness		
Air / Sea temp.		
Predicted slick movement		
Size of spill classification (Tier 1, 2 or 3)		

Section : APPENDICES	Oil Spill Contingency Plan	Page no. 100 of 108
Approved By:	Dahej LNG Port Terminal	Revision No. : 00 Issue No. : 00 Date: 21 Nov' 2016

## B) OIL SPILL PROGRESS / STATUS REPORT

<b>Incident Name:</b>		
<b>Updated by:</b>		
<b>Date:</b>	<b>Time (local):</b>	
<b>Summary of Incident Response Operations:</b>		
<b>Summary of Incident Response Resource Utilization:</b>		
Number of Aircraft:		Number of Vessels:
Dispersant Used:	Liters	Length of Booms in Use:
Number of Recovery Devices:		Number of Storage Devices:
Sorbent Used:	kg	Bio-remediation Used:
Number of Personnel:		Number of Vehicles:
Specialist Equipment:		
<b>Oil Spill Balance Sheet:</b>		
Total amount of oil spilled:		Tons
Total amount of oil recovered:		Tons
Outstanding amount of spilled oil:		Tons
<b>Mass balance:</b>		
Estimated Natural Weathering:		Tons
Mechanically agitated:		Tons
Chemically dispersed:		Tons
Skimmer recovered:		Tons
Sorbent recovered:		Tons
Manually recovered:		Tons
Bio-remediated:		Tons
Other:		Tons

Section : APPENDICES	Oil Spill Contingency Plan	Page no. 101 of 108
Approved By:	Dahej LNG Port Terminal	Revision No. : 00 Issue No. : 00 Date: 21 Nov' 2016



### C) POLLUTION REPORT (POLREP)

Address

Date

Identification

Serial number

---

Part I	1.	Date
(POLWARN)	2.	Position
	3.	Incident
	4.	Outflow

---

Acknowledge	40	Date and time
		1. Position
		2. Characteristics of pollution
		3. Source and causes of pollution
		4. Wind direction and speed
		5. Tide and current
		6. Sea state and pollution
		7. Drift of pollution
		8. Forecast
		9. Identity of observer and vessel on scene
		10. Action taken
		11. Photographs on samples
		12. Name of agencies informed
		53-59 spare

Acknowledge	80	Date and time
	81	Request for assistance
	82	Coast
	83	Prearrangement for the delivery
	84	Assistance to where and how
	85	Other agencies requested
	86	Changes of command
	87	Exchange of information
	88	Names and number of
	89	Description of equipment
	90	ETA and arrival information
	91	Place of embarkation
	92	Place of disembarking
	93-98	Spare

Acknowledge \_\_\_\_\_

Section : APPENDICES	Oil Spill Contingency Plan	Page no. 102 of 108
Approved By:	Dahej LNG Port Terminal	Revision No. : 00 Issue No. : 00 Date: 21 Nov' 2016

**PERSONAL LOG FORM**  
(To be forwarded to OSC (HOD Port Operation))

Form Completed By :

Name .....

Designation .....

Signed ..... Date ...../...../.....

TIME (24 hour clock)	COMMUNICATION (To / From)	ACTION / MESSAGE

Section : APPENDICES	Oil Spill Contingency Plan	Page no. 103 of 108
Approved By:	Dahej LNG Port Terminal	Revision No. : 00 Issue No. : 00 Date: 21 Nov' 2016

**COMMUNICATION CHANNELS**

1. The following equipment are presently available for communication in operation department or Emergency Control Room.

- VHF sets – Two
- Walkie Talkie Set – Four

Navigational aids with Port

- Tide guage/ current meter: For accurately calculating the height/ direction of tide and current velocity at any given time.
- Complete weather Station : For wind direction, wind speed, Barometer pressure, Wet / Dry temp, of wind
- VTS console integrated with AIS & RADAR.
- Emergency Alarm system to evacuate the jetty area.
- ISPS equipments (i.e Day/ Night vision binoculars, search lights, High beam torch etc)

2. However, in addition to the above the following equipment is felt essential as indicated against each;

A) Walkies Talkie Sets

- OSC 1
- IC 1
- OSR team 1
- Shoreline cleanup Team 1

B) Emergency Control Team (ECT) member can make use of VHF set held with Operation Room while at Administrative office and incase of any member moving out may utilize the spare / standby set.

C) Fax and STD facilities may be utilized from PLL Operation, office with due permission / and justification of sending message to outside agencies.

D) For Emergency Calling, CG

Section : APPENDICES	Oil Spill Contingency Plan	Page no. 104 of 108
Approved By:	Dahej LNG Port Terminal	Revision No. : 00 Issue No. : 00 Date: 21 Nov' 2016

**TELEPHONE DIRECTORY**

<b>SN.</b>	<b>Company</b>	<b>Name and Designation</b>	<b>Telephone / Mob Numbers</b>
1.	PLL Dahej	Plant Head Port operations Head Main Control Room	02641 670299 02641 670291/9662526288 02641 670250/251
2	Sparkle Terminal & Towage Services Ltd	Port Manager	9825311019
3	Gujarat Maritime Board Bharuch	Port Officer	02642-241772/ 09824289398
4	Reliance Dahej Terminal	Terminal Manager Port Control (VHF – 14)	02641 – 282526 02641 - 282531
5	Adani Petronet Dahej Port	Control Room	9687695730
6	Gujarat Chemical Port Ltd. (GCPL)	Port In-Charge Terminal Manager Port Control (VHF – 77)	02641 261023 02641 261004 02641 261017
7	Dahej Harbour & Infrastructure Ltd (DHIL)	Po-In-Charge Terminal Manager Port Control ( VHF – 67)	02641 256004-06 02641 256002/3 Ext 105 02641 662102
8	Coast Guard Station Gandhinagar	Commander (NW)	079 23243184 079 23243183 (Fax)
9	District Headquarters Coast Guard Porbandar	COMDIS –1 Operations Room	0286-2241793, 2214422 0286-2240958 0286-2244056 (Fax)
10	Commander Coast Guard Region West, Mumbai prt_west@indiancoastguard.nic.in	COMCG WEST Regional Operations Officer OP Center Pollution Response Team	022-24379478 022-24376133 022-2437 6133 022-2437 3727 (Fax) 022-2372 2438 / 372 8867
11	CGHQ, New Delhi vprotect@indiancoastguard.nic.in		011 2338 4934 /7237 /4147 /5312 /2414, Fax: 2338 3196
12	Gujarat Maritime Board	Vice Chairman & CEO	079-23238346
13	Ministry of Environment Govt. of Gujarat	Director (Environment)  Under Secretary (In-Charge)	079-23225958 079-23226296 ( Fax ) 079-2325 2657
14	Gujarat Pollution Control Board	Environmental Engineer	079-232 22756 079-232 22784 02642 266233

Section : APPENDICES	Oil Spill Contingency Plan	Page no. 105 of 108
Approved By:	Dahej LNG Port Terminal	Revision No. : 01 Issue No. : 00 Date: 01 Mar' 2022

**MANPOWER DETAILS FOR OSR TEAM**

**AFLOAT - OSR TEAM**

- 1) Team Lead (Port Manager – Vendor) - 1
- 2) Tug master - 1
- 3) Tug's crew - 5

**ASHORE - OSR TEAM**

- 1) Team Leader (OSR Manager – Vendor) - 1
- 2) Workers - 5

Section : APPENDICES	Oil Spill Contingency Plan	Page no. 106 of 108
Approved By:	Dahej LNG Port Terminal	Revision No. : 00 Issue No. : 00 Date: 21 Nov' 2016

**INITIAL PRESS STATEMENT FORM - POLLUTION INCIDENT**

Public Statement Number 1.

*An oil spill* occurred at .....hours today at Off/onshore .....

The location of the incident is nm and nm. from Dahej Port  
 .....

The situation is *under control / not yet under control / out of control*. The vessel involved in the incident / accident is in a stable and safe / unstable and unsafe condition. The Oil spill Response Team in being / has already been mobilized to deal with the situation. So far.....liters / tones of oil has been recovered.

Further statements will be issued in light of any further developments. The news media should contact PRO/ Media coordinator of the PLL, Dahej, Administrative Office for any additional information.

Signature .....

Date .....Time .....

Place: .....

NOTE: When Typed, this Form must be signed by the Emergency Control Team Leader and forwarded to appropriate authority. Under no circumstances the press statement be released to the NEWS Media without the approval of the concerned authority.

Section : APPENDICES	Oil Spill Contingency Plan	Page no. 107 of 108
Approved By:	Dahej LNG Port Terminal	Revision No. : 00 Issue No. : 00 Date: 21 Nov' 2016

**DAILY INCIDENT LOG**

<b>DAILY INCIDENT LOG –TEAM LEADER –OIL SPILL RESPONSE GROUP</b>		
Name..... Rank.....		
Notification received. ONSHORE / OFFSHORE		
Time ..... Date .....		
Day..... Shift.....		
<b>LOCATION OF THE INCIDENT</b>		
Name of the AREA / PLACE.....Area .....		
Latitude ..... Longitude .....		
Distance from Prominent Object .....NM Sounding.....		
-----		
Incident occurred Incident Severity (tick one)		
Time ..... Date ..... Minor / Major/ Tier I/ Tier II/ Tier III		
<b>Brief details of incident and action taken.</b>		
.....		
.....		
.....		
<b>WEATHER DATA</b>		
Wind Speed .....Wind Direction .....Sea State.....		
Current Speed.....Current Direction.....Visibility.....		
Sea Temperature.....Air Temperature ..... Fog / Mist .....		
Rain/Precipitation..... Humidity .....Cloud Cover .....		
<b>OPERATION DATA</b>		
Type of Boom /Booms deployed..... Total Length ..... In Depth .....		
Power Pack Running hrs ..... Skimmer Running hrs .....		
Oil Recovered from water .....Litters/Tons Oil transferred ashore ..... Litters/Tons		
Oil/Sludge cleared from shore .....Kg. Sorbents pads used ..... Nos.		
O.S.D. used .....Litters Saw Dust used..... Kg.		
<b>LOGISTICS AND MANPOWER</b>		
Number and type of vessel/boats available for assistance .....		
Number and type of vehicles available for assistance .....		
Manpower utilized -		
Fireman..... Security Services men ..... Casual Laborers ..... Others .....		
Signature.....		
Time..... Date.....		
On completion, this form is to be handed over to OSC, who would hand over this form to Incident Controller (IC) after his comments and IC would forward it to ECRT leader after his comments.In absence of any OSC/ IC, it may be handed over to ECR Team Leader directly.		

Section : APPENDICES	Oil Spill Contingency Plan	Page no. 108 of 108
Approved By:	Dahej LNG Port Terminal	Revision No. : 00 Issue No. : 00 Date: 21 Nov' 2016

DISTRIBUTION RESTRICTED



NIO/SP-5/2023  
SSP3468

**Marine Biodiversity Impact Assessment Report and Management Plan  
for proposed third berth (jetty) at Dahej**

SPONSORED BY  
**Petronet LNG Limited**

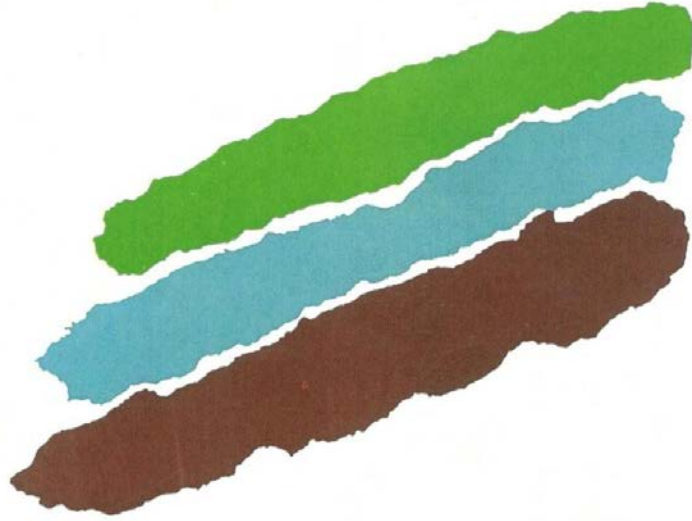
**March 2023**



	<p><b>सीएसआईआर - राष्ट्रीय समुद्र विज्ञान संस्थान</b> <b>CSIR-NATIONAL INSTITUTE OF OCEANOGRAPHY</b> (वैज्ञानिक तथा औद्योगिक अनुसंधान परिषद) (COUNCIL OF SCIENTIFIC &amp; INDUSTRIAL RESEARCH) क्षेत्रीय केंद्र : चार बंगला, अंधेरी (प.) मुंबई- 400 0053. Regional Centre : 4 Bungalows, Andheri (W), Mumbai- 400 053 फ़ोन /Tel : 91(0)22-26359605-08 • फैक्स /Fax: 91(0)22-26364627 (ई-मेल) e-mail: <a href="mailto:rcm@nio.org">rcm@nio.org</a></p> <p><b>HQ: दोना पाउला, गोवा भारत / Dona Paula, Goa – 403 004.</b></p>	
-------------------------------------------------------------------------------------	--------------------------------------------------------------------------------------------------------------------------------------------------------------------------------------------------------------------------------------------------------------------------------------------------------------------------------------------------------------------------------------------------------------------------------------------------------------------------------------------------------------------------------------------------------	---------------------------------------------------------------------------------------



# Marine Biodiversity Impact Assessment Report and Management Plan for proposed third berth (jetty) at Dahej

## Project Leader

Abhay B. Fulke

## Associate Project Leaders

Haridevi C.K.,

Umesh Kumar Pradhan

	<p>सीएसआईआर - राष्ट्रीय समुद्र विज्ञान संस्थान <b>CSIR-NATIONAL INSTITUTE OF OCEANOGRAPHY</b> (वैज्ञानिक तथा औद्योगिक अनुसंधान परिषद) (COUNCIL OF SCIENTIFIC &amp; INDUSTRIAL RESEARCH) क्षेत्रीय केंद्र : चार बंगला, अंधेरी (प.) मुंबई- 400 0053. Regional Centre : 4 Bungalows, Andheri (W), Mumbai- 400 053 फ़ोन /Tel : 91(0)022-26359605-08 • फैक्स /Fax: 91(0)022-26364627 (ई-मेल) e-mail: <a href="mailto:rcm@nio.org">rcm@nio.org</a></p>	
<p>HQ: दोना पाउला, गोवा भारत / Dona Paula, Goa – 403 004.</p>		

March 2023

**CONTENTS**

PROJECT TEAM ..... i

EXECUTIVE SUMMARY ..... ii

LIST OF TABLES..... viii

LIST OF FIGURES..... xi

LIST OF PLATES.....xii

1. INTRODUCTION..... 1

1.1. Background..... 1

1.2. Objectives ..... 2

1.3. Approach Strategy ..... 3

2. PROJECT DESCRIPTION..... 4

2.1. Detailed Project report ..... 4

2.2. Project location ..... 5

2.3. Proposed facilities ..... 7

2.4. Site selection and alternate site details ..... 8

2.5. Project description with process details ..... 9

2.6. Spill Management ..... 11

2.7. Solid and hazardous waste management ..... 11

2.8. Project schedule and cost estimate..... 12

3. STUDIES CONDUCTED..... 13

3.1. Period of study ..... 13

3.2. Sampling location..... 13

3.3. Sampling frequency ..... 14

3.4. Water quality ..... 15

3.5. Flora and fauna .....	19
4. PREVAILING ENVIRONMENT .....	23
4.1. Water quality .....	23
a. Temperature .....	23
b. pH .....	24
c. Salinity .....	24
d. Total Suspended solids (TSS) & Turbidity .....	25
e. DO and BOD .....	26
f. Chemical Oxygen Demand (COD) .....	27
g. Phosphate (PO <sub>4</sub> <sup>3-</sup> -P).....	28
h. Nitrogen Compounds .....	29
4.2. Flora and fauna .....	30
a. Microbiological Aspects.....	31
b. Phytoplankton .....	33
c. Zooplankton .....	37
d. Benthos.....	41
e. Meiofauna .....	42
4.3. Mangroves.....	43
4.4. Fisheries .....	44
4.5. Corals and associated flora and fauna.....	48
4.6. Avifauna .....	48
4.7. Reptiles and mammals.....	48
5. ANTICIPATED MARINE ENVIRONMENTAL IMPACTS AND MITIGATION MEASURES.....	50
5.1. Environmental impacts of construction of berth (jetty).....	50

a.	Berth (jetty) construction and Intertidal area reclamation .....	50
b.	Impact of piling and disposal.....	51
c.	Air pollution from berth (jetty) operations .....	52
d.	Noise and light pollution .....	53
e.	Impact of cargo handling.....	53
f.	Hazardous materials and oil.....	53
g.	Ship and cargo vessel generated wastes.....	54
h.	Introduction of non-native species into the marine environment .....	54
i.	LNG spill .....	54
5.2.	Construction phase impacts on the marine environment .....	55
a.	Water Quality .....	56
b.	Noise.....	56
c.	Impact on Flora and Fauna .....	57
5.3.	Operational phase impacts on the marine environment.....	60
a.	Emissions to atmosphere.....	60
b.	Berth (jetty) related waste .....	61
c.	Ship related wastes.....	61
d.	LNG spill .....	62
5.4.	Mitigation Measures .....	62
a.	Mitigation measures for reducing the impact of piling activities.....	62
b.	General practices followed during the construction phase .....	63
c.	General practices followed during the operational phase.....	64
6.	MARINE BIODIVERSITY MANAGEMENT PLAN (MBMP) .....	67
6.1.	Introduction .....	67
6.2.	Components of Marine Biodiversity and Environment Management Plan.....	68

a. Site-specific Marine Biodiversity Management.....	73
b. Community/stakeholder involvement in conservation activities.....	73
c. Institutional arrangements for marine environmental management .....	74
d. Mechanism for implementation of mitigative measures in the marine segment .....	75
e. Approach towards voluntary compliance.....	75
f. Management sections cover under MARPOL.....	76
g. Legal framework .....	77
6.3. Cost of Marine Environmental Management Plan.....	86
6.4. Marine Environmental Monitoring During Construction and Operational Phase .....	86
6.5. Disaster Management Plan (DMP) .....	89
6.6. Disaster Management Cycle .....	90
6.7. Environmental Sustainability in jetties .....	91
6.8. Environmental performance indicators.....	93
6.9. Policies and regulations .....	94
6.10.General management practices .....	95
6.11.Infrastructure and technologies.....	96
6.12.Planning and optimization .....	96
DISCLOSURE OF CONSULTANTS .....	98
REFERENCES.....	99

**PROJECT TEAM**

Dr. Abhay B. Fulke

Dr. Haridevi CK

Dr. Umesh K. Pradhan

Dr. Soniya Sukumaran (Scientist-in-Charge)

Dr. Rakesh PS

Dr. Sabyasachi Sautya

Mr. Udayakrishnan PB

Mr. Harshal S. Jadhav

Ms. Shrushti Eranezhath

Mr. Balaram Sahu

Mr. Laxmankumar R. Kumbhar

Mr. Balaram Mahanty

Ms. Priyanka Bambaras

Ms. Athira Prasad

Ms. Swathi Ashok

Ms. Salu S. K.

Mr. Satej Pawar

Mr. Venkatesh Saroj

Mr. Mohammed Anas

**SPECIALIZATION**

Biological Oceanography

Biological Oceanography

Chemical Oceanography

Biological Oceanography

Biological Oceanography

Biological Oceanography

Chemical Oceanography

Biological Oceanography

Biological Oceanography

Chemical Oceanography

Chemical Oceanography

Chemical Oceanography

Chemical Oceanography

Biological Oceanography

Biological Oceanography

Biological Oceanography

Biological Oceanography

Biological Oceanography

Biological Oceanography

## **EXECUTIVE SUMMARY**

### **1. Introduction:**

Petronet LNG Limited (PLL) formed on April 2, 1998 as Joint Venture Company having 50% shareholding of leading 4 Oil & Gas PSUs i.e The Oil and Natural Gas Corporation (ONGC), Indian Oil Corporation (IOCL), Bharat Petroleum Corporation (BPCL), and GAIL by GoI order dated July 4, 1997. The Company had set up Southeast Asia's first LNG Receiving and Regasification Terminal with an original nameplate capacity of 5 MMTPA at Dahej, Gujarat which has been in operation since 2004. The infrastructure was developed in the shortest possible time and at a benchmark cost. The capacity of the terminal has been expanded in phases which are currently 17.5 MMTPA. PLL also runs the 5 MMTPA Kochi LNG import terminal in Kerala, which was commissioned in the year 2013. Dahej LNG terminal has 6 LNG storage tanks and regasification facilities. The terminal is meeting around 40% of the total gas demand of the country.

The LNG import terminal is situated in the southernmost part of the Dahej Port region along the Gulf of Khambhat. The Gulf of Khambhat, sometimes called the Gulf of Cambay, is a 200 km long and up to 70 km broad bay on India's Arabian Sea coast. Located around 45 kilometres from Bharuch on Gujarat's south-west coast, Dahej is a prominent freight port.

The terminal has two LNG Jetties at Dahej. While the first jetty can handle berthing of up to Q-Flex vessels, the second jetty can handle berthing of up to Q-Max vessels. The terminal is also offering tolling services to Offtakers & Bulk customers. Considering the increase in demand of Natural Gas in the country and proposed expansion of LNG terminal from 17.5 MMTPA to 25 MMTPA, PLL has now proposed to construct a third

berth (Jetty) adjacent to the existing second jetty for unloading of LNG and transport to the storage tanks. Ministry of Environment, Forest & Climate Change (MOEF&CC) in its Terms of Reference (TOR) has mentioned in their general conditions to prepare a detailed biodiversity impact assessment report and management plan through NIO or any other institute of repute on marine brackish water and freshwater ecology and biodiversity. Thus, PLL had approached CSIR-NIO for carrying out a detailed biodiversity impact assessment report and management plan study.

Considering the requirement of PLL, this report is prepared and is submitted with following objectives.

- a) To establish baseline biodiversity data and assess the impact on study area of proposed developmental site.
- b) To prepare biodiversity management plan to maintain a healthy marine environment near the upcoming jetty.

## **2. Studies conducted:**

The results presented in this report are based on field investigation carried out during October 2022 (post-monsoon). Considering a 10 kilometer radius from the site of jetty construction, 10 locations were sampled including four intertidal zones under this radius. Spot collection was carried out for water quality and biological characteristics study. Intertidal stations were sampled once at each transect in the zone between the Low Tide Line (LTL), Mid Tide Line (MTL) and the High Tide Line (HTL) during post-monsoon season.

## **3. Results**

### **i) Water quality**



The salinity of the marine water around Dahej ranged between 12.2 and 24.6 PSU during the month of October. The water temperature was 27°C and 29.8°C and the range of BOD concentrations was largely between 0.5-4.4mg/L while COD values ranged between 59.1 and 145.3 mg/L. Range of Nitrite ( $\text{NO}_2^-$ -N) was observed between 7.6 and 54.7  $\mu\text{mol/L}$ . These values are lower than that recommended for water criteria for designated best use for salt pans, shell fishing, mariculture and ecologically sensitive zones by the Central Pollution Control Board (CPCB).

## **ii) Biological characteristics:**

The samples showed a low concentration of fecal bacteria which indicates that there might be no disposal of sewage from urban surroundings. The chlorophyll a content of surface water was found to be higher than that of near bottom water indicating good photosynthetic activity. Analysis of the phytoplankton composition reveals that the study area sustains fairly good generic diversity. The study found that zooplankton productivity in terms of biomass and population varied greatly, as is typical for coastal areas subject to tidal influences. IT-II and IT-III transects of intertidal had the highest macrobenthic biomass, population, and faunal diversity when compared to IT-II and IT-IV. The total benthic biomass loss estimated for the development is about 0.786 kg/m<sup>2</sup> and total benthic population loss of  $207996.2 \times 10^4/\text{m}^2$ . In comparison to other intertidal areas, transect IT-III supported a high biomass and population of meiobenthic organisms. This loss would be temporary and the benthos would re-colonize in due course of time, once the activities are terminated and contours are restored after construction activities are over.

## **iii) Mangroves**

Mangrove survey has been carried out by Quadrant method. At the North region (2.2 km) and South region (5.3 km) of proposed jetty, in intertidal area, scattered mangroves are present with the dominance of only one species i.e. *Avicennia marina*. The activities

to be carried out at the proposed third jetty site are confined and there are no mangroves in the proposed site, therefore direct impact on the mangroves is not anticipated.

#### **iv) Fisheries**

The coastal area of Dahej is traditionally not a fishing and gill-netting zone. Major fishing activities like trawling are not noticed in the nearshore water of Dahej. The coastal waters thrive with fisheries resources which are harvested by some local fishermen for their consumption, sustenance and livelihood. Long term impact on fishery is not expected due to proposed project activity although fishing operations by selective fisherman in the region would be hampered during construction period.

#### **v) Avifauna**

The area offers different marine habitats like sandy/muddy intertidal and mangroves for a variety of resident and migratory birds. The birds use these habitats as their active feeding ground especially during low tide. The birds recorded are Gray Heron, Large Egret, Black headed Ibis, Common Sandpiper, Western Yellow Wagtail, Black Drongo, Indian Cormorant, Indian pond Heron, etc. which were commonly seen in the study area.

#### **vi) Reptiles and mammals**

Marine turtles are commonly represented by Loggerhead (*Caretta caretta*) and Olive Ridley (*Lepidochelys olivacea*) along west coast. Other turtles like Hawksbill (*Eretmochelys imbricata*), Leather back (*Dermochelys coriacea*) and green sea turtle (*Chelonia mydas*) are occasionally sighted at the sea coast. The marine mammals are chiefly represented by Dolphin and Porpoise in the coastal waters of Dahej. However, these marine habitats were not sighted at Dahej coast during the field study.

#### **4. Potential Environmental Impacts**

The anticipated environmental impacts due to the activities related to the construction, operation and post operational phases of the proposed jetty project were identified and described in Chapter 5. The major topics covered under this are listed below:

- Environmental impacts of construction of berth (jetty)
- Impact of dredging and disposal
- Air pollution from berth (jetty) operations
- Noise and light pollution
- Impact of cargo handling
- Hazardous materials and oil
- Ship and cargo vessel generated wastes
- LNG spill
- Impact on Flora and Fauna
- Operational phase impacts on the marine environment
- Berth (jetty) related waste
- Ship related wastes

#### **5. Mitigation measures**

A number of management techniques and mitigation measures have been developed globally to reduce the impact of piling and dredging activities on marine and estuarine environments. Detailed mitigation measure connected with each activity were identified and presented in Chapter 5.

#### **6. Environmental Management Plan (EMP)**

Detailed environmental management plan is presented in Chapter 6. The broader plan describes the management measures that need to be taken into consideration during the time of port construction and operation phase. The management plan discusses about

water quality, flora and fauna, navigational aspects, MARPOL 73/78, marine monitoring plan and framework for monitoring, disaster management plan and environmental sustainability practices for the proposed jetty and the associated facilities in Dahej.

## LIST OF TABLES

Table 2.4	Environmental Sensitivity of Project
Table 2.7	Solid/Hazardous Waste Management
Table 3.2.1	Details of subtidal stations
Table 3.2.2	Details of intertidal stations
Table 3.5	Culture media used for various bacterial types
Table 4.1.1	Water quality at different monitoring stations off Dahej during October 2022
Table 4.2.1	Microbial count in surface water at Dahej during October 2022
Table 4.2.2	Range and average (parenthesis) of phytopigments in coastal waters Dahej during October 2022
Table 4.2.3	Range and average (parenthesis) of phytoplankton population at different stations in coastal water of Dahej during October 2022
Table 4.2.4	Percentage composition of phytoplankton population at different stations in coastal waters of Dahej during October 2022
Table. 4.2.5	Range and average (parenthesis) of zooplankton at Dahej during October 2022
Table. 4.2.6	Percentage composition of zooplankton taxa of Dahej during October 2022
Table 4.2.7a	Macrobenthos intertidal standing stock and faunal groups
Table 4.2.7b	Composition (%) of intertidal macrobenthos at Dahej during October 2022
Table 4.2.8a	Macrobenthos subtidal standing stock and faunal groups
Table 4.2.8b	Composition (%) of subtidal macrobenthos at Dahej during October 2022
Table 4.2.9a	Meiofaunal biomass, population and faunal groups at intertidal region
Table 4.2.9b	Percentage composition of benthic meiofauna in the intertidal region

during October 2022

Table 4.2.10a	Meiofaunal biomass, population and faunal groups at subtidal region
Table 4.2.10b	Percentage composition of benthic meiofauna in subtidal region during October 2022
Table 4.3.1	Description of the mangroves near to IT-II
Table 4.3.2	Description of the mangroves near to IT-IV
Table 4.4.1	Taluka-wise fishermen population (as per 2007 survey)
Table 4.4.2	Bharuch marine fishermen data of the Gujarat state
Table 4.4.3	Fishermen vehicle and fish production details (2009-2021) and number of fishing boats in Bharuch district and Gujarat state, 2020-2021
Table 4.4.4	Fish species from Landing Centres, Gujarat.
Table 4.4.5	District and year wise inland fish production in Bharuch district, Gujarat State from 2005-06 to 2020-21
Table 4.4.6	Center wise & species wise marine fish production for the year 2010-11
Table 4.4.7	Center wise & species wise marine fish production for the year 2011-12 (production in kilograms)
Table 4.4.8	Center wise & species wise marine fish production for the year 2012-13 (production in kilograms)
Table 4.4.9	Center wise & species wise marine fish production for the year 2013-14 (production in kilograms)
Table 4.4.10	Center wise & species wise marine fish production for the year 2014-15 (production in kilograms)
Table 4.4.11	Center wise & species wise marine fish production for the year 2015-16 (production in kilograms)
Table 4.4.12	Center wise & species wise marine fish production for the year 2016-17 (production in kilograms)

Table 4.4.13	Center wise & species wise marine fish production for the year 2017-18 (production in kilograms)
Table 4.4.14	Center wise & species wise marine fish production for the year 2018-19 (production in kilograms)
Table 4.4.15	Center wise & species wise marine fish production for the year 2019-2020 (production in kilograms)
Table 4.4.16	Center wise & species wise marine fish production for the year 2020-2021 (production in kilograms)
Table 4.5	List of water birds in the Gulf
Table 4.5.1	List of avifauna observed at Dahej coast during the study period in October 2022
Table 5.2.1	Estimation of Macrobenthos loss
Table 6.2.1	Proposed development activities, associated impacts and mitigation in a nutshell
Table 6.2.2	The existing act/rules and their salient features
Table 6.2.3	Convention to which India is a signatory
Table 6.2.4	A Monitoring Framework

## LIST OF FIGURES

- Figure 1.1 Dahej LNG Terminal
- Figure 2.1 Project boundary map
- Figure 2.2 Location of proposed third berth (jetty)
- Figure 2.3 Layout Plan & Transfer Pipeline Alignment
- Figure 3.2 Sampling location map
- Figure 4.2.1 Distribution of Total Viable Count (TVC) in the surface waters of study area
- Figure 4.2.2 (a) Temporal variation of phytopigments and total phytoplankton density in the water column of station L4 on 18th October 2022
- Figure 4.2.2 (b) Temporal variation of phytopigments and total phytoplankton density in the column of station L5 on 13th October 2022
- Figure 4.2.3 Distribution of phytopigments in the study region
- Figure 4.2.4 Spatial variation of phytoplankton density (average) in the study region
- Figure 4.2.5 Temporal variation of zooplankton biomass, population density and total group at station L5 during on 13th October 2022 in the study region
- Figure 4.2.6 Spatial variation of zooplankton biomass and total population in the study region
- Figure 4.2.7 Percentage composition of zooplankton community in the study region
- Figure 4.4.1 Total production of Hilsa from different centres of Bharuch district



## LIST OF PLATES

- Plate 1      Photographs representing subtidal sampling at Dahej in October, 2022
- Plate 2      View A) to F) of intertidal transect IT-III, project site for proposed LNG Jetty and intertidal Jetty corridor and G) & H) Intertidal sediment collections. Photographs were taken in October 2022
- Plate 3      Photographs of patches of green algae (*Ulva intestinalis*) grown on sand covered rock of intertidal region of Dahej coast in in October, 2022 at intertidal transect ITS-III.
- Plate 4      Mangrove Quadrant method survey from A) to F) at the North region (2.2 km) of proposed jetty in intertidal transect IT-II at Dahej during October 2022.
- Plate 5      Mangrove Quadrant method survey from A) to F) at the South region (5.3 km) of proposed jetty in intertidal transect IT-IV at Dahej during October 2022
- Plate 6      Major phytoplankton genera encountered in Dahej during October 2022
- Plate 7      Zooplankton groups identified from Dahej during October 2022
- Plate 8      Benthic macrofaunal groups identified in the study area in October 2022
- Plate 9      Fishes present around Dahej area in October 2022
- Plate 10     Fisheries survey in market at Baruch, Gujarat during October 2022
- Plate 11     Photographs representing intertidal Biodiversity of A) to C) crabs; D) dead Lady crab; E) & H) Mudskippers observed at Dahej, October 2022
- Plate 12     Avifauna and their intertidal feeding ground and habitat at Dahej in October, 2022

## **1. INTRODUCTION**

### **1.1. Background**

Petronet LNG Ltd (PLL) is an Indian natural gas company formed on the behest of Government of India to import Liquefied Natural gas (LNG) and set up LNG terminals in the country. PLL was formed in 1998 as a joint venture company promoted by the GAIL, ONGC, BPCL and IOCL. It is one of the companies in the Indian energy sector, who has set up the country's first LNG receiving and regasification terminal in Dahej, Gujarat and another terminal in Kochi, Kerala.

PLL owned LNG terminal at Dahej, Gujarat is located at 6 km from Dahej Town in south-west direction in Bharuch District. It commenced its commercial operations in April 2004. Dahej LNG terminal was initially constructed with a capacity of 5MMTPA which was later expanded to 10, 15 and 17.5 MMTPA in three phases. The terminal is meeting around 40% of the total gas demand of the country. At present, two berths (jetties), north jetty (jetty-1) and south jetty (jetty-2), having length of 2.442 km and 2.467 km are operational at Dahej LNG Terminal for unloading of LNG from LNG carrier (ship) and transport to the storage tanks. These jetties are equipped with all allied facilities to unload LNG from ship and transport to the LNG storage tank. Terminal has jetties, trestle and onshore facilities including 6 no. of LNG storage tanks and regasification facilities for 17.5 MMTPA capacity within their battery limit.

Environmental & CRZ Clearance has already been granted to the project by MoEF&CC for handling 20.0 MMTPA LNG.



First Jetty



Second Jetty

Figure 1.1: Dahej LNG Terminal

## 1.2. Objectives

- a) To establish baseline biodiversity data and assess the impact on study area of proposed developmental site.
- b) To prepare biodiversity management plan to maintain a healthy marine environment near the upcoming jetty.

### **1.3. Approach Strategy**

It is necessary to investigate the project site and surrounding locations for a number of marine environmental parameters to establish the baseline biodiversity. In well-planned coastal developments, the probable adverse impacts are identified in advance so that the mitigation measures can be integrated with the design itself. Reliable prediction of impacts on marine biodiversity requires detailed information on water quality and biological characteristics of the area likely to be impacted. Ideally, the field data collection is required to be carried out in detail.

The data of present study and the earlier data available in the CSIR-NIO databank on water quality, sediment quality and biological characteristics will be used to establish the baseline data for proposed development area.

## **2. PROJECT DESCRIPTION**

### **2.1. Detailed Project report**

Dahej LNG terminal was initially constructed with a capacity of 5 MMTPA which was later expanded to 10, 15 and 17.5 MMTPA in three phases. The terminal is meeting around 40% of the total gas demand of the country. At present, two berths (jetties) having length of 2.442 km and 2.467 km are operational at Dahej LNG Terminal for unloading of LNG from LNG carrier (ship) and transport to the storage tanks. The existing marine facilities have two berths (jetties), north jetty (jetty-1) and south jetty (jetty-2) with all allied facilities to unload LNG from ship and transport to the LNG Storage tank.

Considering the increase demand of natural gas in the country and proposed expansion of LNG terminal from 17.5 MMTPA to 25 MMTPA, PLL has now proposed to construct third berth (jetty) adjacent to the existing second jetty for unloading of LNG and transport to the storage tanks. It will also act as risk mitigation measure in case of existing jetties are unable to operate for any extended period or to cater the anticipated number of ships at a time. PLL is also planning to import and unload liquid ethane and propane at the third jetty.

The project is not interlinked with another project. However, it is interlinked with the existing LNG terminal for which environmental clearance is already granted vide letter no. 11-63/2011-IA-III dated 26.02.2014 & extension dated 04.12.2020 for handling 20.0 MMTPA LNG. The proposed project i.e., construction of third jetty falls in Activity 7 (e); Category A as per EIA Notification, 2006 and its subsequent amendments. The onshore infrastructure for liquid ethane and propane storage & regasification system shall be planned and installed at later stage. Ethane and propane unloading shall only be done after construction/installation of onshore ethane and propane Storage & Regasification System.

## 2.2. Project location

The Petronet LNG terminal is located 6 km from Dahej town in south-west direction in Bharuch District. The third berth (jetty) is proposed at a distance of 650 m south of the existing second jetty which will be oriented along north-south direction ( $180^{\circ}\text{N}$ ) similar to the existing jetties considering the current directions. The co-ordinates of the jetty head (point of intersection of berthing line and centerline of unloading platform) is  $23^{\circ}97'642.35$  N and  $24^{\circ}23'19.618$  E. The berth (jetty) will be connected to the shore by an approach trestle. The landfall point of the trestle is proposed at the point of intersection of the existing battery limit wall line and the line between the LNG storage tank T-105 and T-106. The co-ordinates of landfall point are  $23^{\circ}98'348.00$  N and  $24^{\circ}47'50.00$  E. The location of existing & proposed berth (jetty) along with the onshore boundary is shown in Figure 2.1 & 2.2 and Layout is shown in Figure 2.3.



Figure 2.1: Project boundary map



Figure 2.2: Location of Proposed third berth (jetty)

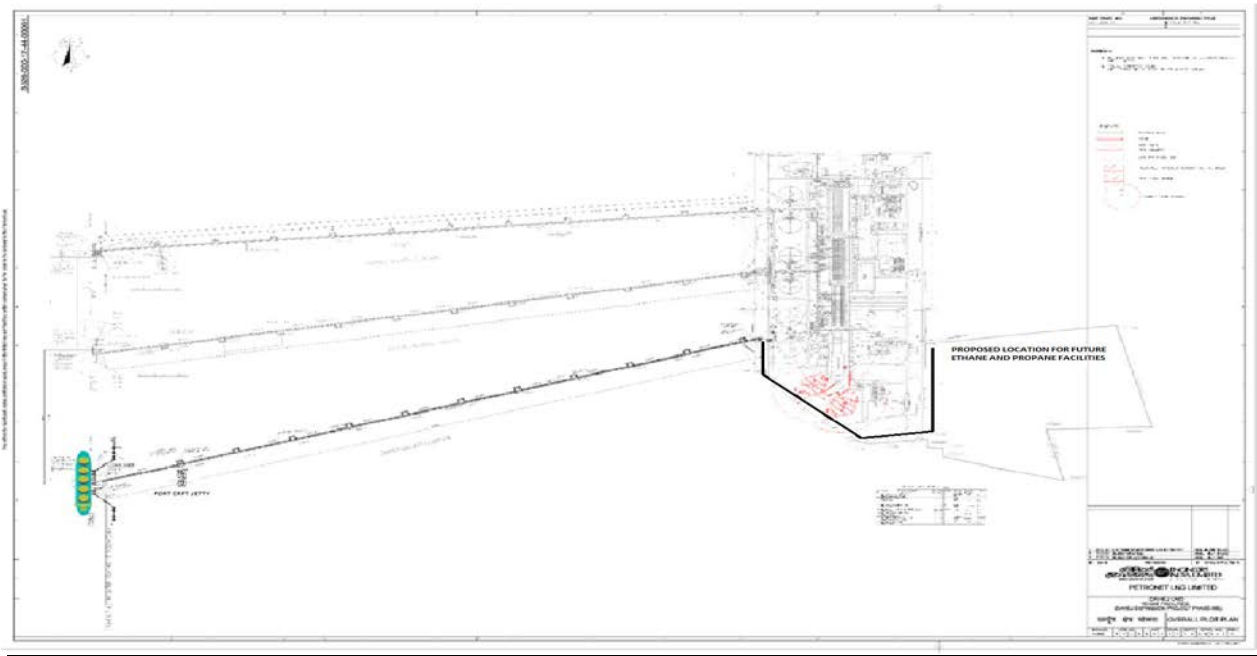

Figure 2.3: Layout Plan & Transfer Pipeline Alignment

### 2.3. Proposed facilities

The jetty will serve as a facility to support the mooring and docking of LNG/ethane & propane carriers and unloading of LNG/ethane & propane from these carriers to the terminal storage tanks. It will be designed to handle vessels ranging from sizes 65,000 m<sup>3</sup> to 2,66,000 m<sup>3</sup>. It will consist of an approach trestle and a berth (jetty). The berth (jetty) will consist of unloading platform, mooring dolphins, berthing dolphins and personnel walkways (catwalk) connecting them. Proposed berth (jetty) will have 4 breasting dolphins (BDs) and 8 mooring dolphins (MDs) for handling of vessels.

The approach trestle with a total length between land fall point and jetty head point is approx. 2.5 km. The proposed berth (jetty) will have:

- LNG/ethane unloading jetty topside with 3 no. 16 X 20" marine unloading arms, 1 vapor return arm (16 X 20")
- 20" line connected to each unloading arm with 36" common header line
- 10" single return gas line for NG
- Two no. 32" LNG unloading lines
- Two no. 20" Liquid Ethane unloading lines
- 8" Vapor Return Line for Ethane
- Two no. 12" unloading arms for propane
- Two no. 20" Propane unloading lines
- Approach trestle to support LNG, ethane and propane, vapor, utilities piping, electrical and instrument cables and conduits.
- A new jetty control room equipped with control panel monitoring the unloading operation
- Firefighting facility at jetty topside
- Fire and gas spill detection/monitoring system
- Vapor return de-superheater and knock out drums
- Sufficient space for double block & bleed isolation arrangement
- Port craft jetty



- Approach road

## 2.4. Site selection and alternate site details

Proposed construction is being linked with existing Petronet LNG Terminal, no alternative site has been considered for the project. Accordingly, site infrastructure and utilities are available. Terminal is well connected with Natural Gas transportation pipeline.

The location of third jetty is proposed in a way that it can be connected to the existing plant boundary which makes integration of utilities likes storage tanks, regasification system with cost effective manner. The geographical proximity of the Terminal with the Dahej Port offers excellent logistic advantage for import of LNG/Ethane and Propane with cost advantage. Existing infrastructure will be used most optimally, resulting in increase of productivity of existing operations as well as reduction of overall cost of new project. Further, the impact on environment will be minimal compared to the project being brownfield project. Environmental sensitivity of the project is mentioned in the below table

Table 2.4: Environmental Sensitivity of Project

Sr. No.	Environmental Features	Within 500 m to 2 km area around Project Site	Within 2-5 km area around Project Site	Within 5-10 km area around Project Site
1.	Ecological Environment			
A.	Presence of Wildlife Sanctuary/National Park/Biosphere Reserves	None	None	None
B.	Reserved/Protected Forests	Lakhigam RF (0.437 km, N)	Dahej RF (2.80 km, N)	None
C.	Wetland of state and national interest	None	None	None

D.	Mangroves	None	2.2 km, N	5.3 km, S
E.	Critically Polluted Area	None within 10 km study area		
2.	Physical Environment			
F.	Road Connectivity	SH-206 (adjacent to site, North)	-	SH-6 (8.3 km, NE)
G.	Rail Connectivity	None	None	None
H.	Defence Installation	None	None	None
I.	Densely Populated Area	-	-	Dahej (5.5 km, NE)
J.	Other villages close to Plant Site	Luvara (0.72 km, E) Lakhigam (1.70 km, NE) Jageshwar (2.6 km, E)		
K.	Seismicity	Zone III (Moderate-Risk Zone)		
L.	Surface Water Resources (Rivers)	Surface Water Resources (Rivers)	-	Ban Khadi (5.53 km, N) Ghughar Khadi (6.53 km N)
3.	Social Environment			
M.	Physical Setting	Industrial, sea, mixed use	Industrial, mix use, sea	Industrial, sea, mixed use

## 2.5. Project description with process details

The proposed project involves unloading of LNG, ethane and propane from ships and transporting the same to storage tanks. LNG, ethane and propane in liquid form is stored in onshore storage tanks and vapourized using LNG vaporizers. There is no change in

the storage and vaporization capacity of LNG Terminal under this project. Additional infrastructure shall be constructed for onshore ethane and propane storage and vaporization at later stage. The vaporized Natural Gas (NG) is sent to the metering station for send out to customers through different cross country NG pipelines.

#### A. LNG UNLOADING

The LNG from the carrier will be unloaded by means of the carrier's on-board pumps. Cool down of the unloading arms and associated auxiliary equipment will be started from the carrier in accordance with the procedure as described by the unloading arms OEM, after which the LNG pumping rate will gradually be ramped-up until the maximum unloading flow rate is obtained. During ship unloading, the NG is supplied through vapour return arm to compensate for displacement in the cargo tanks through vapour return arm. The LNG unloading rate will be controlled from the carrier as agreed with the terminal.

#### B. LNG STORAGE SYSTEM

LNG unloaded from ship is stored in cryogenic 9% Ni stainless steel full containment storage tanks. The tank consists of outer concrete tank and inner 9% Ni stainless steel tank. LNG in tanks is stored at its boiling point i.e.  $-160^{\circ}\text{C}$ . The tank has dedicated safety system for pressure control, liquid level and density measurement. In addition, leak detection system installed in annular space to continuously monitor the insulation space for potential accumulation of LNG.

#### C. LNG SEND-OUT AND VAPORIZATION SYSTEM

The Boil off Gas (BOG) Compressors send the BOG from tanks to re-condenser. LNG from in-tank pumps is send to high pressure (HP) pumps and partial to the re-condenser to re-condense BOG to LNG.

#### D. NG SEND OUT SYSTEM

The NG from vapourizers called Regasified LNG (R-LNG) is sent out through Gas Metering Station to measure the quantity of gas sent out from terminal. The metering station consists of three Metering Runs in which gas flow is measured by ultrasonic flow meters. The measured gas flow is sent out to the customers through pipeline. PLL also have 5 truck loadings bays to dispatch LNG by LNG road tankers.

## E. TYPICAL ETHANE & PROPANE ARRANGEMENT

The unloading of Ethane & Propane will be same as unloading of LNG, except change in pressure, flow, temperature, etc.

### **2.6. Spill Management**

In case of tanker collision or grounding, LNG might spill into the sea. Upon reaching water, the spilled LNG will vaporize rapidly due to the high-water temperature relative to the low boiling point of LNG. As LNG is very buoyant, LNG that leaks below the water will surface and vaporize rapidly. Consequently, LNG spilled into the water will not have a significant impact on the environment. The unloading pipelines at trestle are designed in such a way that the chances of leakages are almost negligible. Proper risk assessments have been carried out for worst case scenarios and adequate control measures are in place to avoid the leakages and timely detection of leakages, if any. The LNG terminal has a comprehensive oil spill contingency plan and equipment for containing oil spill. The plan details actions to be taken and the coordination required to deal with the problem.

### **2.7. Solid and hazardous waste management**

Waste generated from the construction activity shall be disposed as per the C&D Waste Management Rule. Non-recyclable waste shall be reused for construction work and other works. Recyclable waste shall be sold to recyclers. Solid waste will be disposed as per prevailing norms.

There is no continuous source of hazardous waste generation from the terminal. Very minimal waste is generated from different activities. All waste is disposed as per The Hazardous & Other Waste (Management and Transboundary Movement) Amendment Rules, 2021. No additional hazardous waste generation is expected due to the proposed jetty, waste will be limited within the existing permitted quantity. Type, category, quantity and treatment and disposal of hazardous waste is shown in the below.

Table 2.7: Solid/Hazardous Waste Management

Sr. No	Name of Waste	Category	Quantity	Mode of Treatment & Disposal Method
1	Used Oil	5.1	15 KL/Year	Collection, storage, transportation and disposal by selling to registered refiners.
2	Waste Residue containing oil	5.2	9000 KG/year	Collection, storage, transportation and disposal by selling to registered refiners.
3	Industrial use of paint & ink waste	21.1	9000 KG/year	
4	Insulation waste	33.1	9000 KG/year	
5	Empty barrels, containers/liners contaminated with hazardous waste	33.1	4.5 MT/year	Collection, storage, transportation and disposal by sending to approve decontamination facility

## 2.8. Project schedule and cost estimate

Construction will be started after getting all statutory approvals from concerned authority. Construction and operation of the proposed jetty will be completed in 36-40 months after grant of environmental clearance.

Total cost for proposed third Jetty is approx. Rs 1700 Crores.

### 3. STUDIES CONDUCTED

#### 3.1. Period of study

The post-monsoon study of the marine water sample were conducted around Dahej, Gujarat during October 2022.

#### 3.2. Sampling location

Subtidal sampling stations were selected based on the vicinity of 10 km radius and bathymetry to obtain information for the coastal segment likely to be impacted by the proposed project activities. These locations are shown in Figure 3.2.



Figure 3.2: Sampling location map

Table: 3.2.1: Details of subtidal stations

Station Code	Type of Sampling	Latitude (°N)	Longitude (°E)
L1	Spot	21.7501	72.5002
L2	Spot	21.7003	72.5001
L3	Spot	21.7002	72.4496
L4	Spot	21.6624	72.5329
L5	Spot	21.6602	72.5000
L6	Spot	21.6600	72.4499
L7	Spot	21.6200	72.5348
L8	Spot	21.6199	72.4998
L9	Spot	21.6199	72.4499
L10	Spot	21.6602	72.6301

Table: 3.2.2: Details of intertidal stations

Station Code	Type of Sampling	Latitude (°N)	Longitude (°E)
IT-I	LWL, MWL, HWL	21.7072	72.5250
IT-II	LWL, MWL, HWL	21.8734	72.5252
IT-III	LWL, MWL, HWL	21.6644	72.5362
IT-IV	LWL, MWL, HWL	21.6725	72.5796

### 3.3. Sampling frequency

To find out the variation of different parameters, spot collection was done at all stations for water quality and biological characteristics. Intertidal stations were sampled once at each transect in the zone between the Low Tide Line (LTL), Mid Tide Line (MTL) and the High Tide Line (HTL) during this post-monsoon season.

### 3.4. Water quality

#### a) Sampling methodology

Surface water and bottom water samples were collected using Niskin sampler (2.5 L) capacity. Wherever the water depth exceeded 3m surface and the bottom (1m above the bed) samples were collected. For shallow regions, only surface samples were collected.

#### b) Method of analysis

A Niskin water sampler (5L capacity) was used for collecting surface and bottom water samples for general chemical analyses. Only surface sample was collected, whenever the depth was less than 3 m. Majority of the water quality parameters were analyzed within 24 hours of collection in the shore laboratory.

Concentrations of dissolved inorganic nutrients were determined by colorimetric method using a UV-visible spectrophotometer by standard operating procedures for seawater.

**i) Temperature:** Temperature was measured immediately after sample collection using the centigrade mercury thermometer with a graduation of 0-50°C (Precision  $\pm 0.05$ ).

**ii) pH:** pH of water sample was measured onboard using a portable pH meter (Eutech Tutor) with an accuracy of 0.1 pH units. The instrument was first calibrated with standard pH buffers of pH 7.0 and pH 9.0 and then the measurements were made.

**iii) Total Suspended Solid (TSS):** TSS of a known volume of water sample were measured by filtration using filtration pump (Aspirator Vacuum) (Preston and Summers, 1997). Seawater samples were filtered through pre-weighed membrane filter papers (diameter 47 mm; nominal pore size, 0.45  $\mu\text{m}$ ; Make: Millipore) using vacuum pump (Make: Millipore). The filter papers were then dried (45°C) and weighed



again. TSS was calculated from the difference of initial and final weights of the filter paper and expressed as mg/L.

- iv) Turbidity:** Turbidity was determined by nephelometric method using a turbidity meter (Model: Orion AQ4500; Make: Thermo Scientific). The instrument was calibrated with known standards before taking the sample readings.
- v) Salinity:** Salinity was measured onboard using digital probe (Model: Hanna, USA; precision  $\pm 0.1$ PSU) and calibrated with argentometric ( $\text{AgNO}_3$ ) titration method in laboratory. The relative deviation in the data were  $\leq 5\%$ . The IAPSO standard seawater (OSIL, UK) was used in the calibration and standardization of the method.
- vi) DO and BOD:** DO concentration in seawater was estimated by Winkler's method. A known volume of seawater sample was first fixed onboard by adding the Winkler's reagents A (manganous chloride) and B (alkaline potassium iodide) immediately after collection. The precipitate so formed was then decomposed with 50% Hydrochloric Acid (HCl) and the released iodine was titrated against Sodium Thiosulphate ( $\text{Na}_2\text{S}_2\text{O}_3$ ). End point of titration was determined using starch indicator. Concentrations of DO are expressed in mg/L. Samples for the determination of Biochemical Oxygen Demand ( $\text{BOD}_3$ ) were collected in triplicate. The DO concentration was determined first using one of the triplicate samples according to the Winkler's method. The remaining bottles were incubated in BOD incubator for 3 days at  $27^\circ\text{C}$ . DO concentration in these samples were determined by Winkler's method after fixing the samples immediately on completion of 3 days incubation period. The difference in the DO concentrations on the 1<sup>st</sup> and 3<sup>rd</sup> day yielded the measure of  $\text{BOD}_3$  and expressed in mg/L. BOD of the samples having DO  $< 0.3$  mg/L was analysed by seeded method.

**vii) Chemical Oxygen Demand (COD):** The measurement of COD in the studied samples are done using method described in Burns and Marshall, 1965, modified in USEPA 410.3, (1978), after the correction of chloride ion ( $\text{Cl}^-$ ) interference. Briefly variable  $\text{HgSO}_4:\text{Cl}^-$  ratio used for different samples depending up on the  $\text{Cl}^-$  content and to mask the excess  $\text{Cl}^-$ . Mercuric sulfate is added to complex the chloride, and silver sulfate is the oxidation catalyst. The samples are refluxed for 2hr at  $150^\circ\text{C}$  in presence of standard potassium dichromate ( $\text{K}_2\text{Cr}_2\text{O}_7$ ), concentrated  $\text{H}_2\text{SO}_4$  and silver sulphate ( $\text{AgSO}_4$ ). The excess  $\text{K}_2\text{Cr}_2\text{O}_7$  present in digested solution were titrated with standard Ferrous Ammonium Sulphate ( $(\text{NH}_4)_2\text{Fe}(\text{SO}_4)_2 \cdot 6\text{H}_2\text{O}$ ) and oxidizable matter was calculated in terms of oxygen equivalent. The analytical precision achieved in this methodology was less than 10% during this study.

**viii) Phosphate-Phosphorous ( $\text{PO}_4^{3-}\text{-P}$ ):** Dissolved reactive phosphate was measured by the method of Murphy & Riley (1962), modified by Grasshoff et al., 1999, in which the samples were made to react with acidified molybdate reagent and reduced using ascorbic acid. The absorbance of the resultant blue complex was measured at 882 nm using Shimadzu UV mini 1240 spectrophotometer. The instrument performance was evaluated using international seawater standard for nutrient (OSIL, UK)

**ix) Nitrite-Nitrogen ( $\text{NO}_2^-\text{-N}$ ):** Nitrite was determined by the method of Grasshoff et al., 1999 wherein the nitrite in the samples was measured after diazotizing it with sulfanilamide and coupling with N (1-Naphthyl)-ethylene diamine dihydrochloride. The absorbance of the resultant azo dye was measured at 543 nm using a Shimadzu UV mini 1240 spectrophotometer.

**x) Nitrate-Nitrogen ( $\text{NO}_3^-\text{-N}$ ):** Nitrate in the samples was first reduced to nitrite by passing each through an amalgamated cadmium reduction column and the resultant nitrite was determined as above. The measured absorbance was due to the initial

nitrite in the sample and the nitrite obtained after the reduction of nitrate. Necessary correction was therefore made for any nitrite initially present in the sample.

**xi) Ammonia-Nitrogen ( $\text{NH}_4^+\text{-N}$ ):** Ammonia-nitrogen was determined by the Indophenol blue method based on the principle that in a moderately alkaline medium, ammonia was allowed to react with hypochlorite in the presence of catalytic amounts of nitroprusside to form indophenol blue. The formation of monochloramine requires a pH between 8 and 11.5. The resultant blue complex was measured at 630 nm by spectrophotometer.

### **3.5. Flora and fauna**

#### **a) Sampling procedure**

For microbiological analysis, surface water was collected in sterilized PP bottle using Niskin water sampler. For the estimation of phytopigments and phytoplankton population (cell count) Niskin water sampler was used and water sample from surface and bottom waters were collected. Samples for enumeration of phytoplankton cell count were fixed with Lugol's iodine on onboard and samples for phytopigments were kept in ice box and transported to lab.

Zooplankton were collected by oblique hauls using Heron Tranter net (mesh size = 0.20 mm, mouth area = 0.25 m<sup>2</sup>) attached with a calibrated flow meter. All collections were of 5 minutes duration. Samples were preserved in 5% buffered formaldehyde.

Sediment samples for subtidal macrobenthos and meiobenthos were collected using a van Veen grab having area of 0.04 m<sup>2</sup>. Samples were preserved in 5% buffered formaldehyde-Rose Bengal solution.

#### **b) Method of analyses**

##### **i) Microbiology:**

The enumeration of Total Viable Count (TVC), Escherichia coli like organisms (ECLO) and Streptococcus faecalis like organisms (SFLO) was carried out by spread plate method. Other parameter such as Total Coliforms (TC) and Fecal Coliforms (FC) number were determined using a conventional three-tube, three-dilution most probable number (MPN) procedure with minimal modifications to the FDA Bacteriological Analytical Manual (BAM) and American Public Health Association (APHA 1970, Patra, P., et al, 2021) recommended procedures for the examination of water samples. The sample was transferred to the three tubes of 10 ml of double strength lauryl tryptose broth (LTB). One milliliter aliquot was also transferred to the three tubes of single strength LTB, while three

1-ml aliquots of a 1:100 dilution were also transferred to the single strength LTB and incubated and observed for turbidity and gas production. These initial presumptive positive tubes were confirmed for fecal coliforms and total coliforms by using EC Medium broth and Brilliant Green Bile broth respectively. Results are reported in MPN/100ml for the water samples.

Table 3.5: Culture media used for various bacterial types

Serial no	Bacterial type	Culture medium
1	Total Viable Counts	Zobell marine agar
2	Total coliforms(TC) (MPN method)	Lauryl Tryptose Broth Brilliant Green Bile Broth
3	Fecal coliforms(FC) (MPN method)	Lauryl Tryptose Broth EC Broth
4	<i>Escherichia coli</i> (ECLO)	M <sub>7</sub> HrFC Agar
5	<i>Streptococcus fecalis</i> (SFLO)	M Enterococcus Agar

All of the media plates, were incubated at 37°C ± 1°C for 24-48 hrs, and final counts of colonies were noted. The number of colonies counted on the plate is taken to be equivalent to the number of bacterial cells present per volume of the sample filtered. The MPN tubes were checked for gas production and turbidity.

## ii) Phytoplankton:

**Phytopigments:** A known volume of water sample (500 ml) was filtered through Whatman GF/F Glass Fiber filter paper (47 mm diameter; nominal pore size, 0.7 µm) and the pigments retained on the filter paper were extracted in 90% acetone overnight at 5°C. The extracts were used for the estimation of chlorophyll *a* and phaeophytin. The fluorescence of the acetone extract was measured using Fluorometer (Turner Design Trilogy) before and after treatment with dilute acid (0.1N HCL). The concentration of

phytopigments (chlorophyll *a* and pheophytin) is reported as  $\text{mg m}^{-3}$  (Parsons et al. 1984).

**Phytoplankton population:** A known volume of 500 ml of sample was preserved with Lugol's solution and allowed to settle and concentrated to 100 ml. 1 ml of the concentrate sample was transferred into a Sedgewick-Rafter slide for the enumeration and identification of phytoplankton and were identified and counted under an inverted microscope (Olympus IX51 Japan, of magnification 400x) to the lowest taxa using standard manuals of Diatoms, Dinoflagellates and Blue green algae (Tomas 1997; Subrahmanyam, 1946; UNESCO, 1978). The phytoplankton population density is reported as no.  $\times 10^3$  Cells/l.

### iii) Zooplankton:

Zooplankton samples were collected from surface waters by horizontally towing a Heron-Tranter net (mesh size, 200  $\mu\text{m}$ ) attached with a calibrated digital flow meter (General Oceanics, USA) at the mouth to record the value of water. After the haul (5 minutes), the net was carefully washed with seawater and the samples were collected in a plastic bottle. The samples were then preserved in 4% buffered formalin prepared in seawater for further analysis in the laboratory. Zooplankton biomass was estimated by displacement volume method and expressed as  $\text{ml}/100\text{m}^3$  (ICES, Zooplankton Methodology, 2000) and the concentrated samples were diluted to an aliquot of 6.25% using a Folsom plankton splitter and were then examined under the stereoscopic binocular microscope for numerical counts and group identification.

### iv) Benthos:

The sediment was sieved through a 0.5 mm mesh sieve and macrobenthos retained were stained with the Rose Bengal and preserved in 5% buffered formaldehyde. Total population was estimated as number of animals in 1  $\text{m}^2$  area and biomass on wet weight basis ( $\text{g}/\text{m}^2$ ).

The meiobenthic organisms were collected using syringe suction were stained with the Rose Bengal and preserved in 5% buffered formaldehyde. Total population was estimated as number of animals ind./10cm<sup>2</sup>.

**v) Mangroves**

Mangroves survey was carried out around the region of study. Distribution studies were carried out using quadrat sampling method in 10×10 m<sup>2</sup> area around the north and south of the jetty. Total 3 quadrats were taken at the proposed study site.

**vi) Fisheries:**

Fish landing data were obtained from the Department of Fisheries, Government of Gujarat, for assessing the fishery status of the region.

**vii) Avifauna**

A list of varieties of migratory and resident birds inhabiting the Dahej coast was prepared and presented based on survey and available literature for Dahej and Gulf of Khambhat area.

**viii) Reptiles and mammals**

Marine reptiles and mammals noticed along Dahej coast were obtained from published information for the study area.

## 4. PREVAILING ENVIRONMENT

### 4.1. Water quality

The overall water quality off Dahej, Gujarat, is the result of a balance between the anthropogenic fluxes of pollutants from domestic and industrial sources vs. the removal of contaminants by natural processes. The results of measured chemical parameters at different depths during the present study are presented in Table 4.1.1. For convenience, the water column averages are depicted in the figures and discussed.

#### a. Temperature

Water column temperature during Oct-2022 around Dahej waters ranged between 27°C and 29.8°C, averaging at 28.4°C (Table 4.1.1). The air temperature during the sampling varied from 27 to 33°C and averaged 29.7°C. The trend of water temperature variation remains more or less comparable with air temperature, as indicated in the figure below.

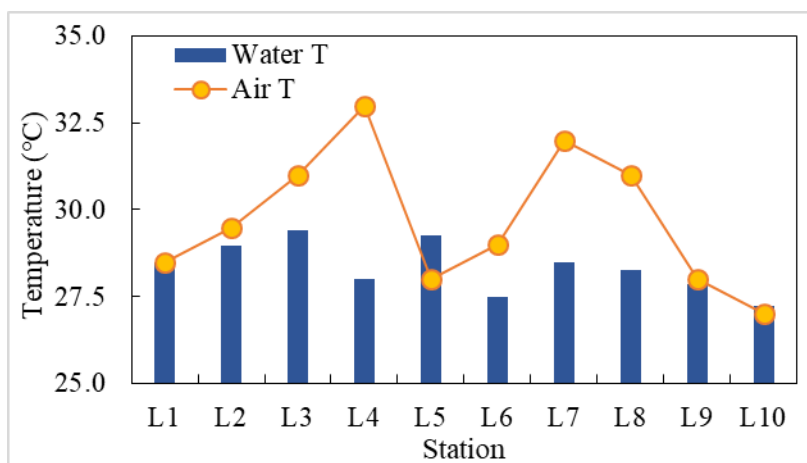

Generally, the temperature variation between the surface and bottom water column was minimum in estuarine and coastal stations. The average water column temperature was highest at L3, followed by L5, compared to other stations during the sampling. The



temperature remains lower than the general temperature (35.5°C) for tropical aquatic organisms.

**b. pH**

pH around the study region varies within a narrow range between 7.7 and 8, averaging at 7.8 during October 2022. The surface bottom variation of pH was minimum among all the sampling stations. The water column averages were comparable among the sampling stations, except at few stations (L2, L4, L6, and L7), which show slightly lower ( $\leq 0.5$  pH unit) values during this study, as indicated in the figure below.

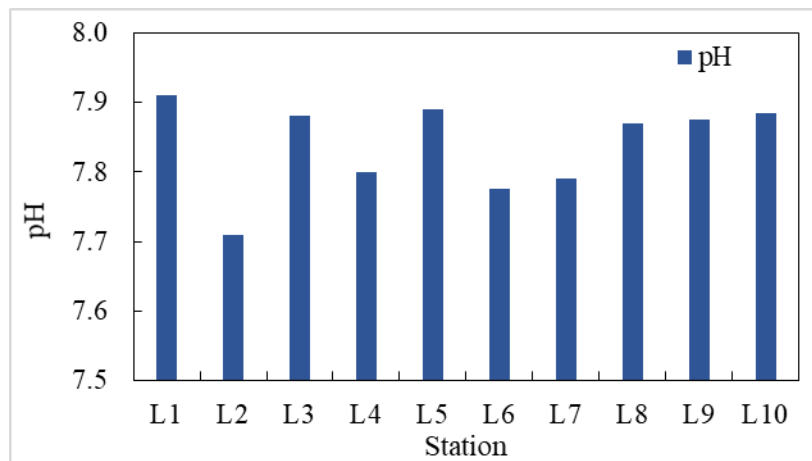

Overall, there was no noticeable pH variation in the region during Oct-2022, and the pH was within the limit prescribed for India's coastal waters.

**c. Salinity**

Salinity around the study region broadly ranged between 12.2 and 24.6 PSU (av. 20.4 PSU), with higher bottom values than the surface in most stations (Table 4.1.1). The stations L5 and L10 showed similar salinity in their surface and bottom waters, indicating strong mixing, concurring with similar surface and bottom temperature values. The

average water column salinity distribution indicated the lowest salinity at L4 and the highest at L9, as shown in the figure below. The low salinity at the L4 is the surface water, which generally has lower values than the bottom in most coastal stations (Table 4.1.1).

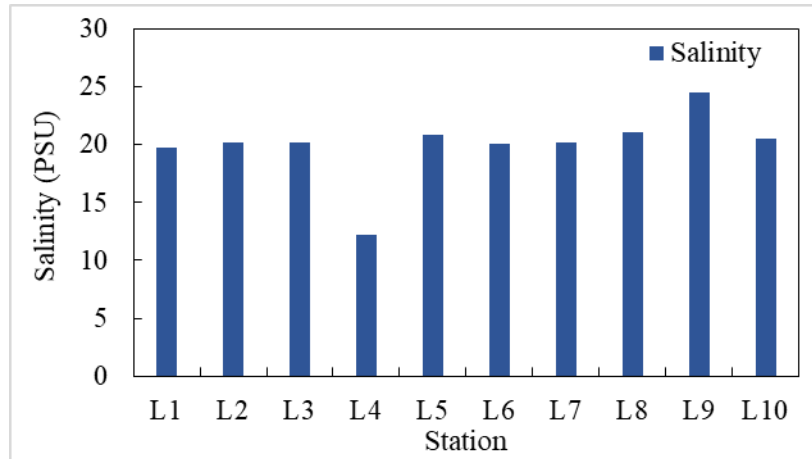

**d. Total Suspended solids (TSS) & Turbidity**

The TSS around the study region during the study broadly ranged between 27 mg/L and 7915 mg/L, averaging at 1106 mg/L (Table 4.1.1). The TSS in the bottom water was 5-18 times higher than the surface. The stations L3 and L6 in the offshore region showed minimum TSS difference between the surface and bottom. The higher TSS difference between the surface and bottom is likely due to high tidal current action in the region. Likewise, the turbidity values of TSS ranged between 4 and 7110 NTU, averaging at 1106 NTU during Dec-2022. The variation of water column turbidity was in line with the TSS variation. The lowest turbidity was at L3 and L6, similar to TSS.

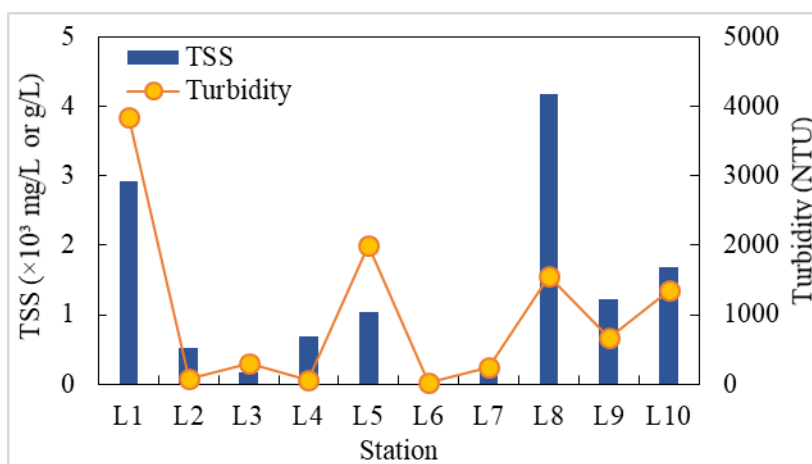

During this study, the TSS levels at the coastal waters off Dahej are exceptionally higher at the bottom compared to the general TSS (<100 mg/L) prescribed for the inland surface water and coastal marine waters around India. The elevated levels of TSS and turbidity in the bottom were possibly due to the strong water current in the gulf. The higher surface values are affected by the tidal circulation and riverine input.

#### e. DO and BOD

The water column DO within the study area ranged between 4.2 and 8.2 mg/L, averaging 6.8 mg/L. Similarly, the BOD values ranged from 0.5-4.4 mg/L (av. 2.2 mg/L). The surface bottom DO variation was insignificant in most stations, indicating a well-mixed water column. Moreover, the DO was more than 5 mg/L throughout all stations except at the bottom of L3. The DO values have indicated toxic water presence in the region. The water column average DO at the sampling stations is presented below. The BOD variation between the surface and bottom was minimal (<1 mg/L) except at L8 (mouth of Narmada) and L10 (estuary), where bottom values were higher than the surface.

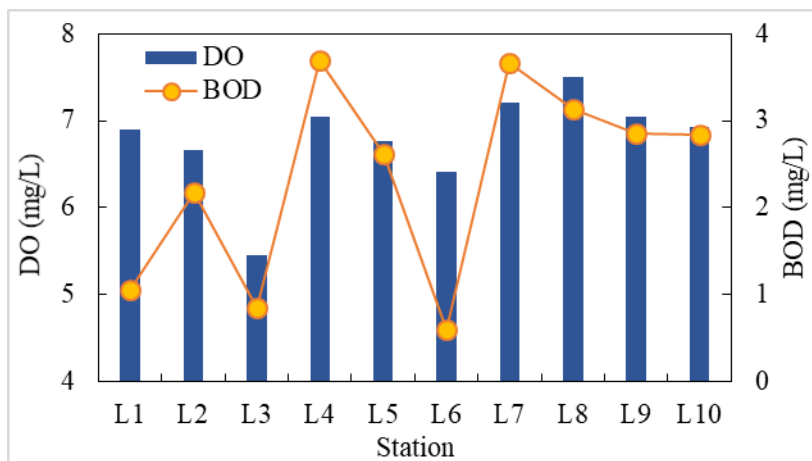

Overall, the BOD values were randomly varied among the stations in the coastal and offshore regions. Higher BOD values coincide with higher DO (>5 mg/L), indicating the absence of organic matter oxidation.

#### f. Chemical Oxygen Demand (COD)

The COD values around the study area ranged between 59.1 and 145.3 mg/L (av. 104.4 mg/L). The surface and bottom variation of COD was random during this study. Overall, the COD values were less than the limit generally prescribed for coastal marine waters in India. The water column COD distribution among the stations is presented in the below figure, which indicated the lowest values at stations L7 and L8, i.e., at the mouth of the Narmada estuary, possibly related to the dilution. The highest COD value was at station L5 during this study.

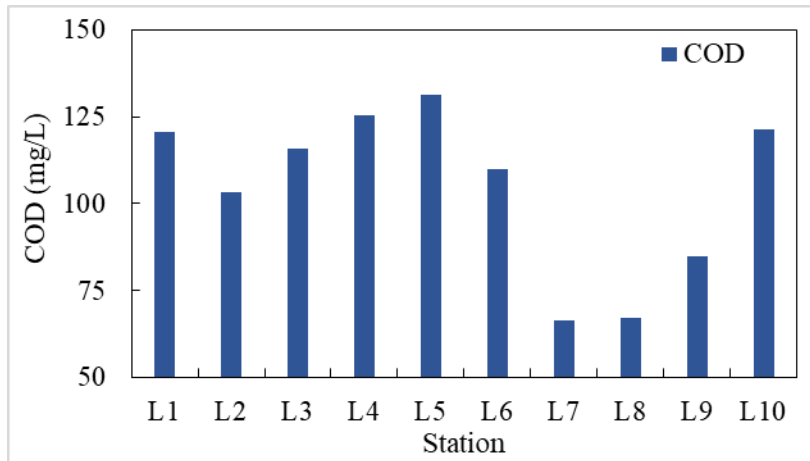

**g. Phosphate ( $\text{PO}_4^{3-}\text{-P}$ )**

Phosphate ( $\text{PO}_4^{3-}\text{-P}$ ) around the study region varied between 1.3 and 2.6  $\mu\text{mol/L}$  (av. 1.9  $\mu\text{mol/L}$ ), with nearly similar values between surface and bottom water (Table 4.1.1). The average phosphate of the water column was more or less similar in the entire region, except roughly a unit lower at L7, possibly due to the effect of river water dilution, indicated in the figure below.

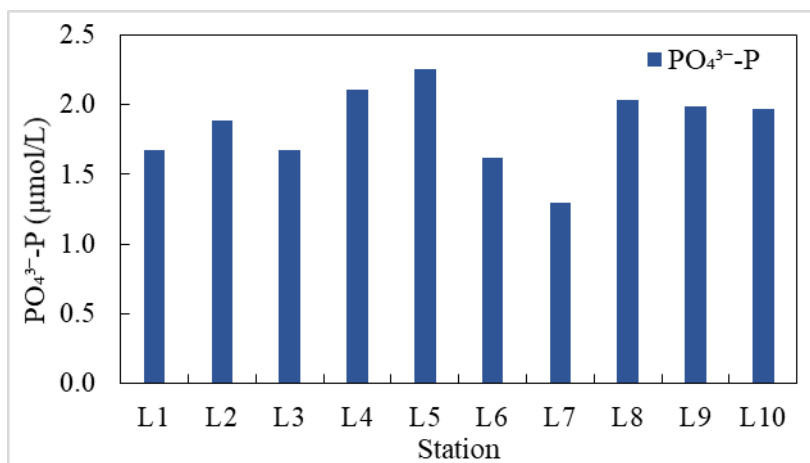

The limits of  $\text{PO}_4^{3-}\text{-P}$  found in this study are much lower than the limit prescribed for phosphate in inland waters and do not indicate any build-up of phosphorous in the region.

## h. Nitrogen Compounds

Nitrate ( $\text{NO}_3^-$ -N) around the study region varied widely between 7.6 and 54.7  $\mu\text{mol/L}$  (av. 34.9  $\mu\text{mol/L}$ ) (Table 4.1.1), with generally higher values on the surface than the bottom. Likewise, nitrite ( $\text{NO}_2^-$ -N) concentrations were low, varying between <0.1 and 0.5  $\mu\text{mol/L}$  (av. 0.2  $\mu\text{mol/L}$ ) in the region, with the minimum difference between surface and bottom.

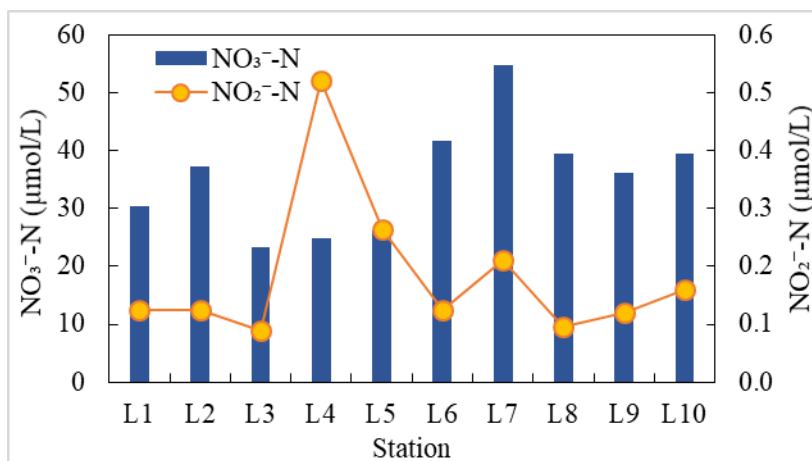

The water column nitrate averages varied randomly among the stations, with higher values at L7. Low nitrate at L4 somewhat coincides with high nitrite, indicative of nitrification.

The ammonium values ranged from 0.2 to 7.4  $\mu\text{mol/L}$  (av. 3.4  $\mu\text{mol/L}$ ), indicating the second dominant nitrogen form after nitrate in the region. The surface ammonium values were more or less high than the bottom at most of the stations of this study, except that at L3, which showed higher ammonium in the bottom. The station-wise water column ammonium is presented in the figure below, which indicated lower values along the Narmada estuary, possibly due to the effect of dilution. The slightly elevated ammonium levels at L1 and L4 possibly relate to localized activities.

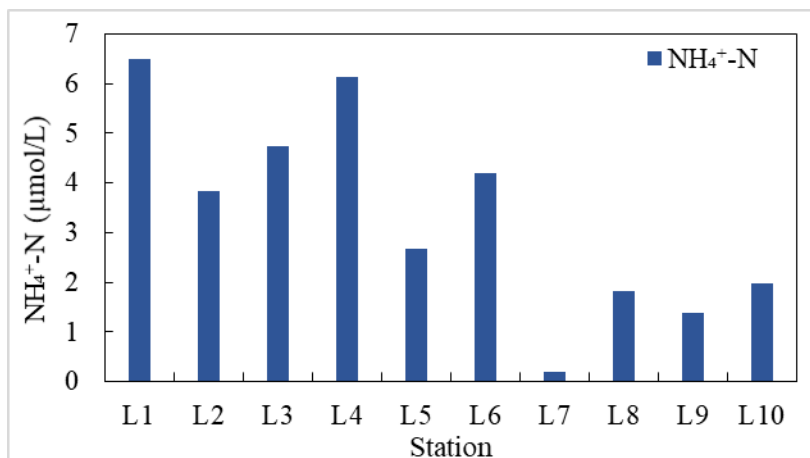

## 4.2. Flora and fauna

Whenever we consider assessment of aquatic pollution implications, we must be aware of the fact that, despite many changes it may cause in the physico-chemical properties of a water body and bed sediment, the ultimate consequences are inevitably of a biological nature. Hence, the investigations of ecosystem and particularly of their community structure constitute an important part of any marine assessment study.

The basic process in an aquatic ecosystem is the production of organic carbon by photosynthesis. The transfer of energy from the primary source through a series of organisms is defined as the food chains which are of two types: the pelagic food chain and the detritus food chain. Stress may cause the floral and faunal communities to exhibit low biomass and high metabolism. In addition, due to depressed functions of less tolerant predators, there may also be a significant increase of dead organic matter deposited in sediments of modified ecosystems under stress. Depending upon the type, strength and extent of a stress factor, the ecosystem will either react to it or re-establish the previous equilibrium or establish a new one, or it may remain in prolonged disequilibrium.

The biological parameters considered for the present study are microbiological diversity, phytoplankton pigments (Phytopigments: Chlorophyll a and Pheophytin) and phytoplankton population (cell count), zooplankton biomass and population, macro and meio-benthic biomass and population, mangrove and fishery status. The first three reflect the productivity of a water column at the primary and secondary levels (Pelagic food chain). Benthic organisms, being sedentary animals associated with the bed, provide information on the integrated effects of stress, if any, and hence are good indicators of early warning of potential damage (Detritus food chain). Fishery status through data provided by the Gujarat Fisheries Department provides information on the fish composition and hence commercial potential of water body. A collective evaluation of all the above components is a reliable approach to predict the state of equilibrium of aquatic life in the present marine system.

#### **a. Microbiological Aspects**

Microbial ecology is on the forefront of developing and applying a new generation of indicators of environmental stress and ecological change. The roles played by marine microorganisms are profound in the overall normal functioning, stability and continuance of the marine ecological processes. Despite their small size marine microorganisms are far more important as they are linked to water column and sediment (benthic) processes. Marine microorganisms occupy the base of the food web, and form food for protozoa, invertebrate larvae and many large zooplankton and regenerate dissolved nutrients for marine photosynthesis and formation of newer organic biomass. Bacteria are major links to many biological and non-biological events in the oceans. As we learn about the diversity of microorganisms and their associated processes, our view of the marine ecosystem is being transformed, and the relevance of microbes to marine resiliency and marine resource management is becoming undeniable. The sheer number of microorganisms act as sentinels for health status within marine ecosystem as well as their vast diversity and different functions has led to the realization of threats from



emerging pathogens. In order to bring into focus the importance of marine bacteria at base of the food web, an assessment of their abundance and distribution are essential. The microbial diversity of coastal waters can be influenced by anthropogenic activities also besides oceanic processes.

The principal source of waterborne diseases such as cholera, typhoid and hepatitis is due to contamination of water by sewage and animal wastes. Apart from potable water, bacterial contamination occurs in surface waters such as those used for shell fishing areas, beaches, fisheries and recreational facilities. Though 90% of the intestinal bacterial population dies off within 2 days in natural waters, the remaining 10% decline much more slowly. Coliform bacteria such as *Escherichia coli* and Faecal streptococci (Genus: *Streptococcus*) are the two most important groups of non-pathogenic bacteria found in sewage. Because of number of problems associated with the determination of populations of individual pathogens, non-pathogenic bacteria (such as coliforms) are used as indicators of water pollution. Untreated domestic waste-water has about 3 million coliforms/100 ml. Because pathogens originate from the same source, the presence of high numbers of coliforms indicates potential danger. Bacteriological analyses for present study included the enumeration of total viable bacterial counts (TVC) and coliforms at 10 stations in coastal waters off Dahej, in Gulf of Khambat. Total Viable Counts (TVC), Total Coliform (TC), *Escherichia coli* like organisms (ECLO) and *Streptococcus faecalis* like organism (SFLO) were studied.

The total viable bacterial populations in the water samples ranged widely from  $12 \times 10^3$  CFU/ml to as high as  $28 \times 10^3$  CFU/ml (Figure 4.2.1). The lowest counts were recorded at station L2, L6 and L9 and highest counts were recorded at station L4 and L5. Other parameters like Total Coliform (TC), Fecal Coliform (FC) and *Escherichia coli* like organisms (ECLO) were also checked. *Streptococcus fecalis* like Organism (SFLO) was absent at most stations except L3, L4 and L5 (Table 4.2.1). From the enumeration of

bacterial counts, it is inferable that the populations of different bacteria are in the general ranges reported in coastal waters that experience low anthropogenic impacts.

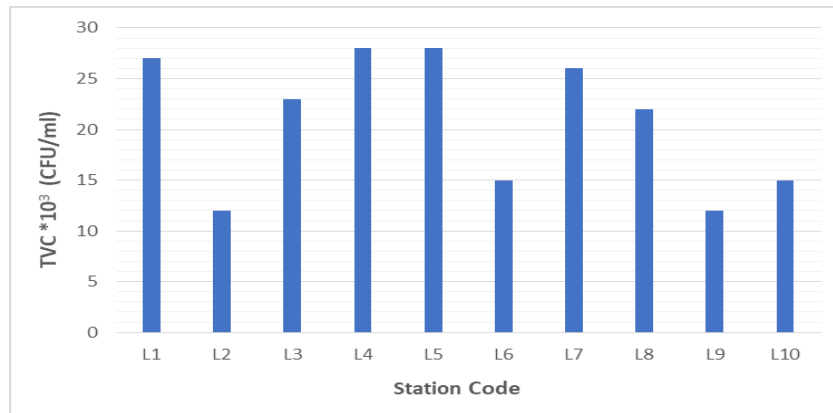

Figure 4.2.1: Distribution of Total Viable Count (TVC) in the surface waters of study area

Water quality criteria set by the Central Pollution Control Board (CPCB), specifies that the counts (Most Probable Number (MPN)) of FC to be  $\leq 100$  MPN/100 ml for SW-II waters. On comparing the results obtained for microbiological quality in water at studied locations with the standard laid by CPCB for primary water quality criteria for sea waters, it was found that the counts of fecal coliforms in the stations were less indicating that the study area has a very low fecal pollution (Table 4.2.1).

## b. Phytoplankton

Phytoplankton being primary producers plays a major role in synthesizing organic carbon using inorganic nutrients, carbon dioxide and sunlight in the marine environment. Hence, they are the basic component of food chain and play an important role in the ecological assessment of the marine ecosystem.

A normal ecosystem with a natural balance between different trophic levels viz. primary, secondary and tertiary productions gets disturbed and imbalanced of its food chain due to anthropogenic pollutants. An ecosystem receiving domestic wastewaters

could lead to an unwanted algal proliferation or bloom associated with alteration in community structure of phytoplankton.

**a) Phytopigments:**

Phytoplankton biomass was evaluated in terms of phytopigments (Chlorophyll *a* and Pheophytin). Phytopigments are considered as water quality index. Chlorophyll *a* is the photosynthetic pigment of any phytoplankton and pheophytin is the degraded form of chlorophyll *a*. To assess the health condition of a phytoplankton, Chlorophyll *a*: Pheophytin ratio is calculated. If the ratio is  $>1$  then it is said that the phytoplankton is not under stress, on the other hand if the ratio is  $<1$  it is considered to be under stress. The stress can be due to any kind of environmental variables like temperature, salinity and nutrients limitations (N, P and Si) that can affect the growth of phytoplankton.

Chlorophyll *a* in the study region ranged from 0.1 to 2.72 mg/m<sup>3</sup> (av. 0.43 mg/m<sup>3</sup>). It was observed that surface water chlorophyll *a* was relatively higher than the near bottom water. Pheophytin which is the degraded form of chlorophyll *a* ranged between 0.01mg/m<sup>3</sup> and 3.44 mg/m<sup>3</sup> during the study period (Table 4.2.2).

Temporal variation of phytopigments, pheophytin and phytoplankton density at station L4 is given in (Figure 4.2.2a) below. Temporal variation of phytopigments at station L4 indicated that the chlorophyll *a* concentration was almost the same from flood to ebb period. Similarly in the case of pheophytin which did not show any noticeable variation from flood to ebb.

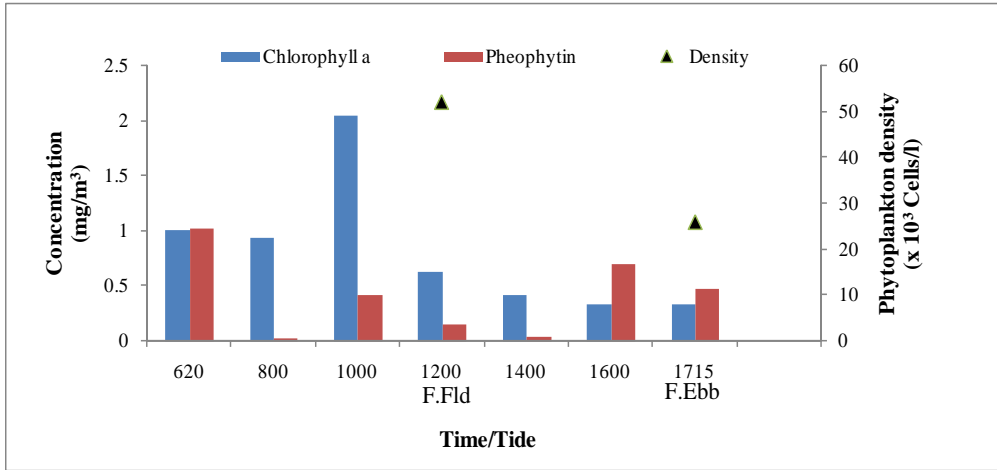

Figure 4.2.2 (a): Temporal variation of phytopigments and total phytoplankton density in the water column of station L4 on 18th October 2022

Temporal variation of phytopigments, pheophytin and phytoplankton density at station L5 is given in (Figure 4.2.2b) below. Temporal variation of phytopigments at station L5 indicated that the chlorophyll a concentration was high during ebb period compared to flood period, similarly in the case of pheophytin too.

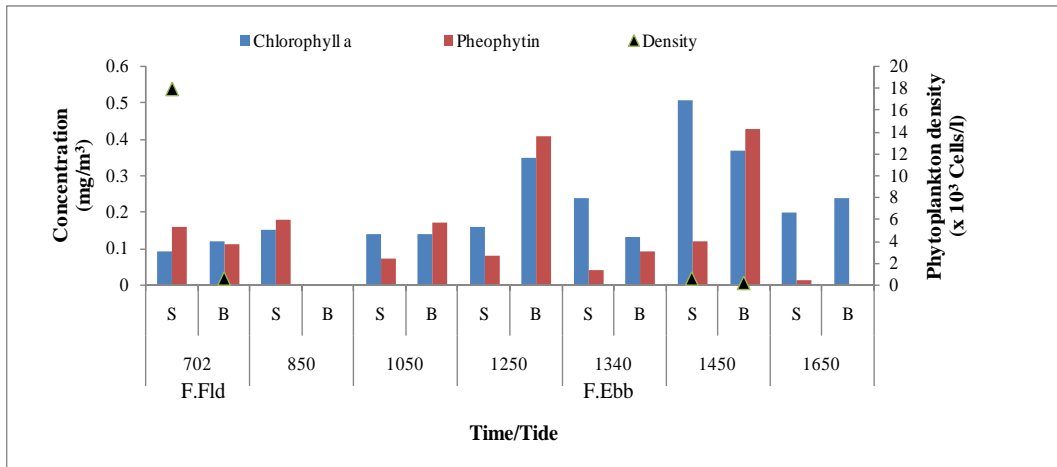

Figure 4.2.2 (b): Temporal variation of phytopigments and total phytoplankton density in the column of station L5 on 13th October 2022

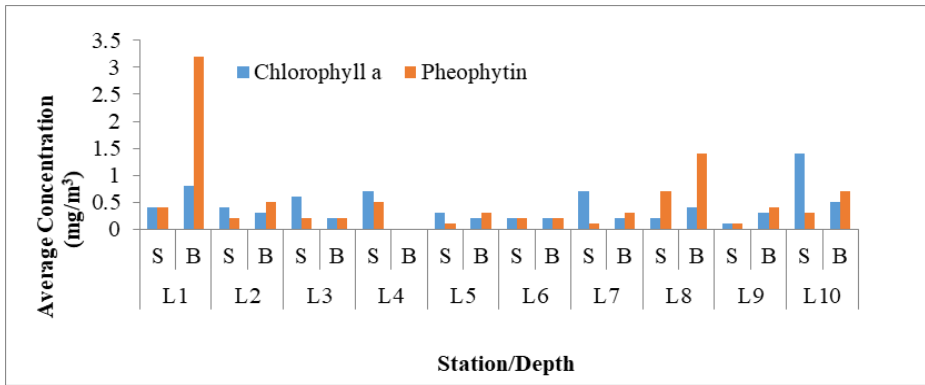

Figure 4.2.3: Distribution of phytopigments in the study region

The study exhibited very low chlorophyll a ( $>0.8 \text{ mg/m}^3$ ) in most of the stations (surface and bottom) sampled except at station L10 which exhibited  $1.4 \text{ mg/m}^3$  concentration. On an average pheophytin ranged between  $0.1 \text{ mg/m}^3$  and  $3.2 \text{ mg/m}^3$  during the study period (Figure 4.2.3). There was no observation in bottom water of station L4 as the depth was low ( $>3\text{m}$ ).

**b) Population:**

The phytoplankton population in terms of cell count ( $0.1\text{-}150 \times 10^3 \text{ Cells/l}$ ; av.  $18.6 \times 10^3 \text{ Cells/l}$ ) also revealed variability in their distribution (Table 4.2.3). Phytoplankton population was found to be more pronounced in the surface water of most the stations compared to bottom water as given in (Figure 4.2.4) below. Phytoplankton population was found to be very low at stations L1, L8 and L9 in the entire water column. The probable reason is high amount of suspended sediment which is difficult to segregate from phytoplankton sample.

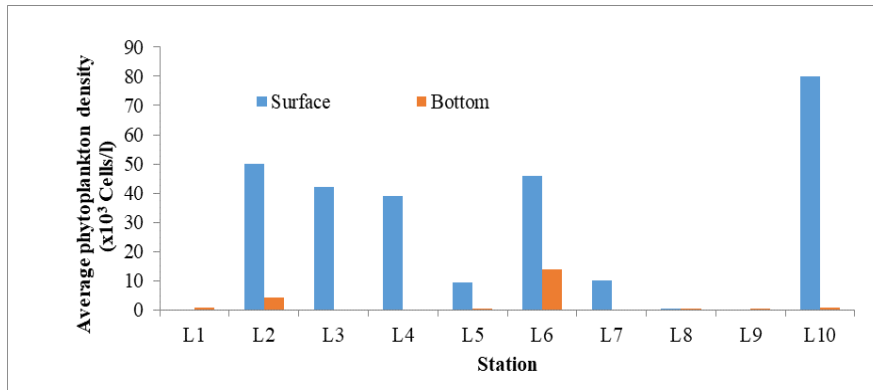

Figure 4.2.4: Spatial variation of phytoplankton density (average) in the study region

Overall, 39 genera was encountered and varied between 2 and 10 (av. 5) though all of them were not encountered at any single location, among them, 13 species were identified to species level and quantified (Table 4.2.3 and Plate 6).

The highest overall average percentages of phytoplankton composition in the study region were *Merismopedia* sp., *Navicula transitans*, *Gymnodinium* sp., *Nitzschia* sp., *Synedra* sp., *Navicula* sp. *Cyclotella* sp., *Pseudo-nitzschia* sp., *Coscinodiscus* sp., *Amphora* sp. *Nitzschia acicularis* (Table 4.2.4).

Overall the results of phytoplankton study revealed a good productivity both in terms of phytoplankton biomass and population with fairly good generic diversity. Although phytoplankton biomass and population varied widely in each zone it is a common fact in coastal areas which is influenced by tide. The chlorophyll *a* : pheophytin ratio which is considered as the stress factor for phytoplankton growth was found always >1, which indicates that phytoplankton was not under any kind of stress related to anthropogenic activities.

### c. Zooplankton

The zooplankton community is an important element of the aquatic food chain. These organisms serve as an intermediary species in the food chain, transferring energy from

planktonic algae (primary producers) to the larger invertebrate predators and fish who in turn feed on them. Because zooplanktons are not normally harvested by people, have limited control over their movement and have short generation times, they respond to changes in their environment in rapid and unambiguous ways. This makes zooplankton useful indicators of ecosystem change.

Temporal variation of zooplankton biomass, population density and total group at station L5 is given in Figure 4.2.5 below. It was observed that zooplankton biomass and total groups did not show temporal variation according the rise and fall of the tide, while total population showed significant temporal variation with increasing population from flood to ebb period. Plate 7 shows the different zooplanktons observed in the study area.

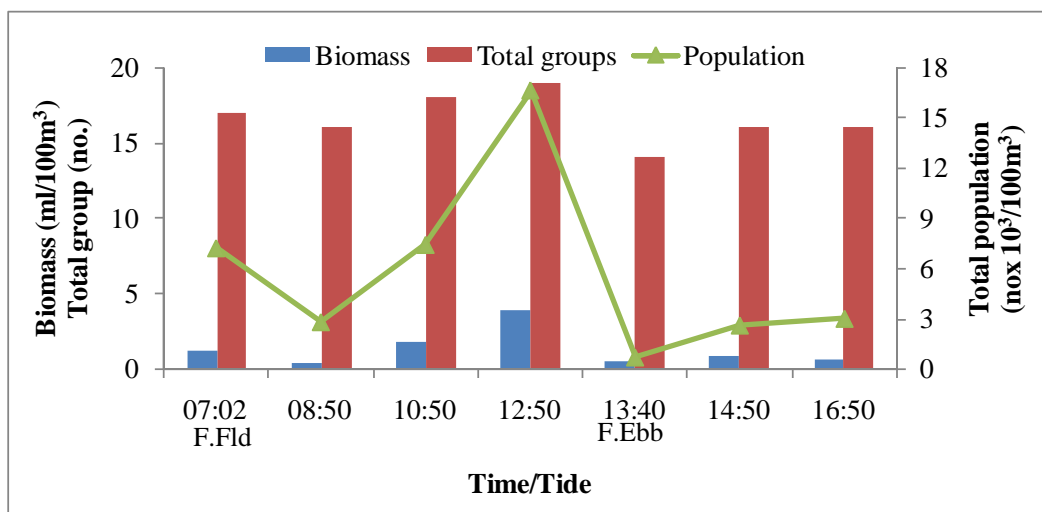

Figure 4.2.5: Temporal variation of zooplankton biomass, population density and total group at station L5 during on 13th October 2022 in the study region

Spatial variation of zooplankton biomass and population density is given in Figure 4.2.6 below. Zooplankton biomass in the study region varied from 0.1 to 8.0 ml/100m<sup>3</sup> and total population density ranged between 0.1 and 53.8 x10<sup>3</sup>/100m<sup>3</sup> (Table 4.2.5). Maximum biomass and density was observed at station L8, while stations L2, L3, L6 recorded the minimum biomass and density. Total zooplankton group in the study region

ranged from 6 to 23 nos. with maximum number of group at station L1 followed by L9 and L10 (Table 4.2.5). No observation was made at stations L4 and L7 due to high load of suspended sediments which possibly will clog the mesh of the zooplankton net.

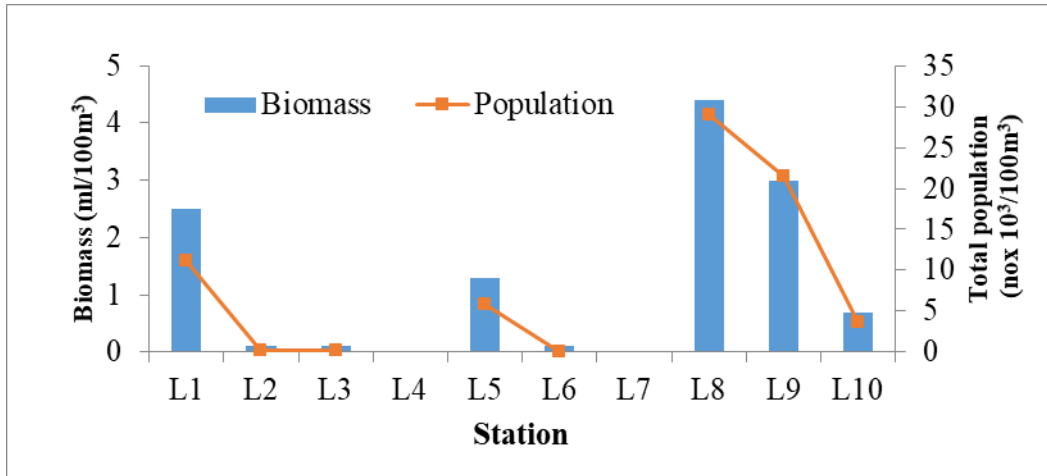

Figure 4.2.6: Spatial variation of zooplankton biomass and total population in the study region

Percentage composition of zooplankton community is given in the Figure 4.2.7 below. The study revealed that copepod was the dominant group contributing >80% to the total community. The second dominant group was chaetognatha followed by zoea (decapods larvae). Since copepod group were the major contributor to the total zooplankton community, their family level study was carried out. It was observed that family calanoida (pelagic form) was the major family contributing 12 families while family harpacticoida (benthic form) only 3 families was encountered (Table 4.2.6). Calanoid copepods are very good feed for pelagic fishes.



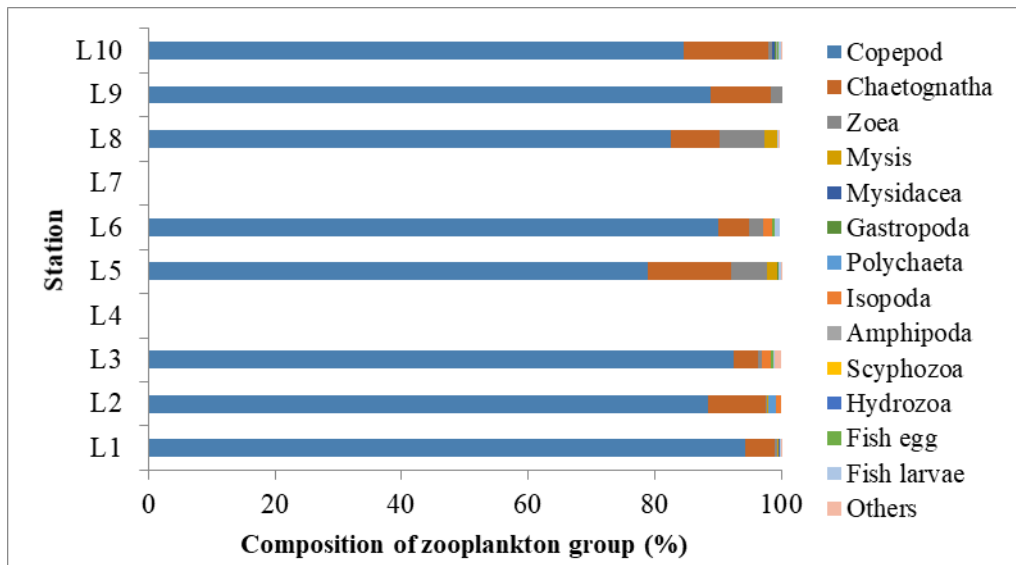

Figure 4.2.7: Percentage composition of zooplankton community in the study region

**Breeding and spawning:**

To identify breeding grounds of fishes and crustaceans extensive field observations over a long duration are required. This approach was not possible during the present short-term investigations. Hence, alternatively decapod larvae, fish eggs and fish larvae were studied from zooplankton collections and taken as indices of probable existence of spawning grounds.

**Decapods:**

This group was an important constituent of zooplankton. Decapod larvae was encountered in all the sampled stations and contributed about an av. 2.7% to the zooplankton population (Table 4.2.6).

**Fish eggs and larvae:**

Fish larvae (av. 0.3%) were low in number in the zooplankton samples. Fish eggs though at a percentage (av. 0.1%), were encountered in most zooplankton collections

(Table 4.2.6). In general, the study area sustained low numerical abundance of fish larvae probably because the study area was not the breeding grounds for fishes.

It is evident from the study that the zooplankton productivity in terms of biomass and population varied widely, as commonly observed for coastal areas which are under tidal influences. However, the study indicates that zooplankton was not under any kind of stress related to anthropogenic activities.

#### **d. Benthos**

##### **a) Intertidal macrobenthos**

During present study intertidal macrobenthos were studied from 4 transects of the Dahej coast. The intertidal macrobenthic standing stock in terms of population and biomass varied between 0.0 to 1125 no/m<sup>2</sup> (av. 360 no/m<sup>2</sup>) and 0.0 to 8.7 g/m<sup>2</sup>; (av. 1.3 g/m<sup>2</sup>; wet wt) respectively in the study area. IT-II and IT-III recorded the maximum macrobenthic biomass, population and faunal compared to transect IT-II and IT-IV (Table 4.2.7a).

The faunal composition indicates overall dominance of phylum annelida (75.5%) followed by phylum mollusca (14.5%) and phylum arthropoda (9.4%). Under phylum annelida the dominant species was *Micronereides capensis* (47.2%), *Notomastus* sp. (6.2%), *Paraprionospio patiens* (6%) *Glycera longipinnis* (3.1) Table 4.2.7b (Plate 8).

##### **b) Subtidal macrobenthos**

Samples for macrobenthos were obtained from subtidal region for the estimation of macrobenthic biomass, population and composition.

The faunal standing stock of benthic macrofauna in terms of biomass 0.0 to 1.3 g/m<sup>2</sup> (av. 0.1 g/m<sup>2</sup>) and population 0.0 to 75 no/m<sup>2</sup> (av.10.1 no/m<sup>2</sup>) varied widely in study area (Table. 4.2.8a).

Only phylum annelid was encountered during the study period and the dominant species observed under this phylum was *Nephtys paradoxa* found in 100% at stations L3, L6 and L9 (Table. 4.2.8b). No macrobenthic fauna was recorded from stations L2, L4, L7 and L10.

## **e. Meiofauna**

### **a) Intertidal meiobenthos**

The meiobenthos biomass during the study period ranged from 0.3 to 340 $\mu\text{g}/10\text{cm}^2$  (av. 63.0 $\mu\text{g}/10\text{cm}^2$ ) with the highest biomass recorded from Transect IT-III compared to other transects. The meiobenthos population ranged between 7 and 499 no./10 $\text{cm}^2$  (av. 270.25 no./10 $\text{cm}^2$ ) with highest population displayed from Transect IT-III compared to other transects. The meiobenthos group ranged from 1 to 5 nos. (av. 2 nos), IT-III recorded the highest number (5 nos.) (Table 4.2.9a).

The meiobenthos faunal groups contributing highest to the total percentage composition were comprised of Nematoda (80%) followed by Copepoda (10 %) and Nauplius (5%) and Polychaeta (4%) (Table 4.2.9b).

From the above table it is evident transect IT-III sustains high biomass and population of meiobenthic organisms in comparison with other intertidal areas during all the sampling years. The high biomass and population of meiobenthic organisms at transect IT-III indicates that the area is not affected by any anthropogenic activity as transect IT-III is in the vicinity of the project site.

### **b) Subtidal meiobenthos**

Samples for meiobenthos were obtained from subtidal region for the estimation of meiobenthic biomass, population and composition. The faunal standing stock of benthic meiofauna in terms of biomass (0 to 108.4  $\mu\text{g}/10\text{ cm}^2$ ; av.7.3  $\mu\text{g}/10\text{ cm}^2$ ) and population

(0 to 25.01 no./10 cm<sup>2</sup>; av.5.18 no./10 cm<sup>2</sup>) varied widely. Maximum biomass was observed at station L3 whereas, maximum population was at station L5 (Table. 4.2.10a).

The faunal composition indicates overall dominance of Nematoda (83%) followed by Copepoda (7%), Halacaroida (5%) (Table. 4.2.10b).

Some (Plate 12) which were observed during intertidal benthic macro and meiofaunal sample collection.

### **4.3. Mangroves**

Mangrove ecosystems are an integral and important part of tropical marine environments and a crucial breeding ground for fish, crabs, and shellfish. Mangroves also serve as a filtration facility and silt trap for overland runoff, reducing shoreline erosion and boosting the productivity of the ecosystem. Mangroves shield nearby populations from storm surges, flooding, and coastal erosion. Erosion control can lead to shoreline accretion, which is another function attributable to mangroves. Mangroves serve as silt traps that control the quality of the nearby coastal waterways by filtering out debris through their enormous root systems, which also slows the flow of muddy rivers and streams. Additionally, mangroves serve as pollution "sinks" for urban pollutants such chemicals, herbicides, and fertilizer residues as well as runoff from agriculture. Mangroves serve as the foundation of a complex food web that supports coastal, estuarine, and pelagic fisheries as well as a "clearing house" for the export of nutrients and other organic waste.

Gujarat hosts the second largest mangrove cover (1103 sq.km) of the country (4628 sq.km). The mangrove cover of the state is distributed over four regions, Kachchh, Gulf of Kachchh & Saurashtra and South Gujarat (including Gulf of Khambhat- Dumas Ubharat areas). However, the mangrove cover is distributed unevenly over these four regions and Kachchh has the highest mangrove cover (71.5%) of the state. Further, Gulf of Kachchh,

Saurashtra and South Gujarat (including areas of Gulf of Khambhat and Dumas-Ubharat) have 15.6%, 0.3% and 12.6% of the total mangrove cover of the state respectively. Fifteen species of mangroves are found in Gujarat, of which *Avicennia marina* is the most dominant species. In fact, it represents about 97% of the total mangrove cover of the state.

Bharuch takes up the third position in the highest mangrove cover of the Gujarat state. For the mangrove survey, two locations were selected for survey (IT-II and IT-IV) to study the plant density and diversity by selecting 3 quadrats in each location (Plate 4 and Plate 5). In IT-II, the first location, from each quadrat *Avicennia marina* was recorded. Big and intermediate plants were recorded more in the first quadrat, while seedlings were recorded more from the third quadrat. From the 3 quadrats, the tallest plant was recorded from the second quadrat, while the shortest plant was recorded from the third quadrat.

In the case of IT-IV, the second location, even from this location from each quadrat *Avicennia marina* was recorded. Big plants were recorded all the same in each of the quadrats. While intermediate plants were recorded more from the third quadrat, the seedlings were recorded more from the first quadrat. From the 3 quadrats the tallest plant was recorded from the third quadrat, and the shortest plant was also recorded from the third quadrat.

In both the locations, during the survey many small crabs, mud skippers, crabs and gastropods were also observed (Plate 11). From the study it can be concluded that *Avicennia marina* is the dominant species recorded from these regions.

#### **4.4. Fisheries**

Fisheries play a major part in the Indian economy and in the country's socioeconomic growth. It contributes to national income, exports, food and nutritional security, and job

creation. More than 2.8 crore fishermen and fish farmers are employed in the fisheries sector at the primary level, with many more employed further up the value chain. This industry is also a major source of income for a substantial portion of the country's economically disadvantaged people, particularly in coastal districts.

Gujarat is primarily a marine fish producing state, as indicated by 1600 kilometres of coastline, which accounts for 19.71% of the country's entire coastal base. The state also has 2.14 lakh square kilometres of Exclusive Economic Zone.

Fishing in the Narmada Estuary is the backbone of coastal Bharuch district. The existing fishery status of the region was assessed on the basis of data collected from the Department of Fisheries, Government of Gujarat and fishes obtained from the local fishermen who were identified.

The present oceanographic survey was in Bharuch district, therefore the information regarding the fishery status will be more related to this district. A market survey was carried out to observe the present fish population (Plate 9 and Plate 10). As per the data collected the highest fisher man population is in Bharuch (Table 4.4.1), different fishing villages under this district which showed more than two hundred active fishermen population in Malpur, Kantiyajal, Kavi and Dahej (Table 4.4.2). Information on fishermen vehicle and fish production from 2009-2021 indicated that number of mechanized and non-mechanized boats remained almost the same, however, the fish production (metric ton) increased from 2018 to 2021 (Table 4.4.3). According to the survey made by fisheries department during 2020-2021, the type of mechanized boats used in Bharuch is gillnetter (232 nos.) and FRP IBM (489 nos.). However, non-mechanized boats were also used in Bharuch which is 940 nos. The major landing center include Kavi, Kamboi, Malpur, Zamdi, Bhadbhut, Megham, Lakhigam, Luvara, and Hansot and the major fish

species from these landing centre includes catla, rohu, mrigal etc. as described in Table 4.4.4.

The year wise inland fish production in Bharuch, district from 2005-2020 is given in Table 4.4.5. It was observed that Bharuch district contributed 13.72% to the total production.

Centre wise and species wise marine fish production (production in kilogram) from 2010 to 2020 in Bharuch district are given in Table 4.4.6-4.4.16. The marine fishes mainly available in this region are Bombay duck, mullet, catfish, other clupeids, levta, shrimp, and crab, which were found throughout. From 2010-2020 the highest production occurred in the centre Kavi and lowest in the centre Luvara (Table 4.4.6-4.4.16).

The centre wise distribution (2010-2020) of fish production shows that Bombay duck is mainly captured from Malpur (Table 4.4.7-4.4.16). However, the highest year wise and centre wise catch of Bombay duck was recorded in 2011-12 from Kantiyajal (Table 4.4.7). Similarly the centre wise production from 2010-2020 of mullets, catfish and other clupeids were observed highest from Kavi (Table 4.4.7-4.4.16). The highest production of mullets and catfishes both centre wise and year wise occurred in the year 2012-13, from Kantiyajal (Table 4.4.8), whereas in the case of clupeids the highest year wise production was recorded in the year 2011-12, (Table 4.4.7) and the highest centre wise production was recorded in Kavi in 2019-20 (Table 4.4.15). In the case of Levta both year wise and centre wise production was found to be highest in the year 2012-13 from Kantiyajal (Table 4.4.8).

Shrimp is the highest contributor to the shell fish production in Bharuch district; it is mainly contributed by Kavi and the least by Kantiyajal. The highest year wise production of shrimp occurred in the year 2012-13 (Table 4.4.8), whereas the highest centre wise

production was recorded from Zamdi in 2013-14 (Table 4.4.9). Crab production is significantly low from this region. When we combine the production from 2010-2020 the highest production occurs in the center Lakhigam. Also the highest ever crab production both year wise and centre wise occurred in 2019-20 from Kantiyajal (Table 4.4.15). One interesting fact about crab production is that; when all the other fish production was decreasing over the years the crab production was increasing with the exception of its decrease in the year 2020-21.

In the case of Hilsa production, it can be noted that its production is significantly low in this region. The production is recorded highest from Lakhigam from 2010-2020 (Table 4.4.6-4.4.16). The year wise highest production was noted in the year 2020-21 (Table 4.4.16). The year wise total production of Hilsa from different centres (Malpur, Kavi, Kantiyajal, Luvara, Lakhigam, Zambdi) of Bharuch district is given in Figure 4.4.1. The probable reason for the low production in Hilsa fishery is due to lack of fresh water inflow.

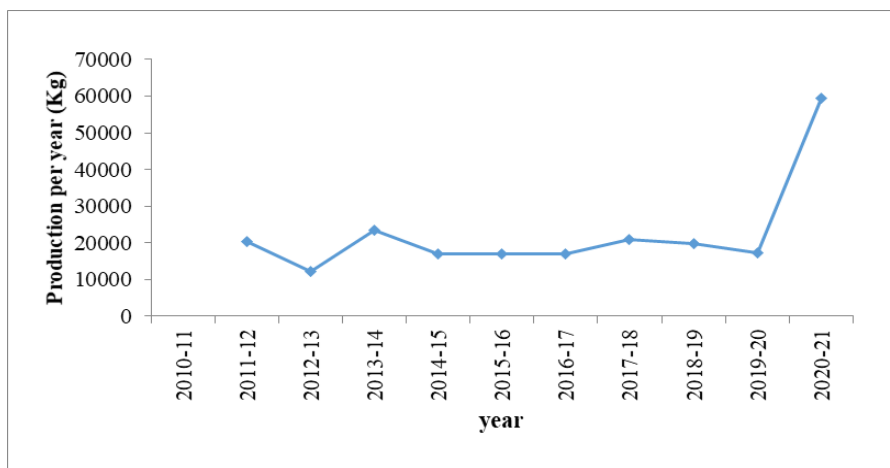

Figure 4.4.1: Total production of Hilsa from different centres (average) of Bharuch district

From the above discussion it is understand that the overall marine fish production in Bharuch district was highest in the year 2011-12 (Table 4.4.7). In this year the highest



production was from Kantiyajal. The lowest production as expected occurred in the year 2020-21 (Table 4.4.16) as it was a tough time for all the sectors due to the condition the world was going through (COVID-19).

#### **4.5. Corals and associated flora and fauna**

The coastal water of Dahej does not support corals as the intertidal area is largely sandy or muddy. Coral growth in the subtidal region is unlikely in view of the high suspended load in the water column, the conditions under which corals do not thrive.

#### **4.6. Avifauna**

Avifauna birds find near perfect environment in the mangrove forests lining the islands and along the coasts, coral reefs, reef vegetation, mudflats, sandy beaches, rocky shores, tidal creeks, marsh vegetation and salt pans that provide an assemblage of micro-habitats which facilitates suitable conditions for feeding, breeding and sheltering areas of a variety of waterfowls and other birds in Gulf of Khambat included Dahej region. A large number of migratory birds from Arctic and sub-Arctic regions pass through the Gulf and a small population of most species consisting mainly of juveniles and non-breeding adults takes shelter in this region, during summer.

In the study area, 20 varieties of birds were observed in the intertidal region, some of the birds are illustrated in Table no 4.5.1. The diversity of birds varied between transects due to differences in microhabitats. The bird curlew sand piper (*Numenius arquata*) was the most common and dominated the intertidal region. Further, most of the birds found in the present study have a preferred diet of annelid worms, crustaceans, mollusks etc.

#### **4.7. Reptiles and mammals**

Marine turtles are commonly represented by Loggerhead (*Caretta caretta*) and Olive Ridley (*Lepidochelys olivacea*) along west coast. Other turtles like Hawksbill

(*Eretmochelys imbricata*), Leather back (*Dermochelys coriacea*) and green sea turtle (*Chelonia mydas*) are occasionally sighted at the sea coast. The marine mammals are chiefly represented by Dolphin and Porpoise in the coastal waters of Dahej. However, these marine habitats were not sighted at Dahej coast during the field study.

## **5. ANTICIPATED MARINE ENVIRONMENTAL IMPACTS AND MITIGATION MEASURES**

### **5.1. Environmental impacts of construction of berth (jetty)**

Article 1(4) of the 1982 United Nations Convention on the Law of the Seas (UNCLOS) defines pollution of the marine environment to mean the introduction by man, directly or indirectly, of substances or energy into the marine environment which is likely to result in negative effects on living resources, are hazardous to human health, a hindrance to marine activities including fishing and other legitimate uses of the sea, cause an impairment in quality for seawater uses and the reduction of amenities. As a part of the present study, anticipated environmental impacts associated with the proposed project have been identified and listed below:

- Berth (jetty) construction and intertidal area reclamation
- Impact of dredging and disposal
- Air pollution from berth (jetty) operations
- Noise and light pollution
- Impact of cargo handling
- Hazardous materials and oil
- Ship and cargo vessel generated wastes
- Introduction of non-native species into the marine environment
- LNG spill

#### **a. Berth (jetty) construction and Intertidal area reclamation**

Construction of berth (jetty) contributes significantly to the economy of any nation; they also pose many adverse effects on the environment. The major environmental effects caused by port activities, berthing ships, and emissions from intermodal transport

serving the port hinterland includes localized ambient air pollution, water pollution, noise and light pollution, traffic congestion, the introduction of invasive species, effects on marine ecosystems and impacts of marine accidents and spills. Reclamation of coastal intertidal land often results in many environmental problems: immediate impact on coastal ecosystems, geological disasters, and the deterioration of marine environmental quality. Reclamation leads to loss of biodiversity, loss of ecosystem-service values, landscape fragmentation and loss of water bird habitats.

#### **b. Impact of piling and disposal**

The potential effects of piling can be divided into two. One is the impact of piling on the piling site and the second impact of the piling disposal. Piled material may come into suspension in the water column because of many activities like disturbance of the substratum, during transport to the surface, overflow from barges or leakage of pipelines, during transport between piling and disposal sites, and during disposal of piled material.

Turbidity changes induced by piled will result in adverse environmental effects when the turbidity generated is significantly larger than the natural variation of turbidity and sedimentation rates in the area. Turbidity created by piling will cause clogging and smothering effects on filter-feeding organisms such as mussels, oysters, bivalves etc. Piling may affect the physical environment by altering current velocities and wave conditions which affect the sedimentary regime in the region. Piling and disposal of piled material can lead to a temporary decrease in water transparency, increased concentrations of suspended matter, and increased rates of sedimentation. In the case of contaminated sediment or sediments with high contents of organic matter, piling and re-suspension may also lead to effects on water quality by the release of contaminants leading to an increase in nutrients concentration and reduced dissolved oxygen in the water column.

Physical removal of substratum and associated plants and animals from the seabed and intertidal regions and burial due to subsequent deposition of material is the most likely direct effects of piling and reclamation projects. New habitats may also be created as a result of the operation, either directly in the piled area or by the introduction of new habitats on the slopes of a reclaimed area (like hard substratum in the form of breakwaters).

The degree of adverse environmental impacts caused by piling and disposal depends on the quantity, frequency and duration of piling, methodology of piling and disposal, physical dimensions and water depth of the piling location, grain-size composition, density and degree of contamination of the piled material, background water quality, seasonal variations in weather conditions (wind and waves), and proximity/distance of ecologically sensitive or economically important areas or species relative to the location of the dredging or disposal site. Depending on these factors, there can be considerable spatial and temporal variation in effects.

### **c. Air pollution from berth (jetty) operations**

The major air pollutants related to berth (jetty) activities that can affect human health include diesel exhaust, particulate matter (PM), volatile organic compounds (VOCs), nitrogen oxides (NO<sub>x</sub>), ozone, and sulfur oxides (SO<sub>x</sub>). Particles directly emitted in the exhaust typically contain mineral ash, metals, black carbon (soot), condensable organics and sulphate. These particles, when leaving the ship stack, are very small (< 0.1 µm). During the ageing of these emissions in the atmosphere, secondary particulate matter is formed when the ship exhaust gases are oxidized and react with other pollutants like ammonia and volatile organics. Shipping also contributes to air pollution with emissions of carbon monoxide and polyaromatic hydrocarbons (PAH). Besides influencing particle formation, nitrogen oxides and VOC emitted by shipping affect tropospheric ozone formation.

#### **d. Noise and light pollution**

Noise associated with shipping and berth (jetty) operations is another major factor that has the potential to cause disturbance to marine animals, including marine mammals, fish and birds. Marine mammals are known to continue to use areas with very high levels of boat traffic and noise. However, there is concern over noise pollution in general which tends to center on the possible behavioral effects and that in the worse cases marine mammals, fish or birds may be driven away from their home territories. Studies reported that noise and erratic boat movements can distract the feeding behaviour of dolphins and drive them away. Artificial night lighting affects the natural behaviour of many animal and bird species. It can disturb activity patterns and internal clock mechanism in birds.

#### **e. Impact of cargo handling**

Handling of liquid bulks may require discharge through pipelines, which provides the potential for leaks, emissions and spillages. Sources of atmospheric pollution can stem from cargo vapour emissions. Release of cargoes into the marine environment may have direct environmental effects, as in the case of the loss of toxic substances, or indirect effects, such as the loss of non-toxic organic rich substances which may result in oxygen depletion on their breakdown. Some dry bulk cargoes have high concentrations of organic material and/or nutrients, such as fertilizers and animal feed, with high biological oxygen demands, large spillages of these may cause localized nutrient enrichment and oxygen depletion. This may result in the suffocation of marine life in the vicinity.

#### **f. Hazardous materials and oil**

Hazardous materials at ports include large volumes of hazardous cargo, as well as oil and fuels and hazardous substances used in berth (jetty) activities including vessel, vehicle, and grounds maintenance. Spills may occur due to accidents (e.g. collisions, groundings, fires), equipment failure (e.g. pipelines, hoses, flanges), or improper

operating procedures during cargo transfer or fuelling, and involve crude oils, refined products or residual fuels, liquid substances, and substances in packaged form.

#### **g. Ship and cargo vessel generated wastes**

Ship-source marine pollutants emanate from cargo carried or waste generated onboard, which usually contains oil or oily mixtures and noxious substances. They accumulate from machinery operation or from the domestic activities of the crew living onboard. Mineral oil in the stern tube lubricating bearings supporting the propeller shaft, contained by shaft seals with certain operational leakage and solid wastes.

#### **h. Introduction of non-native species into the marine environment**

Rapid globalization and increasing trends of trade, travel and transport in recent decades have accelerated marine biological invasions by increasing rates of new introductions of non-native organisms through various pathways, such as shipping, navigational canals, aquaculture, and the aquarium trade. Shipping plays a major role in the introduction of non-indigenous organisms through ships ballast water and associated sediments and fouling on ships hulls. Biological invasions severely challenge the conservation of biodiversity and natural resources. They are considered to be one of the most important direct drivers of biodiversity loss and major pressure on several types of ecosystems, with both ecological and economic impacts. In marine ecosystems introduction of alien marine species may become invasive and displace native species, cause the loss of native genotypes, modify habitats, change community structure, affect food web properties and ecosystem processes, impede the provision of ecosystem services, impact human health, and cause substantial economic losses.

#### **i. LNG spill**

LNG is a colorless, practically odorless petroleum hydrocarbon, comprised of low molecular weight hydrocarbons, mostly methane (approximately 85% to 99%). It also has

small amounts of ethane, propane and butane. The properties of LNG and its exact composition are important since this affects the LNG's behavior, as under spill conditions. The potential hazard of LNG spill over water includes asphyxiation, cryogenic burns, and cryogenic damage to the ship from the very cold LNG, dispersion, fires, and explosions. LNG vapors can displace oxygen and act as an asphyxiant in a vapor cloud until the vapors rise and disperse. LNG also presents a cryogenic hazard for people and other living organisms (plants and animals). Since the temperature of LNG is -160 degrees C, it will freeze any tissues that it contacts. LNG spilled into water can lower the water temperature in the immediate vicinity and, depending upon how much is spilled and how quickly it vaporizes, it will probably freeze some water which will float as ice on the surface. The extent of damage caused by LNG spill depends upon the quantity of LNG spill and oceanographic and meteorological conditions prevailing in the location where the spill has occurred.

For the construction of proposed third berth (jetty) no land reclamation will be done and no dredging is envisaged. All safety guidelines, standard operating procedures and emergency response plan are in place and the terminal is safely carrying out the ship operations in its existing two jetties for past almost 25 years following Standard Society of International Gas Tanker and Terminal Operators (SIGTTO) guidelines. As LNG ships run on Boil Off Gas (BOG) generated in cargo tanks and LNG being a clean fuel, there are no major gas emissions. For handling ship and cargo vessel generated waste, Oil spill etc. MARPOL guidelines are followed.

## **5.2. Construction phase impacts on the marine environment**

Various activities during the construction and operation phase of the project, which are likely to cause an impact on various environmental components. Impacts of the proposed third jetty project on the intertidal and near-coastal environment during the



construction phase can be generally classified into impacts on water quality, sediment quality and impacts on various flora and fauna present around the Dahej coastal region.

#### **a. Water Quality**

Dredging and reclamation in the intertidal area for constructing port, seawall, jetty head, approach trestle, berth (jetty) pocket and turning circle has high potential to disperse the bed sediment into the water column thereby increasing the suspended sediments in water and degrading the water quality locally. Due to the permanent damage caused to bottom biota, there is a potential risk to fishery resources and may lead to an increase in some undesirable species of biota. This can lead to water quality deterioration and affect adversely on the marine and coastal ecology locally.

When the bed is disturbed due to the construction activities the fine particles may remain in suspension, though locally, for some period. The SS generated due to dredging and piling activities could render the water muddy and turbid with an increase in SS, though locally. The changes in salinity due to bed disturbance are not expected.

Several types of floating platforms such as barges, cranes, ships etc. will be deployed in the area during construction. An accident involving such platforms may lead to the loss of onboard construction material and fuel. In the absence of mitigation and containment measures, the materials may sink to the bed and the fuel spill would deteriorate the water quality of the region. Thus, apart from local transient pulses of SS and deterioration due to accidental spillages, the water quality of the region will not be influenced adversely during the construction phase.

#### **b. Noise**

The impact of anthropogenic underwater sound on marine biota is an important environmental aspect. Sound speed in water is about 4.5 times more than that in air and absorption is less compared to air. Consequently, many marine organisms are very well

adapted to emit and receive sound and they use it for a variety of functions such as communication, mating, searching prey, predator, hazard avoidance, and for short- and long-range navigation. In the marine environment, pile driving can produce some of the most intense anthropogenic noises.

There are several factors which affect the type and intensity of sound pressure waves during piling such as the size and material of the pile, the firmness of the substrate, and the type of pile-driving hammer that is used. Piling activity may contribute to the behavioural changes in marine organisms. Studies have shown clear behavioural reactions in fish due to a variety of sounds, sometimes at relatively low received sound pressure levels. Behavioural responses due to piling noise might happen anywhere within the zone of audibility and that the responses could potentially prevent fish from reaching breeding or spawning sites. This could result in long term effects on reproduction and population parameters.

The anthropogenic noise propagation, which is dependent on its frequency, characteristics and duration, may have some impact on certain fishes unless noise control measures are undertaken during construction activities. Fish may leave an area for more suitable spawning grounds or may avoid a natural migration path because of noise disturbances.

### **c. Impact on Flora and Fauna**

#### **a) Phytoplankton**

In general, an increase in turbidity due to dispersion of fine-grained sediment in the water can lead to reduced light transmittance which in turn may influence photosynthesis and consequently may affect the primary productivity. The study area sustains high muddy content and thus, an enhancement of suspended sediments during the piling

activities will cause an impact on phytoplankton production resulting in a decrease in phytoplankton standing stock. The degradation of chlorophyll *a* to phaeophytin is also expected due to the enhancement of SS in the region. In general, the recovery of phytoplankton production will be fast after the completion of piling activities.

## **b) Macrobenthos**

The impact on the intertidal area and subtidal region by dredging, piling, jetty construction and berth (jetty) creation on biotic community result mortality due to mechanical damage and complete loss of intertidal habitat in some parts. Proposed constructions would have an adverse impact on the benthic habitats which would be destroyed in the areas directly disturbed. The total area under piling construction is about 2630 m<sup>2</sup>. In this 380 m<sup>2</sup> falls in offshore region for Jetty Head & unloading platform and 2250 m<sup>2</sup> falls in the intertidal region of the study area. The average values of biomass (1.3 g/m<sup>2</sup>, wet. wt.) and population (360 no/m<sup>2</sup>) present at the intertidal segment are worked out to assess the permanent loss of macrobenthic standing stock in the proposed reclamation area in the intertidal segment and approach trestle (Section 5.4.3.1). The rest of the project activities like Jetty head & unloading platform construction, berth (jetty) pocket etc. falls in the subtidal region of the study area. For benthic loss assessment of these segments, the average values of biomass (0.10 g/m<sup>2</sup>, wet.wt.) and population (10.1 no/m<sup>2</sup>) for the subtidal region were used (Section 5.4.3.1). The total benthic biomass loss estimated for the developments is about 0.786 kg (Table 5.2.1).

Table 5.2.1: Estimation of Macrobenthos loss

Segment	Affected Area (m <sup>2</sup> )	Loss of Macrobenthos	
		Biomass (kg)	Population (nox10 <sup>4</sup> )
Approach Trestle (Intertidal region)	2250	0.730	202320.0
Jetty Head & unloading platform (Intertidal region)	380	0.056	5676.2
Total	2630	0.786	207996.2

Moreover, this loss would be temporary and the benthos would re-colonise in due course of time, once the activities are terminated and contours are restored after construction activities are over.

#### d) Mangrove vegetation

The activities proposed to be carried out at the proposed third jetty site are confined and there are no mangrove in the proposed site, therefore direct impact on the mangroves is not anticipated.

#### e) Fisheries

The coastal area of Dahej is traditionally not a fishing and gill-netting zone. Major fishing activities like trawling are not noticed in the nearshore water of Dahej. The enhancement of SS due to piling and other construction activities is expected to have minor temporary impact in herbivorous fish larvae.

## **f) Avifauna**

As the proposed project area does not contain mangroves, the congenial environment for migratory and resident birds is absent. Some birds were seen along the shore in the study area and since impact due to piling will be only localized during construction phase no adverse impacts is anticipated.

## **g) Reptiles and mammals**

Marine habitats like Marine turtles, Dolphin and Porpoise are the residential reptiles and mammals observed in the study area. These were not sighted at Dahej coast during the field study. However, the noise and disturbances due to piling and other construction activities is expected to have minor temporary impact on their habitat.

### **5.3. Operational phase impacts on the marine environment**

Possible marine environmental implications during the operational phase of the port are mostly associated with various emissions to air, ship accidents and grounding due to increasing in traffic at the zone, accidental spills of products handling in the berth (jetty), discharge of wastes from jetty, ships and oil spills. Accidental spillages of these products can result in damage to the environment and assets, the severity of which would depend on the product and the quantity involved, location of spillage, environmental conditions etc.

#### **a. Emissions to atmosphere**

Berths (jetties) are major sources of air pollutants that affect the health of people living in nearby communities and contribute to regional air pollution problems. The major air pollutants related to berth (jetty) activities that can affect human health include diesel exhaust, particulate matter (PM), volatile organic compounds (VOCs), nitrogen oxides (NOx), ozone, and sulfur oxides (SOx). Particles directly emitted from the exhaust

typically contain mineral ash, metals, black carbon (soot), condensable organics and sulphate. Shipping also contributes to air pollution with emissions of carbon monoxide and polyaromatic hydrocarbons (PAH).

**b. Berth (jetty) related waste**

The wastes generated at berth (jetty) in normal operations include domestic effluent, garbage and solid wastes (debris, leftover plastic items etc.). Liquid and solid wastes if not properly collected and disposed can potentially cause degradation of the terrestrial as well as the marine environment. A site in the vicinity of the jetty will be cordoned and marked as a solid waste collection site. Solid wastes will be segregated at this site and stored separately and will be disposed as per prevailing norms.

**c. Ship related wastes**

A number of sources of waste generated from jetties can degrade water quality and reduce dissolved oxygen concentrations, including sewage discharges from ships, tugs, recreational and commercial boats etc. The four basic categories of wastes generated by ships, tugs etc. are as follows:

- Oily waste which usually consists of some oil mixed with larger quantities of seawater including fuel residues and sludges.
- Sewage generated by the crew in the ships.
- Garbage originating from the crew, the maintenance of the ship, cargo etc.

The International Convention for the Prevention of Pollution from Ships, 1973, as modified by the Protocol of 1978 (MARPOL 73/78) prohibits all ships from discharging wastes at sea which could result in pollution of the marine environment. MARPOL 73/78 applies to oil tankers, cruise ships, general cargo and container vessels, tugs, ferries, yachts and small pleasure craft. MARPOL 73/78 requires that ships retain all the wastes on board until reaching port.

#### **d. LNG spill**

LNG is a colorless, practically odorless petroleum hydrocarbon, comprised of low molecular weight hydrocarbons, mostly methane (approximately 85% to 99%). It also has small amounts of ethane, propane and butane. The properties of LNG and its exact composition are important since this affects the LNG's behavior, as under spill conditions. The potential hazard of LNG spill over water includes asphyxiation, cryogenic burns, and cryogenic damage to the ship from the very cold LNG, dispersion, fires, and explosions. LNG vapors can displace oxygen and act as an asphyxiant in a vapor cloud until the vapors rise and disperse. LNG also presents a cryogenic hazard for people and other living organisms (plants and animals). Since the temperature of LNG is -160 degrees C, it will freeze any tissues that it contacts. LNG spilled into water can lower the water temperature in the immediate vicinity and, depending upon how much is spilled and how quickly it vaporizes, it will probably freeze some water which will float as ice on the surface. The extent of damage caused by LNG spill depends upon the quantity of LNG spill and oceanographic and meteorological conditions prevailing in the location where the spill has occurred.

### **5.4. Mitigation Measures**

It is important that certain environment protection measures are conceptualized and strictly implemented at the setting up of the proposed third jetty project so that the negative impacts during construction and operational phases are reduced to a minimum in order to protect the biodiversity of the project area and avoid anthropogenic shocks.

#### **a. Mitigation measures for reducing the impact of piling activities**

A number of management techniques and mitigation measures have been developed to reduce the impact of piling activities on the marine environment. Methods like tidal piling, physical barriers, environmental dredging techniques and so forth, which may be

used to mitigate the effects of piling on sensitive organisms and on ecosystems. In hydraulic piling techniques, the piling rate can be adapted by increasing the amount of water pumped up relative to the amount of sediment that is piled, which can help to reduce the extent of turbidity plumes. Adoption of sub-suction piling, which allows for lowering of the seafloor by extracting sediment from deeper layers without disturbing the top layer is also a good option for piling in the berth (jetty) pocket and turning circle.

## **b. General practices followed during the construction phase**

### **i) Intertidal environment**

The intertidal and nearshore subtidal areas should be restored to their original contours once the construction activities are completed. General clean-up along the corridor areas should be undertaken and discarded materials including excavated soil should be removed from the site and the aesthetic quality of surroundings restored on completion of the construction phase.

### **ii) Flora and fauna**

The permanent destruction of macrobenthos along the intertidal area selected for construction of berths (jetties), the impact on the marine ecology during the construction phase is inevitable in the proposed project. The key factor in minimising the other adverse impacts mentioned earlier due to construction would be a reduction in the construction period at the site and avoidance of spillage of activities beyond the specified geographical area, which should be kept to a minimum. The piled spoil generated after trench filling in the intertidal region should be removed and properly disposed of. Workforces employed during construction often misuse the intertidal and supratidal areas. This should be avoided by establishing the temporary colonies of workers sufficiently away from the constructing sites and proper sanitation should be provided to



them to prevent abuse of the intertidal region. The noise level during the transport and construction of marine facilities should be kept to a minimum.

**c. General practices followed during the operational phase**

Possible discharges from ships that could be a source of water pollution are bilge water, oily wastes, sewage, garbage and other residues in a ship. Spills of oils, lubricants, fuels and other oily liquids may be the other sources of water pollution. Discharges and spills of these wastes can cause problems of oil pollution, floating garbage, unsanitary conditions, odour and degradation of water quality. Biodegradation of oil generates polymerized oil particles and toxic aromatic fractions using dissolved oxygen in the water and it indirectly causes damage to the bottom biota and habitat. Some oils contain carcinogenic contaminants and these are reported. Harbour authorities make an important contribution to reducing the risk of such events by undertaking their responsibilities as conservancy authorities. Furthermore, here response plans have been drawn up, an appropriate, coordinated approach to any incident will ensure that any potential damage to the environment is limited, particularly where hull ruptures and loss of cargo or fuel spillage occur.

- The proper measure should take to preserve the flora and fauna in the buffer area and surrounding area, that it would not be impacted or deteriorated by the port activities.
- Proper traffic management should be in place to reduce noise and air pollution.
- Comprehensive and easy to implement Standard Operating Procedure (SOP) will be made for each category of cargo in order to avoid spillages.
- SOPs will address safe conditions of wind, tide, visibility etc. under which operations would be permissible.
- The operating staff at the berth (jetty) will be trained in such operations and also to handle emergencies.

➤ For improved environmental safety and leak prevention, loading arms will be equipped with the following accessories:

- Hydraulic Coupler which allows rapid connection and disconnection of the arm to the tanker/pipeline flange.
- PERC installed between two disco valves to allow quick disconnection from the tanker/pipeline without draining of the arm.
- Limit switches that define 3D working envelope giving alarm at two stages.
- Emergency Shut Down (ESD).

➤ SOPs will be developed for every facet of operational OSCP that will include notification; strategy for combating depending on oil/chemical type, quantity involved and area of spill impact; deployment of booms to contain and to protect sensitive habitats, mainly mangroves; deployment of skimmers; on board and shore storage of recovered oil; strategy for shoreline cleaning and storage of oil contaminated sediment; use of dispersants; final disposal of recovered oil and contaminated sediment; closure of operation; dissemination of information to public and media etc.

➤ The oil spill combating equipment will be stored in the vicinity of the oil berth (jetty) and a suitable vessel will be always kept stand by for quick response during loading/unloading operations of petroleum and while providing bunker.

➤ Mock drills involving the deployment of critical oil spill containment and recovery equipment will be held at least once in 3 months.

➤ The oil spill combating equipment will be inspected regularly as recommended by the manufacturers and records of inspection will be maintained.

➤ Water drawl sources shall be identified and its impact shall be predicted. Similarly, wash water discharge into sea and impact prediction can be carried out.

➤ Adequacy of outfall in mitigating the adverse impacts shall be ensured by suitable study. Appropriate regulations on ship discharges and effluent from ships and provision of reception facilities are indispensable for proper control of emissions; detection of spills will be done for regulating ship discharges.

- To handle the spills recovery vessels, oil fences and treatment chemicals with a view to minimizing dispersal can be considered.
- Periodical clean-up of floating wastes is also necessary for the preservation of berth (jetty) water quality.
- The port will be fully prepared and geared up to meet emergencies such as fire due to leakages of these highly inflammable chemicals.
- Emergency responders will be properly trained and equipped in accordance with OSHA's standards on emergency response and emergency fire protection.
- OSHA's standard for the chemicals handling in the berth requires engineering controls and work practices that comply with the OSHA PELs (Personal Exposure Levels).
- Respiratory protection and Chemical Protective Clothing (CPC) to prevent contact with chemicals will be available at the berth (jetty).
- Gas monitors with provisions for alarms set at specific concentrations will be installed at strategic locations on the berth (jetty).
- The transportation of LNG, ethane and propane will meet the requirements of the International Maritime Organization (IMO) as specified in the International Maritime Dangerous Good Code and MARPOL 73/78.
- Reception facilities to be provided to receive residues and oily mixtures generated from ship operations according to the International Convention for the Prevention of Pollution from Ships, 1973 (MARPOL) as per 1978 Protocol (MARPOL, 1973/78).
  - The oily and hazardous waste generated at the port will be adequately stored and given to GPCB approved recyclers.

## **6. MARINE BIODIVERSITY MANAGEMENT PLAN (MBMP)**

### **6.1. Introduction**

Marine habitats support a wide spectrum of biota whose abundance and distribution varies both spatially and temporally. These habitats have been exploited for food and aesthetic purposes with no apparent ill effects till large scale mechanization began to be introduced. Increasing human population coupled with the greater need for development has led to intensive exploitation of coastal areas and various fishery resources and has caused considerable impacts to many habitats.

Coastal waters are the beds or nursery grounds of many marine flora and fauna, including finfishes and shellfishes, the most influencing commodity for human population growth. Various kinds of anthropogenic pollution are the principal cause of biodiversity degradation and ecosystem deterioration in coastal waters. Due to the over-exploitation and mismanagement of coastal ecosystems, these marine resources have been considerably declined. Managing a complex ecosystem to balance the delivery of all of its services is at the heart of ecosystem-based management. But, how can this balance be accomplished amidst the conflicting demands of stakeholders, managers, and policymakers? In marine ecosystems, several common ecological mechanisms link biodiversity to ecosystem functioning and to a complex of essential services. As a result, the effects of preserving diversity can be broadly beneficial to a wide spectrum of important ecosystem processes and services, including fisheries, water quality, recreation, and shoreline protection.

A management system that conserves diversity will help to accrue more, eco-service capital for human use and will maintain a hedge against unanticipated ecosystem changes from natural or anthropogenic causes. Although maintenance of biodiversity cannot be the only goal for ecosystem-based management, it could provide a common currency for evaluating the impacts of different human activities on ecosystem functioning

and can act as a critical indicator of ecosystem status. Significant advances in techniques and technologies have been made in recent years in to reduce environmental impacts, like the Environmental Management System (EMS) under ISO 14000. The following sections provide the management plans to be implemented for conserving the water quality, sediment and marine biodiversity of the intertidal region within and the immediate vicinity of the proposed project.

### **Objectives of MBMP**

- To identify the anticipated environmental issues which can affect marine water quality and marine biota during construction and operational periods of the proposed project.
- To provide guidelines and procedures for implementing mitigation measures.
- Develop an institutional framework for marine environmental and biodiversity management.
- Take immediate action when unpredicted impacts occur.
- Monitor the effectiveness of mitigation measures.
- Implementation of environmental sustainability in jetty.

### **6.2. Components of Marine Biodiversity and Environment Management Plan**

The anticipated marine environmental impacts on the prevailing marine water quality and biodiversity and mitigation measures for reducing the environmental impacts of the proposed jetty project have been discussed in detail in Chapter 5.

The following specific marine biodiversity and environmental management aspects are discussed in this section:

- Summary of project activities, associated impacts and mitigation measures in the marine sector
- Priority sites identified around the port for marine biodiversity management
- Institutional arrangements for marine environmental management

- Mechanism for implementation of mitigative measures in the marine segment
- Approach towards voluntary compliance
- Management sections cover under MARPOL
- Legal framework
- Cost of Marine Environment Management Plan
- Marine Environment Monitoring During Construction and Operational Phase
- Disaster Management Plan (DMP)
- Environmental sustainability in jetty

Table 6.2.1: Proposed development activities, associated impacts and mitigation in a nutshell

No.	Jetty activities	Marine compartment likely to affect	Impacts on the marine environmental if no mitigation measures are implemented	Mitigation measures	Responsible agency for implementation
Construction Phase					
1.	Jetty Infrastructure, Piling Works and pipeline installation	Marine biota	Decrease in primary productivity  Decrease in zooplankton biomass  Benthic biota loss  Noise related issues	<ul style="list-style-type: none"> <li>✦ Ensure dumping of excess/unusable piled material at designated place onshore</li> <li>✦ Discharge of waste into the sea is strictly prohibited</li> <li>✦ Implementation of oil spill control SOPs</li> <li>✦ Slop tanks on barges and boats for collection of liquid, solid and hazardous waste</li> <li>✦ Minimize the spill on the marine environment</li> </ul>	PLL/assigned contractor

2.	*Solid, liquid and hazardous waste handling	Marine water and sediment quality	Impact on marine water, sediment and biota due to waste disposal	<ul style="list-style-type: none"> <li>✦ Proper collection of waste generated at the worksite and its disposal as per GPCB and CPCB norms</li> <li>✦ Adoption of safety measures as per OSHA Standards</li> <li>✦ Hazardous materials such as oils, paints, compressed gases etc will be stored as per the approved safety norms</li> <li>✦ Medical facilities including first aid will be made available for the workforce.</li> </ul>	PLL/assigned contractor
		Marine biota	Toxicity from hazardous chemicals		
<b>Operational Phase</b>					
1.	Shipping operation	Marine water, sediment quality and biota	Releasing of ship waste	<ul style="list-style-type: none"> <li>✦ Vessels visiting the port shall meet emission standards as per MARPOL 73/78</li> <li>✦ Vessels are prohibited from discharging any form of wastewater, bilge, oil wastes etc. into the near-shore as well as harbour waters</li> </ul>	PLL/assigned contractor
		Accidental spillage and leaks of cargo handling			
		Noise and light	Noise and light		



			pollution on marine mammals and birds	<ul style="list-style-type: none"> <li>✦ Ships would comply with the MARPOL convention</li> <li>✦ As LNG ships runs on Boil Off Gas (BOG) generated in cargo tanks and LNG being a clean fuel, there are no major gas emissions</li> <li>✦ Comprehensive and easy to implement Standard Operating Procedure (SOP) will be made for each category of cargo to avoid spillages</li> </ul>	
		Air quality	Regional air pollution (SOX, NOX, PAH, VOCS, PM etc) from vessels		
2.	LNG Spill	Marine biodata-intertidal region	Impact on marine biota due to change in temperature	<ul style="list-style-type: none"> <li>✦ Ship and terminal safety/security system- tanker standoff protection system.</li> <li>✦ Powered Emergency Release Coupler (PERC) installed between double block valves to allow quick arm disconnection during emergency.</li> <li>✦ No flange connections</li> </ul>	PLL

### **a. Site-specific Marine Biodiversity Management**

Cumulative impacts due to construction of the proposed jetty can pose a considerable threat to the biodiversity present in these ecosystems. Destruction of marine biota is considered a loss to biodiversity and resource depletion. Due to the presence of different mud crab and mudskippers diversity, the environmental cell of the proposed jetty can plan and monitor Dahej area as a site for long term biodiversity monitoring which will eventually lead to the conservation of that area.

Threats to the biodiversity priority areas can be minimized with strict implementation of mitigatory measures proposed (Chapter 5) for each type and stage of activities related to the proposed port development. Adopting a proper management plan for solid waste and oil pollution will help to conserve these locations. For the long term conservation of these eco-sensitive sites, PLL and its environment cell may implement some activities like regular monitoring of these sites, scientific research, eco-restoration and conservation activities of degraded sites and organize public awareness and education programmes.

### **b. Community/stakeholder involvement in conservation activities**

Scientific information and knowledge about the current status of biodiversity, values associated with it and necessary conservation methods will be communicated to the public/stakeholders. Important aspects to be covered under this are given below:

- Importance of natural biodiversity and ecosystem functions and linkages with human survival and well-being
- Biodiversity conservation should be the common aim for ecosystem-based management for all agencies involved in the marine environment
- Setting up objectives for local stakeholders to improve the biodiversity by applying traditional conservation practices
- Maintaining a healthy relationship between port authorities and local stakeholders

- Practicing good governance and sustainable ecosystem management practices involving local participation and transparency
- Conducting outreach programmes and workshops for stakeholder knowledge improvement and conservation of marine life

PLL through its environmental team may provide financial support fully/partially as part of their CSR activities.

### c. Institutional arrangements for marine environmental management

Institutional arrangements for marine management of the environment fall under the broad categories of project monitoring and post-project monitoring; inspections of machinery; solid, liquid and hazardous waste management; ballast water management; implementation of MARPOL73/78; Identify environmental aspects for normal, abnormal and emergency conditions; structures and pollution combating equipment; petroleum spill control and combating; ensure implementation of standard operating procedures; evaluate any non-conformity to the environmental standards and green belt development. For this purpose, PLL may help in addressing the environmental related issues on the marine segment. The model structure for the environment management cell is given below:

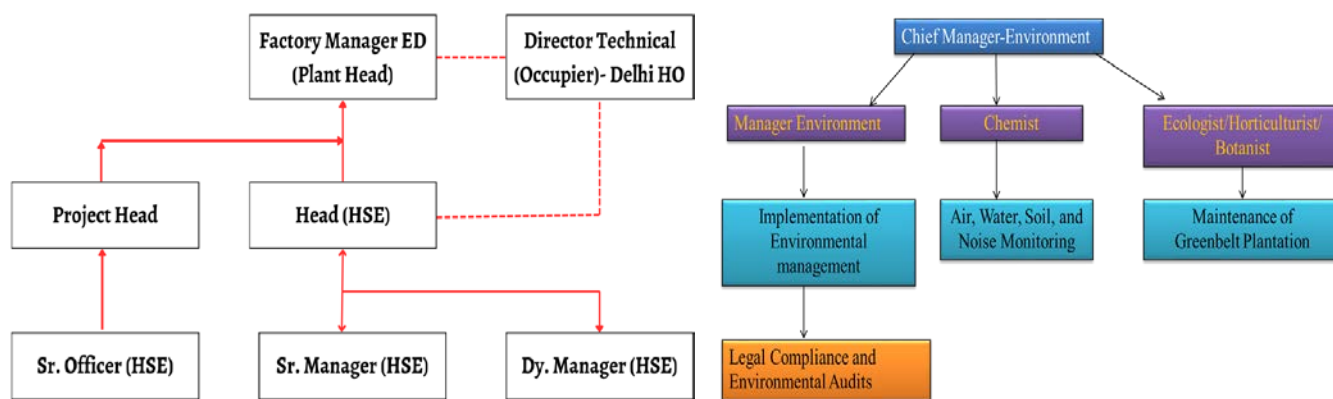

Apart from these routine monitoring and inspections, EMC should be responsible for arranging training programmes, refresher courses, mock rehearsals etc. The records of all these activities should be maintained as a part of the overall record system. The proposed port should have an operational Tier-I Oil Spill Contingency Plan approved by the Indian Coast Guard, which is designed to deal with Tier-I oil spillage and to provide guidance for the initial response to Tier-II and Tier-III oil spills. The plan details the contingency arrangements for responding to actual or threatened oil pollution incidents at the port.

**d. Mechanism for implementation of mitigative measures in the marine segment**

For an efficient implementation and supervision of marine environmental and biodiversity management and to mitigate the environmental impacts, which are likely to arise due to the various phases of construction and during the operational phases of the proposed jetty can be achieved through a well-organized institutional mechanism.

Implementation of appropriate marine environmental management plans and SOPs during different work stages is a requirement for the overall success of environment management. The persons assigned to this task should put up the various institutional arrangement needed for the implementation of effective environmental mitigative measures. Existing in-house Environment Management Cell of PLL can take the lead in these aspects of environmental issues.

**e. Approach towards voluntary compliance**

PLL should successfully implement Environment, Health & Safety Management System (EHS MS) based on recognized international standards for environmental and safety management systems like ISO 14001, OHSAS 18001, Social Accountability (SA) 8000 and International Maritime Organization (IMO) and MARPOL 73/78 guidelines. The main objective behind this is to place a system to assess, monitor and manage various environmental performances in the field of marine, land, air, water, soil and noise which

can lead to improve pollution prevention in these segments. Common procedures that can be adopted are given below:

- Identification of various environmental compartments and sensitive areas (classified under CRZ-I) and land, air and water which can be affected by the daily operation of the port
- Find out the major operations that have significant environmental impacts
- Implementation of environmental legislations and policies
- Charting timelines for achieving environmental and biodiversity management goals
- Frame an Environmental Management System
- Effective and proper implementation of these objectives is entrusted with PLL and its environmental management team.

#### **f. Management sections cover under MARPOL**

At an international level, various legal instruments and controls have been provided to encourage regulation and enforcement by flag states, coastal states and port state control. For example, the International Maritime Organization (IMO) convention on Marine Pollution MARPOL 73/78 outlines measures aimed at completely eliminating the willful and intentional discharge into the seas of oil and noxious or hazardous substances, chemicals, packaging, sewage and garbage. Specifically Annexes I, II, III, IV, V and VI of MARPOL 73/78 identify these sources and by their provision, port authorities are obligated to provide reception facilities for the handling of a range of waste including oil, chemical and garbage. Ports are also required to produce a Port Waste Management Plan (PWMP), including information on the type and location of facilities, notification requirements, details of providers and costs. These plans are to be made available to port users, to ensure that vessels needs are met promptly with no undue delay.

All applicable guidelines are being followed by PLL.

## **g. Legal framework**

A number of rules and laws regulate activities on the Indian coast. India has regulatory agencies such as the Central Pollution Control Board (CPCB) at the central level and State Pollution Control Boards (SPCB) at the state levels, constituted under Water (Prevention and Control of Pollution) Act, 1974. The Aquaculture Authority of India has been constituted, and guidelines on sustainable aquaculture development for regulating coastal aquaculture have also been developed.

A National Contingency Plan has been formulated to combat oil spills in the EEZ of India with the Coastal Guard as the nodal agency. The disposal of ship-based wastes is regulated by the Merchant Shipping Act, 1958 and by the adoption of MARPOL 73/78. Standards for discharging effluents are listed in the Environmental Protection Act (EPA), 1986. This serves as an umbrella act providing for the protection and improvement of the environment including coastal and marine areas. The effluents/discharges from various resources have to meet these standards before being discharged into marine waters.

The Coastal Zone Regulation Notification was issued in 1991 in India, under the EPA, 1986. The Notification aims at protecting and improving the quality of the coastal environment. The Notification declares the limits of the Coastal Zone and classifies it into four categories for purpose of regulation. A state-wise Mangrove Committee has been formed for effective management of the mangrove ecosystem. Mining of corals and coral sands has been banned. The CRZ notification also offers protection to coastal communities such as traditional fishermen.

The Recycled Plastics Manufacture and Usage Rules, 1999; Municipal Solid Wastes (Management and Handling) Rules, 2000; Ozone Depleting Substances (Regulation) Rules, 2000; The Prevention and Control of Pollution (Uniform Consent Procedure) Rules, 1999, are some of the rules framed under EPA, 1986, with an aim to providing environmental protection and are relevant to the coastal environment. Since 1982, the

CPCB has been carrying out a rapid inventory annually to assess the pollution status of coastal waters of India. This programme known as the Coastal Pollution Control Series (COPOCS), comprises among other things; a) Identification of the uses of coastal water at different stretches and the best use among them; class designation of the sector or a portion thereof, and b) Identification of land-based pollutants and polluting activities and those that require immediate control.

Efforts have been made to set up sewage treatment plants in all coastal states. Treated effluents are being discharged into deeper waters through pipelines. The Government is also preparing an action plan for treatment of domestic wastes. Legislation has helped in the treatment of industrial wastes. In India, the Water (Prevention and Control of Pollution) Act includes tidal waters, unlike some other countries. The Act is applicable up to 5 km into the sea. Though the discharge of effluents from small scale industries is still a problem, efforts are being made to set up common treatment plants. This will help in minimizing the load that is discharged to the sea.

The Indian Coast Guard is empowered to prevent capture of endangered marine species under the Wild Life (protection) Act, 1972. A number of threatened marine species have been placed in the Wild life (Protection) Act, 1972. Some of these are the whale shark, sea horse, sea cucumber, sea shells and different types of corals. The most important of these is the whale shark.

To prevent over-exploitation of fish stocks and protect the interests of coastal communities, the following legislation/rules/acts are in force in the country.

The Maritime Zones of India (Regulation of fishing by Foreign Vessels) Act, 1981 provides regulations for foreign fishing vessels operating in Indian waters. The Coast Guard and the State/UT Police has been authorized under the Act to apprehend and prosecute unauthorized foreign fishing vessels/crew for fishing/poaching in Indian waters.

Consistent with the guidelines contained in the Marine Fishing Regulation Act (MFRA), 2003 and amendment, 2020, which is a model act, providing guidelines to the maritime states, legislations have been enacted and enforced for regulating fishing and conservative measures in territorial waters. Such state enactments provide for regulation of mesh size to avoid catching juvenile fish, regulation of gear to avoid over exploitation of certain species, reservation of zones for various fishing sectors to provide exclusive rights to traditional fishermen to fish unhindered in near-shore areas and also for declaration of closed seasons during the fish-breeding period to avoid catching of young juvenile fish.

India also is actively involved in the Intergovernmental Oceanographic Commission, UN Convention on the Law of the Sea, Antarctic Treaty System, and the UNEP Regional Seas Programme. Scientific and technical bilateral cooperation with other nations, e.g. Russia, Germany, The Republic of Korea, Argentina, Peru, Italy and others, has been established. India has also ratified the International Convention for the Prevention of Pollution from Ships (MARPOL Convention 73/78). Some of the other international conventions on environment ratified by India are the International Convention for the Regulation of Whaling, International Plant Protection Convention, 1951, Convention on Facilitation of International Traffic, 1965, International Convention on Load lines, 1966, International Convention on Tonnage Measurement of Ships, 1969, International Convention on Civil Liability for Oil Pollution Damage, 1969, Special Trade Passenger Ships Agreement, 1971, International Convention on Establishment of an International Fund for Compensation for Oil Pollution Damage, 1971, Convention on the International Regulations for Preventing Collisions at Sea, 1971, as amended (COLREG 1972), International Convention of Safe Containers, 1972, Convention on International Trade in Endangered Species of Wild Fauna and Flora, 1973, International Convention for the Safety of Life at Sea, 1974, Framework Convention on Climate Change, 1992, Convention on Biodiversity, 1992. India is also a signatory to the Convention of Wetlands of International Importance, protocol of 1978 relating to the International



Convention for the Prevention of Pollution from Ships, Vienna Convention for the Protection of the Ozone Layer, Convention on Migratory Species, Basel Convention on Trans-boundary Movement of Hazardous Substances, Montreal Protocol on Substances that Deplete the Ozone Layer.

All the acts with existing acts/rules with their salient features are given in Table 6.2. The Table 6.2 shows the conventions and international treaties to which India is signatory. Considering all the rules/regulations/laws/acts/treaties, the following management plan yields best possible practices in the industry.

Table 6.2.2: The existing act/rules and their salient features

Existing Act/Rules	Salient Features
Environment Protection Act (EPA), 1986.	For the purpose of protecting and improving the quality of the environment and to prevent environmental pollution.
Coastal Regulation Zone Notification, 1991.	Regularizes the various activities in coastal zone.
Coastal Zone Management Plans (CZMPs).	
Hazardous Waste Management Act, 1989.	All coastal States and Union territory administrations shall update their respective CZMPs (which was prepared based on the CRZ Notification 2011), as per the provisions contained in the CRZ Notification, 2019.
Environmental Impact Assessment Notification, 1994 & 2006.	This Act provides guidelines for hazardous waste management and also for the import and export of hazardous waste in Country.  The objective of this Act is to conserve and protect the environment.

Water (Prevention and Control of Pollution) Act, 1974, Amended in 1988.	One of the essential provisions of the Water Act, 1974, is to protect and restore the welfare of our water supplies. Prevention and control of water pollution and maintaining or restoring of wholesomeness of water. The central and state pollution control board have been constituted under section 3 and 4 of the water Act respectively.
Indian Ports Act, 1908.	Enactment relating to ports and port charges. Provides for rules for the safety of shipping and conservation of ports.
Major Port Trust Act, 1963.	The Act makes provision for the constitution of port authorities for certain major ports in India and to vest the administration, control and management of such ports in such authorities and for matters connected therewith.
The Major Port Authorities Act, 2021.	An Act to provide for regulation, operation and planning of Major Ports along India coastline and to vest the administration, control and management of such ports upon the Boards of Major Port Authorities and for matters connected therewith or incidental thereto.
Merchant Shipping Act, 1958.	Control of pollution from ships and off-shore platforms.

Coast Guard Act, 1978.	An Act to provide for the constitution and regulation of an Armed Force of the Union for ensuring the security of the maritime zones of India with a view to the protection of maritime and other national interests in such zones and for matters connected therewith.
Maritime Zones Act, 1976.	Describes various zones such as territorial waters, EEZ, Continental shelf and maritime zones of India.
Forest Conservation Act, 1980, Amended in 1988.	Protection act providing for forest conservation.
Wildlife Protection Act, 1972 (Amended in 1983, 1986, 1991, 1997, 2001).	Offers protection to marine biota. Creates conditions favorable for in site conservation of fauna and flora. Amended in 2001 to include several species of fish, corals, sea cucumbers, sea shells and whale shark.
Indian Fisheries Act, 1897.	Offers protection to fisheries against explosives or dynamites.

<p>Marine Fishing Regulation Act, 2003 &amp; Amendment, 2020</p>	<p>A model act, which provides guidelines to the maritime States to enact laws for protection to marine fisheries by regulating fishing in the territorial waters. The measures include: regulation of mesh size and gear, reservation of zones for various fishing sectors and also declaration of closed seasons. Laws framed and amended from time to time by different maritime States.</p>
<p>National Environmental Tribunal Act, 1995.</p>	<p>This has been created to award compensation for damages to persons, property and the environment arising from any activity involving hazardous substances.</p>
<p>The National Environment Appellate Authority Act, 1997.</p>	<p>Addresses appeals with respect to restrictions of areas in which classes of industries are carried out or prescribed subject to certain safeguards under the EPA. The objective is to bring in transparency and accountability and to ensure the smooth and expeditious implementation of developmental schemes and projects.</p>
<p>Biodiversity Act, 2002.</p>	<p>The Act that has been passed, with an aim to protect and conserve biodiversity and sustainable use of its components.</p>

Table 6.2.3: Convention to which India is a signatory

United Nations Convention on the Law of the Sea (UNCLOS), 1982.	Law of the sea treaty.
Basel Convention, 1992.	The Basel Convention contains specific provisions for the monitoring of hazardous waste. A number of articles in the convention oblige parties (national governments which have acceded to the convention) to take appropriate measures to implement and enforce its provisions, including measures to prevent and punish conduct in contravention of the convention.
Ocean Policy Statement	Sets out basic principles through which the development of ocean is to be carried out.
Convention on Migratory species	Convention gives protection to many species of crocodiles, sharks, turtles, etc.
Maritime Pollution (MARPOL) 73/78	Disposal of ship-based wastes. Minimization of ocean and sea pollution including waste, oil emissions and air pollution.
International Union for Conservation of Nature (IUCN)	For influence, encourage and assist the global societies to preserve and conserve nature. They also ensure that the natural resources are used sustainably.

---

Ramsar

Provides the framework for national action and international cooperation for the conservation and wise use of wetlands and their resources.

---

### 6.3. Cost of Marine Environmental Management Plan

The proposed item-wise break-up of various activities of EMP is listed below. The list is not exhaustive, it gives a broad idea of the various items for which funds need to be allocated in the cost estimate of an MEMP. The funds to be allocated for the various heads are given below:

<b>Marine Environmental Monitoring (Involvement of third party monitoring)</b>	
Water, sediment quality and marine biota	Rs. 25 lakhs annually

### 6.4. Marine Environmental Monitoring During Construction and Operational Phase

#### Baseline studies

As a first important step towards the maintenance of the health of the marine ecology of the study area, critical locations are to be carefully selected around the project as monitoring sites for periodic health checks with respect to water quality, sediment quality and flora and fauna. The results presented in this report are adequate to identify the monitoring sites. The parameters to be monitored are listed below.

**i) Water Quality:** Water samples near-surface and bottom for temperature, pH, SS, salinity, DO, BOD, dissolved phosphate, nitrate, nitrite, ammonia phenols and Petroleum hydrocarbons.

**ii) Sediment Quality:** Sediment from sub-tidal and intertidal regions to be analysed for heavy metals, organic carbon, texture and petroleum hydrocarbons.

**iii) Flora and Fauna:** Biological characteristics are to be assessed based on primary productivity, phytopigments, phytoplankton populations and their generic diversity, biomass, population and group diversity of zooplankton, biomass, population and group diversity of benthos, fishery diversity, mangrove diversity & assessment and regular monitoring around the port area.

**iv) Assessment:** The results of each monitoring should be carefully evaluated to identify changes if any, beyond the natural variability identified through baseline studies. Gross deviation from the baseline may require a thorough review of operations at the jetty to identify the causative factors leading to these deviations and accordingly, corrective measures to reverse the trend will be necessary.

A comprehensive marine quality-monitoring program with periodic investigations at predetermined locations (8-10) by a competitive agency is a practical solution to ensure quality data acquisition. This can be a continuation of the study designed for baseline quality. The parameters listed in the baseline study are to be included in the post-project monitoring program. The results of each monitoring should be carefully evaluated to identify changes if any, beyond the natural variability identified through baseline studies.



Table 6.2.4: A Monitoring Framework

Sr. No.	Project activity/stage	Monitoring indicator	Frequency	Responsibility
1.	Construction	Noise during construction	Once-during construction machinery specification	PLL and assigned contractor
		LNG spill containment and spill cleanup	Once-Built-in product specification	PLL
		Sewage disposal system	Once-to be kept in specification	PLL
		Fire prevention and fire protection equipment monitoring	Once- to be kept in specification	PLL
		Hazardous material management plan	Once- to be kept in specification	PLL
		Sediment quality and marine biota of intertidal area	Once in six month	PLL and assigned contractor
2.	Operation and maintenance	Effectiveness of training programs and plan	Once in a year	PLL

		Water, sediment and marine biota	Once in a year	PLL and assigned contractor
--	--	----------------------------------	----------------	-----------------------------

**6.5. Disaster Management Plan (DMP)**

Disaster is an unpleasant sudden event of such a magnitude that may cause extensive damage to life or property due to natural calamities like an earthquake, flood, cyclones, landslides, lightning etc. The purpose of DMP is to give an approach to detailed organizational responsibilities, actions, reporting requirements and support resources available to ensure effective and timely management of emergencies.

**Purpose of Disaster Management Plan**

Design contingency plan, taking into account the accident scenario and natural disasters.

- Safeguard personnel to prevent injuries or loss of life by protecting them from the hazard and evacuating from the site on short notice.
- Obtain early warning of emergency conditions so as to prevent impact on personnel, assets and environment.
- Ensure safety of people, protect the environment and safeguard commercial considerations.
- Ensure immediate response to an emergency situation with an effective communication network and organized procedures.
- Provide guidance to help stakeholders to take appropriate action to prevent accidents and to mitigate adverse effects of accidents that do nevertheless occur.
- Minimize the overall impact of the event at the jetty.

## 6.6. Disaster Management Cycle

The Disaster Management Cycle (DMC) has a significant role to play. The four stages of the disaster management cycle have their own importance in terms of their implementation during, after and before the occurrence of any disaster.

**a) Mitigation:** Mitigation activities actually eliminate or reduce the probability of disaster occurrence, or reduce the effects of unavoidable disasters. Mitigation measures include OSHA standards, SOPs, MARPOL regulations, building codes; vulnerability analyses updates; zoning and land use management; building use regulations and safety codes; preventive health care; and public education.

**b) Preparedness:** The goal of emergency preparedness programs is to achieve a satisfactory level of readiness to respond to any emergency situation through programs that strengthen the technical and managerial capacity of governments, organizations, and communities. These measures can be described as logistical readiness to deal with disasters and can be enhanced by having response mechanisms and procedures, rehearsals, developing long-term and short-term strategies, public education and building early warning systems. Preparedness can also take the form of ensuring that strategic reserves of food, equipment, water, medicines and other essentials are maintained in cases of national or local catastrophes.

**c) Response:** The aim of emergency response is to provide immediate assistance to maintain life, improve health and support the morale of the affected population. Such assistance may range from providing specific but limited aid, such as assisting refugees with transport, temporary shelter, and food, to establishing semi-permanent settlement in camps and other locations. It also may involve initial repairs to damaged infrastructure. The focus in the response phase is on meeting the basic needs of the people until more permanent and sustainable solutions can be found. Humanitarian organizations are often strongly present in this phase of the disaster management cycle.

**d) Recovery:** As the emergency is brought under control, the affected population is capable of undertaking a growing number of activities aimed at restoring their lives and the infrastructure that supports them. There is no distinct point at which immediate relief changes into recovery and then into long-term sustainable development. There will be many opportunities during the recovery period to enhance prevention and increase preparedness, thus reducing vulnerability. Ideally, there should be a smooth transition from recovery to on-going development.

PLL possess a well-planned and note-worthy Emergency Response and Disaster Management Plan and is in practice at all levels. The ERDMP is a master plan, which contains the emergency organization structure, responsibilities of key members, communication means and emergency response strategies to control a range of major incidents. The plan has been developed after a complete analysis and assessment of various risks associated with the ship unloading operation at jetty and process and storage of various chemicals inside the terminal. Each key member has his own plan describing detailed activities to function effectively in the emergency management.

### **6.7. Environmental Sustainability in jetties**

Due to the problems of climate change as well as the increasing requirements for the logistics and transportation industry, environmental sustainability has become one of the key cornerstones on the agenda of many maritime ports. The environmental impacts are quite significant, especially due to the various sources and forms of jetty-related emissions, such as those from seagoing vessels, heavy-duty trucks, and cargo-handling equipment. Apart from that, the jetty community consists of various actors and stakeholders with different perspectives and interests in terms of environmental sustainability.

The term environmental sustainability describes a broad concept, it is important to first identify key areas in this context. There are six core areas comes in this category. First,

environmental objectives, pursuing a green strategy, as well as performance indicators, measuring the success of management efforts, need to be defined. The green strategy takes stakeholder interests, public policies and regulations, and social responsibility into account. Given this foundation, various practices and instruments exist to achieve various environmental objectives. Continuous improvement can be obtained by auditing, measuring, and monitoring the progress as a feedback function on the one hand, and by facilitating an alignment between the strategy, projects, operations, and technology. Thereby, new technological developments and advancements in the jetty infrastructure, for instance, may create new opportunities for adapting port strategies, business models, and operations.

### **Environmental Objectives**

A clear definition of strategic objectives is required to determine a coherent green strategy in accordance with the overall jetty strategy, stakeholder interests, external regulations and policies, and social responsibility.

➤ **Landlord function:** This involves the management of jetty-related areas and activities in a way that negative environmental effects are mitigated. Environmental implications must be considered in jetty related decisions and actions, such as the selection and management of tenants, infrastructure and construction, master planning, dredging, and connectivity (e.g., hinterland transport).

➤ **Regulatory function:** This subsumes controlling, auditing, and policy functions to not only ensure safety and security within the port but also environmental protection. The latter involves the regulation of environmental matters as well as implementation, monitoring, and sanctioning in case environmental requirements are not fulfilled.

➤ **Operator function:** This traditionally covers the provision of jetty services with respect to the physical transfer of goods and passengers between sea and land, the provision of technical-nautical services (pilotage, towage, and mooring) and a range of ancillary services. In this regard, the jetty needs to ensure that the environmental impact is minimized, such as by improving energy efficiency and conservation, as well as when selecting and managing subcontractors.

➤ **Community manager function:** A coordinating function for stakeholder management and for maintaining good relationships within the jetty community. Regarding this role, the jetty needs to facilitate environmental awareness, stimulate and ensure the adoption of green practices, coordinate environmental activities, and increase the visibility of the green efforts within the jetty and in public.

## **6.8. Environmental performance indicators**

To measure, monitor, and report the performance and trends of environmental activities, resulting from the implementation of a green strategy, environmental performance indicators must be specified. Measuring and reporting those indicators serve as a feedback loop for berth (jetty) governance and management. A comprehensive set of indicators for maritime ports falls under the categories of environmental indicators specified in ISO 14031, the indicators are grouped as follows.

➤ **Management performance indicators (MPIs):** A set of indicators devoted to evaluating the efforts made by the port towards the implementation of an environmental management system (EMS) which is used to organize and manage environmental programs in the port. This involves, for example, indicators to assess the implementation of processes for auditing, monitoring, budgeting, training and awareness, communication, and emergency planning.

➤ **Operational performance indicators (OPIs):** Allow the assessment of port operations in terms of resource consumption, noise, waste management, and port development.

➤ **Environmental condition indicators (ECIs):** These indicators are used to measure and analyze the quality and state of environmental conditions, such as with respect to the quality of air (e.g., regarding GHG emissions like CO<sub>2</sub>, SO<sub>x</sub>, NO<sub>x</sub>), water, soil, and sediments. Indicators to show the status of specific flora and fauna species are also contained in this category.

## 6.9. Policies and regulations

A port policy can be regarded as an essential governance instrument for implementing green objectives and regulating port activities of individual actors. As environmental policies and regulations may impose substantial costs, a balance between environmental quality and economic feasibility must be sought. The government is responsible for making public policies and regulations at the local, regional, national, and supranational level, whereas the national authorities are, in some cases, the local enforcement authority of international conventions, such as regarding IMO (International Maritime Organization) conventions. Group policy measures for establishing a “green transport corridor” according to related incentives.

➤ **Economic incentives:** To promote energy-efficient transport, better utilization of resources, and the use of advanced environmental technologies. Common examples include tax incentives, extended gate hours, pricing strategies such as port due discounts for eco-friendly ships, penalizing and restricting access to ports, and financial incentives for modal shifts.

➤ **Legal incentives:** Regulations that hinder unwanted intensive transport activities or reduce/ban polluting technologies in certain areas (e.g., low emission zones, emission

control areas), e.g., to improve access for other port actors. Examples include the Clean Truck Program in US ports (e.g., Port of Los Angeles and Long Beach) and the application of specific access rules for trucks in the Port of Rotterdam (Netherlands), where only trucks with certain emission standards can enter.

➤ **Supporting incentives:** Involves investments and grants for promoting the adoption and development of eco-friendly infrastructure, procedures, and technologies. Examples are truck replacement programs to facilitate the use of clean energy engines. This may also include investments in infrastructure (e.g., equipment for cold ironing, clean bunkering and renewable energy) and information technology. An example is the Maritime Singapore Green Initiative (MSGI), which has provided huge grants within several programs for reducing the environmental impact of port-related activities.

➤ **Voluntary incentives:** By participating in voluntary programs, companies may benefit from better public perception and might get free access to technical innovations and best practices. Often, policy-makers use voluntary incentives to test potential policies, which may reduce the transition time for participants in case the policy is implemented.

## **6.10. General management practices**

Ports have been early adopters of EMS as a systematic approach to manage and certify port operations. Taking into account well-defined standards and performance indicators, the overall goal is to enhance the environmental performance, fulfillment of compliance obligations, and achievement of environmental objectives (ISO 14001). Eco Ports has developed a basic EMS designed to facilitate the environmental certification and specifically adapted to the needs of maritime ports. It is built from elements of the ISO 14001 system, facilitates environmental certification, and can be implemented by applying the port environmental self-diagnosis method (SDM) and implementing the port environmental review system (PERS), allowing the port to apply for a certificate. An



environmental management information system (EMIS) further supports the management in obtaining, processing, and distributing relevant environmental information in response to internal and external requirements (e.g., regulations, policies, and stakeholder interests). Environmental risk analysis is another responsibility of ports to identify, assess, and prioritize risks associated with environmental duties and liabilities for environmental damage. As seen in Europe, a mutual collaboration between the port sector, research institutes, and specialist organizations fully supported by the ESPO, has paved the way for an improved concept of port environmental management. Moreover, an international working group, in collaboration with the International Association of Ports and Harbours (IAPH) and the World Association for Waterborne Transport Infrastructure (PIANC), is working on guidelines for sustainable reporting.

#### **6.11. Infrastructure and technologies**

The improvement of port infrastructure and the use of innovative port technologies can lead to enormous energy savings and reduced emissions. This includes energy-efficient vehicle and handling technologies, such as battery-powered automated guided vehicles (AGVs) or electric rubber-tired gantries, as well as the development of an improved transport infrastructure using intelligent transportation systems (ITSs) to mitigate traffic congestion and facilitate intermodal transportation. The environmental impacts of infrastructure projects, such as regarding dredging activities and techniques need to be considered.

#### **6.12. Planning and optimization**

Besides adapting port governance and management practices and investing in innovative infrastructure and technologies, an enormous potential for making port operations more eco-efficient lies in the consideration of environmental aspects while planning and optimizing port operations and activities. This not only involves the internal activities of individual port actors, but also the coordination and collaboration among

different actors along the logistics chains. Mitigating the environmental impact means explicitly considering ECIs in the planning and optimization phase. To reduce energy consumption and better utilize available resources, several concepts have been introduced in recent years regarding landside operations, for example, the implementation of gate/truck appointment systems. Moreover, slow steaming and the management of vessel arrivals for reducing the fuel consumption of seagoing vessels. Decision-makers usually cannot only take environmental objectives into account; often, a good trade-off between economic and environmental goals needs to be found, leading to multi criteria decision problems. Gaps in the theoretical deviation and implementation of multi objective decision support systems in maritime logistics, taking into account environmental sustainability, has to be identified for every ports for a more greener and sustainable port operations.

## DISCLOSURE OF CONSULTANTS

CSIR-National Institute of Oceanography; a constituent laboratory of the Council of Scientific & Industrial Research under Ministry of Science and Technology, Government of India; is a premier oceanographic research institute of the country. Institute has the necessary expertise supported by equipment and infrastructural facilities to carry out the marine survey and EIA studies. Consultants worked in this project are the regular staff of CSIR-NIO and are listed below.

<b>Name of Consultant</b>	<b>Specialization</b>	<b>Nature of consultancy rendered</b>
Dr. Abhay B. Fulke	Marine Microbial Ecology and Molecular Biology	Project leader and coordinated the work components related to water and sediment microbial analysis.
Dr. Haridevi C.K.	Biological Oceanography, Phytoplankton and Ecology	Associate project leader and coordinated the work related to phytoplankton analysis.
Dr. Umesh K. Pradhan	Chemical Oceanography and Marine Pollution	Associate project leader and coordinated the work components related to water and sediment physico-chemical analysis.
Dr. Soniya Sukumaran	Biological Oceanography, Benthic Biodiversity and Ecology	Team member, coordinated work related to benthic ecology analysis.
Dr. Rakesh P. S	Biological Oceanography, Marine Pollution and Eco- toxicology	Team member, coordinated work related to zooplankton parameters.
Dr. Sabysachi Sautya	Biological Oceanography, Benthic Biodiversity and Ecology	Team member, coordinated the work components related to macro benthic and meio benthic ecology of the area.

## REFERENCES

American Public Health Association, (1970). Recommended procedures for the examination of sea water and shellfish. In: Recommended Procedures for the Examination of Sea Water and Shellfish pp. viii-105.

Burns, E. R., and Marshall, C (1965): Correction for chloride interference in the chemical oxygen demand test. Journal (Water Pollution Control Federation), 1716-1721.

Grasshoff K, Kremling K, Ehrhardt M, editors (1999): Methods of seawater analysis. John Wiley and Sons.

ICES (2000). Harris R., Wiebe P., Len, J., Skjoldal H R and Huntley M E. (Eds.), Zooplankton Methodology Manual, Academic Press, London, 684 pp.

Murphy, J.A.M.E.S. and Riley, J.P (1962): A modified single solution method for the determination of phosphate in natural waters. Analytica chimica acta, 27, pp.31-36.

Parsons T R., Malta Y., Lalli M. (1984).A Manual of Chemical and Biological Methods for Seawater Analyses. Pergamon Press, New York.

Patra, P., Mohandass, C., Chakraborty, P., & Seleyi, S. C. (2021). Biochemical responses of oysters in evaluating environmental quality of tropical Indian estuarine systems. Chemosphere, 278, 130338.

Preston S D and Summers R M (1997): Estimation of nutrient and suspended- sediment loads in the Patuxent River basin, Maryland, water years 1986-90: U.S. Geological Survey WaterResources Investigations Report 96-4175, 69 pp.

Subrahmanyam, R. (1946). A systematic account of the marine plankton diatoms of the Madras coast. In Proceedings of the Indian Academy of Sciences-Section B (Vol. 24, No. 4, pp. 85-197). Springer India.

Tomas, C. R (Ed.). (1997). Identifying marine phytoplankton. California: Academic Press.

UNESCO. (1978). A monograph on oceanographic methodology–Phytoplankton manual, S. Sournia (ed.) Paris, 337 p.

Table 4.1.1: Water quality at different monitoring stations off Dahej during October 2022.

Parameter (unit)	Level	L1	L2	L3	L4	L5	L6	L7	L8	L9	L10
		Avg*	Avg*	Avg*	Avg*	Avg*	Avg*	Avg*	Avg*	Avg*	Avg*
Temperature (°C)	S	28.6	29.0	29.8	28.0	29.5	28.0	28.5	28.5	28.2	27.5
	B	28.4	28.9	29.0	NC	29.0	27.0	NC	28.0	27.5	27.0
	AT	28.5	29.5	31.0	33.0	28.0	29.0	32.0	31.0	28.0	27.0
pH	S	7.9	7.7	7.9	7.8	7.9	7.8	7.8	7.9	7.9	7.9
	B	8.0	7.7	7.9	NC	7.9	7.8	NC	7.9	7.9	7.9
Salinity (PSU)	S	18.7	17.5	19.5	12.2	20.9	17.7	20.2	20.4	24.4	20.6
	B	20.8	22.8	20.8	NC	20.8	22.5	NC	21.8	24.6	20.4
SS (mg/L)	S	599	66	27	693	110	28	296	438	398	298
	B	5254	991	332	NC	1985	55	NC	7915	2056	3058
Turbidity (NTU)	S	564	18	9	57	187	4	244	418	299	224
	B	7110	138	578	NC	3816	34	NC	2680	1058	2473
DO (mg/L)	S	7.2	7.0	6.7	7.1	6.9	6.7	7.2	8.2	7.2	7.2
	B	6.6	6.4	4.2	NC	6.7	6.2	NC	6.8	6.9	6.6
COD (mg/L)	S	108	101	112	125	117	119	66	75	97	111
	B	133	105	119	NC	145	101	NC	59	73	131
BOD (mg/L)	S	1.1	2.5	0.6	3.7	3.0	0.7	3.7	1.9	2.6	2.3
	B	1.1	1.9	1.1	NC	2.3	0.5	NC	4.4	3.2	3.4
NO <sub>3</sub> <sup>-</sup> -N (µmol/L)	S	32.8	39.2	39.1	24.8	20.7	43.0	54.7	46.8	41.7	44.8
	B	27.8	35.4	7.6	NC	31.5	40.6	NC	32.3	30.5	34.3
NO <sub>2</sub> <sup>-</sup> -N (µmol/L)	S	0.1	0.2	0.1	0.5	0.1	0.2	0.2	0.1	0.1	0.2
	B	0.2	0.1	0.0	NC	0.4	0.1	NC	0.1	0.1	0.1
NH <sub>4</sub> <sup>+</sup> -N (µmol/L)	S	7.4	4.2	3.0	6.1	3.5	4.6	0.2	1.8	2.0	2.4
	B	5.6	3.5	6.5	NC	1.9	3.8	NC	1.9	0.7	1.6
PO <sub>4</sub> <sup>3-</sup> -P (µmol/L)	S	1.7	2.1	1.6	2.1	1.9	1.5	1.3	1.9	2.0	1.9
	B	1.7	1.7	1.8	NC	2.6	1.7	NC	2.1	2.0	2.1

S: Surface, B: Bottom, AT: Air Temperature in °C

[Avg\* represent mean values of the data measured in duplicate samples collected on the spot].

Table 4.2.1: Microbial count in surface water at Dahej during October 2022

Station	L1	L2	L3	L4	L5	L6	L7	L8	L9	L10
Type	Spot	Spot	Spot	Spot	Spot	Spot	Spot	Spot	Spot	Spot
TVC $\times 10^3$ (CFU/ml)	27	12	23	28	28	15	26	22	12	15
TC (MPN/100ml)	75	19	9	24	15	19	42	34	19	75
FC (MPN/100ml)	23	11	6	21	6	14	27	21	12	36
EC (CFU/ml)	NG	NG	3	1	1	2	1	NG	NG	1
SF(CFU/g)	NG	NG	1	1	1	NG	NG	NG	NG	NG

NG: No growth

Table 4.2.2: Range and average (parenthesis) of phytopigments in coastal waters Dahej during October 2022.

Station	Date	Time & Tide	Chlorophyll		Phaeophytin		Ratio	
			mg/m <sup>3</sup>		mg/m <sup>3</sup>			
			S	B	S	B	S	B
L1	16-10-2022	830	0.28	0.69	0.13	2.95	2.15	0.23
		F.Fld						
		1500	0.43	0.97	0.74	3.44	0.58	0.28
L2	19-10-2022	1000	0.47	0.20	0.15	0.09	3.13	2.22
		F.Fld						
		1505	0.36	0.34	0.19	0.98	1.89	0.35
L3	19-10-2022	1230	0.56	0.25	0.21	0.18	2.67	1.39
		Fld-Ebb						
		1245	0.55	0.22	0.20	0.12	2.75	1.83
L4	18-10-2022	620	1.01	*	1.03	*	0.98	*
		Ebb-Fld						
		800	0.94	*	0.03	*	31.33	*
		Ebb-Fld	2.05	*	0.42	*	4.88	*
		1000						
		Ebb-Fld	0.63	*	0.16	*	3.94	*
		1200	0.42	*	0.04	*	10.50	*
		F.Fld						
		1400	0.34	*	0.70	*	0.49	*
		Fld-Ebb	0.34	*	0.48	*	0.71	*
1600								
Fld-Ebb	0.09	0.12	0.16	0.11	0.56	1.09		
L5	13-10-2022	702	0.15	*	0.18	*	0.83	*
		F.Fld						
		850	0.14	0.14	0.07	0.17	2.00	0.82
		Fld-Ebb						
1050	0.14	0.14	0.07	0.17	2.00	0.82		
Fld-								



		Ebb						
		1250	0.16	0.35	0.08	0.41	2.00	0.85
		Fld-Ebb						
		1340	0.24	0.13	0.04	0.09	6.00	1.44
		Fld-Ebb						
		1355	0.31	0.34	0.16	0.51	1.94	0.67
		Fld-Ebb						
		1450	0.51	0.37	0.12	0.43	4.25	0.86
		F.Ebb						
		1650	0.20	0.24	0.01	0.00	20.00	ND
		Ebb-Fld						
<b>L6</b>	18-10-2022	1155	0.24	0.19	0.22	0.20	1.09	0.95
		F.Fld						
		1210	0.25	0.18	0.22	0.19	1.14	0.95
		F.Fld						
<b>L7</b>	15-10-2022	1400	0.64	*	0.05	*	12.80	*
		Fld-Ebb						
		1415	0.79	0.24	0.10	0.33	7.90	0.73
<b>L8</b>	15-10-2022	1140	0.23	0.65	0.07	2.44	3.29	0.27
		Fld-Ebb						
		1155	0.10	0.17	0.07	0.29	1.43	0.59
<b>L9</b>	15-10-2022	907	0.12	0.33	0.04	0.36	3.00	0.92
		F.Fld						
		922	0.12	*	0.06	*	2.00	*
<b>L10</b>	15-10-2022	714	0.05	0.47	0.21	0.65	0.24	0.72
		F.Fld						
		1600	2.72	*	0.34	*	8.00	*
		F.Ebb						

Table 4.2.3: Range and average (parenthesis) of phytoplankton population at different stations in coastal water of Dahej during October 2022.

Station	Date		Cell count		Total genera		Major genera	
			(no x 10 <sup>3</sup> Cells/l)		(no)			
L1	16-10-2022	Min.	0.1	0.4	5	3	<i>Synedra</i> sp.	<i>Cyclotella</i> sp.
		Max.	0.2	1.2	7	4	<i>Tolypothrix</i> sp.	<i>Synedra</i> sp.
		Avg.	0.2	0.8	6.0	3.5	<i>Gymnodinium</i> sp.	<i>Cymatosira</i> sp.
							<i>Nitzschia</i> sp.	<i>Coscinodiscus</i> sp.
L2	19-10-2022	Min.	50.0	0.6	6	3	<i>Nitzschia acicularis</i>	<i>Nitzschia</i> sp.
		Max.	50.0	8.0	7	3	<i>Pseudonitzschia</i> sp.	<i>Gymnodinium fuscum</i>
		Avg.	50.0	4.3	6.5	3.0	<i>Synedra</i> sp.	<i>Navicula distans</i>
							<i>Biddulphia mobiliensis</i>	<i>Thalassiosira</i> sp.
L3	19-10-2022		42.0	0.2	8	2	<i>Skeletonema costatum</i>	<i>Amphora</i> sp.
							<i>Pseudonitzschia</i> sp.	<i>Nitzschia</i> sp.
							<i>Oscillatoria</i> sp.	
							<i>Coscinodiscus centralis</i>	
L4	18-10-2022	Min.	26.0	*	9	*	<i>Merismopedia</i> sp.	*
		Max.	52.0	*	10	*	<i>Surirella</i> sp.	*
		Avg.	39.0	*	9.5	*	<i>Amphiprora</i> sp.	*
							<i>Amphora</i> sp.	*
L5	19-10-2022	Min.	50.0	0.6	6	3	<i>Nitzschia acicularis</i>	<i>Nitzschia</i> sp.
		Max.	50.0	8.0	7	3	<i>Pseudonitzschia</i> sp.	<i>Gymnodinium fuscum</i>
		Avg.	50.0	4.3	6.5	3.0	<i>Synedra</i> sp.	<i>Navicula distans</i>
							<i>Biddulphia mobiliensis</i>	<i>Thalassiosira</i> sp.
L6	19-10-		42.0	0.2	8	2	<i>Skeletonema</i>	<i>Amphora</i> sp.

	2022						<i>costatum</i>	
							<i>Pseudonitzschia</i> sp.	<i>Nitzschia</i> sp.
							<i>Oscillatoria</i> sp.	
							<i>Coscinodiscus centralis</i>	
<b>L7</b>	15-10-2022		10.0	*	4	*	<i>Navicula distans</i>	*
							<i>Gymnodinium</i> sp.	*
							<i>Pseudonitzschia</i> sp.	*
							<i>Synedra ulna</i>	*
<b>L8</b>	15-10-2022		0.7	0.6	4	3	<i>Amphora</i> sp.	<i>Navicula transitans</i>
							<i>Gymnodinium fuscum</i>	<i>Amphora</i> sp.
							<i>Nitzschia longissima</i>	<i>Ceratium furca</i>
							<i>Surirella striatula</i>	
<b>L9</b>	15-10-2022		0.3	0.4	3	4	<i>Coscinodiscus</i> sp.	<i>Coscinodiscus</i> sp.
							<i>Lepocinclis</i> sp.	<i>Navicula</i> sp.
							<i>Navicula distans</i>	<i>Rhizosolenia setigera</i>
								<i>Thalassionema nitzschioides</i>
<b>L10</b>	15-10-2022	<b>Min.</b>	10.0	0.8	4	6	<i>Merismopedia</i> sp.	<i>Navicula</i> sp.
		<b>Max.</b>	150.0	0.8	10	6	<i>Nitzschia</i> sp.	<i>Nitzschia</i> sp.
		<b>Avg.</b>	80.0	0.8	7.0	6.0	<i>Synedra</i> sp.	<i>Coscinodiscus</i> sp.
							<i>Nitzschia acicularis</i>	<i>Nitzschia acicularis</i>

Table 4.2.4: Percentage composition of phytoplankton population at different stations in coastal waters of Dahej during October 2022.

Phytoplankton	Stations										Total Av.
	L1	L2	L3	L4	L5	L6	L7	L8	L9	L10	
<b>Diatoms</b>											
<i>Amphiprora</i> sp.				5.1	4.3						0.9
<i>Amphora</i> sp.			4.3	5.1	4.3	3.3		30.8			4.8
<i>Biddulphia mobiliensis</i>		3.3									0.3
<i>Biddulphia sinensis</i>			4.3		2.1	13.3					2.0
<i>Biddulphia</i> sp.										1.1	0.1
<i>Coscinodiscus centralis</i>			8.7			3.3					1.2
<i>Coscinodiscus</i> sp.	1.9								28.6	2.3	3.3
<i>Cyclotella</i> sp.	20.4										2.0
<i>Cymatosira</i> sp.	15.5										1.6
<i>Navicula transitans</i>		6.7	4.3	5.1	8.5		40.0	23.1	14.3	1.1	10.3
<i>Navicula</i> sp.	1.0			2.6	2.1				14.3	4.5	2.4
<i>Nitzschia acicularis</i>		41.7		5.1	4.3					6.8	5.8
<i>Nitzschia linearis</i>		1.7				6.7					0.8
<i>Nitzschia longissima</i>		3.3						15.4			1.9
<i>Nitzschia</i> sp.	8.7	5.0	8.7		6.4	3.3				29.5	6.2
<i>Pinnularia</i> sp.	1.9										0.2
<i>Pleurosigma</i> sp.				2.6	2.1						0.5
<i>Pseudo-nitzschia</i> sp.		10.0	21.7				20.0				5.2
<i>Rhizosolenia setigera</i>									14.3	1.1	1.5
<i>Skeletonema costatum</i>			30.4								3.0
<i>Surirella</i> sp.				10.3	12.8					1.1	2.4
<i>Surirella striatula</i>						3.3		7.7			1.1
<i>Synedra acus</i>				2.6	2.1						0.5
<i>Synedra</i> sp.	30.1	8.3		2.6	2.1					8.0	5.1
<i>Synedra ulna</i>		3.3					20.0			4.5	2.8
<i>Thalassionema frauenfeldii</i>		3.3									0.3
<i>Thalassionema nitzschioides</i>				5.1	4.3				14.3		2.4

<i>Thalassionema</i> sp.	1.0		4.3			3.3					0.9
<i>Thalassiosira</i> sp.		3.3									0.3
<i>Thalassiothrix</i> sp.										1.1	0.1
<b>Dinoflagellates</b>											
<i>Ceratium furca</i>								7.7			0.8
<i>Gymnodinium fuscum</i>		6.7						15.4			2.2
<i>Gymnodinium</i> sp.	9.7	1.7					20.0				3.1
<b>Chlorophytes</b>											
<i>Closterium</i> sp.		1.7									0.2
<i>Tetraspora</i> sp.				2.6	2.1						0.5
<b>Cyanophytes</b>											
<i>Merismopedia</i> sp.				41.0	34.0	53.3				36.4	16.5
<i>Oscillatoria</i> sp.			13.0	2.6	2.1	10.0				2.3	3.0
<i>Spirulina</i> sp.				2.6	2.1						0.5
<i>Tolypothrix</i> sp.	9.7										1.0
<b>Euglenophytes</b>											
<i>Lepocinclis</i> sp.									14.3		1.4
<b>Unknown</b>											
Unknown 1				2.6	2.1						0.5
Unknown 2				2.6	2.1						0.5

Table. 4.2.5: Range and average (parenthesis) of zooplankton at Dahej during October 2022.

Station (Date)	Biomass (ml/100m <sup>3</sup> )	Population (nox10 <sup>3</sup> /100m <sup>3</sup> )	Total Taxon (no.)	Major Taxon (%)
<b>L1</b> (16.10.2022)	1.7-3.2 (2.5)	5.4-16.9 (11.2)	20-22 (21)	Paracalanidae (57.8) Centropagidae (26.0) Chaetognatha (3.0) Temoridae (2.2) Acartiidae (1.9) Calanidae (1.6) Pontellidae (1.3) Candaciidae (1.2) Tortanidae (1.2) Ectinosomatidae (0.9) Eucalanidae (0.7) Longipediidae (0.6) Zoea(0.4) Lucicutiidae0.4) Mysis (0.3) Fish larvae (0.2) Pseudodiaptomidae (0.1) Mysidacea (0.1) Others (0.1)
<b>L2</b> (19.10.2022)	0.1*	0.2*	7-10 (9)	Paracalanidae (55.8) Ectinosomatidae (13.5) Calanidae (13.3) Chaetognatha (9.1) Gastropoda (3.4) Acartiidae (1.8) Polychaeta (1.1) Isopoda (0.9) Tachidiidae (0.6) Copelata (0.3) Zoea(0.2)
<b>L3</b> (19.10.2022)	0.1*	0.1-0.2 (0.2)	10*	Paracalanidae (55.3) Ectinosomatidae (25.5) Acartiidae (11.4) Chaetognatha (2.7)

				Gastropoda (1.6) Isopoda (1.4) Zoea(0.6) Fish eggs (0.4) Fish larvae (0.2) Others (1.0)
<b>L4</b> (18.10.2022)	No collection			
<b>L5</b> (13.10.2022)	0.4 – 3.9 (1.3)	0.7-16.6 (5.8)	14-19 (17)	Paracalanidae (50.9) Chaetognatha (13.3) Centropagidae (12.4) Zoea(5.7) Acartiidae (3.7) Pontellidae (2.5) Temoridae (2.0) Pseudodiaptomidae (2.0) Eucalanidae (1.7) Mysis (1.6) Ectinosomatidae (1.6) Longipediidae (0.8) Calanidae (0.7) Fish larvae (0.4) Mysidacea (0.2) Candaciidae (0.1) Tortanidae (0.1) Gastropoda (0.10) Others (0.1)
<b>L6</b> (18.10.2022)	0.1*	0.04 - 0.2 (0.1)	6-9 (8)	Ectinosomatidae (45.9) Paracalanidae (35.1) Acartiidae (4.1) Calanidae (4.1) Centropagidae (4.1) Chaetognatha (2.9) Isopoda (1.5) Zoea(1.1) Fish larvae (0.9) Fish eggs (0.3)
<b>L7</b> (15.10.2022)	No collection			

<p><b>L8</b> (15.10.2022)</p>	<p>0.7-8.0 (4.4)</p>	<p>4.2-53.8 (29.0)</p>	<p>14-15 (15)</p>	<p>Paracalanidae (67.9) Centropagidae (15.0) Zoea(7.2) Chaetognatha (5.6) Mysis (1.9) Pontellidae (0.7) Acartiidae (0.5) Calanidae (0.5) Candaciidae (0.2) Fish larvae (0.2) Pseudodiaptomidae (0.1) Euchaetidae (0.1) Others (0.1)</p>
<p><b>L9</b> (15.10.2022)</p>	<p>2.7-3.2 (3.0)</p>	<p>9.9-33.0 (21.5)</p>	<p>16-23 (20)</p>	<p>Paracalanidae (63.3) Centropagidae (12.2) Chaetognatha (9.6) Acartiidae (3.8) Pseudodiaptomidae (2.4) Euchaetidae (2.2) Calanidae (2.0) Zoea(1.8) Candaciidae (1.60) Fish larvae (0.3) Ectinosomatidae (0.2) Temoridae (0.2) Hydrozoa (0.2) Mysis (0.1)</p>
<p><b>#L10</b> (13.10.2022)</p>	<p>0.7</p>	<p>3.6</p>	<p>20</p>	<p>Paracalanidae (55.1) Centropagidae (15.2) Chaetognatha (13.2) Acartiidae (4.2) Pontellidae (3.4) Longipediidae (2.5) Pseudodiaptomidae (2.5) Temoridae (0.9) Tortanidae (0.9)</p>



				Zoea (0.6) Fish larvae (0.5) Mysidacea (0.4) Fish eggs (0.1) Polychaeta (0.1) Mysis (0.1) Gastropoda (0.1) Scyphozoa (0.1) Amphipoda (0.1) Others (0.1)
--	--	--	--	------------------------------------------------------------------------------------------------------------------------------------------------------------------------------------

\*Indicates similar values

#Indicates single collection

Table. 4.2.6: Percentage composition of zooplankton taxa of Dahej during October 2022.

Taxon	L1	L2	L3	L4	L5	L6	L7	L8	L9	L10	Av.
<b>Phylum: Protozoa</b>											
Foraminifera	-	-	-		<0.1	-	-	-	-	-	<0.1
<b>Phylum: Coelenterata</b>											
Hydrozoa	<0.1	-	-		<0.1	-		<0.1	0.2	-	<0.1
Scyphozoa	<0.1	-	-		<0.1	-		<0.1	<0.1	0.1	<0.1
<b>Phylum: Annelida</b>											
Polychaeta	<0.1	1.1	-		<0.1	-		-	<0.1	0.1	0.2
<b>Phylum: Arthropoda</b>											
<b>Class: Copepoda</b>											
<b>Order: Calanoida</b>											
Acartiidae	1.9	1.8	11.4		3.7	4.1		0.5	3.8	4.2	3.9
Calanidae	1.6	13.3	-		0.7	4.1		0.5	2.0	-	2.8
Candaciidae	1.2	-	-		0.1	-		0.2	1.6	-	0.4
Centropagidae	26.0	-	-		12.4	4.1		15.0	12.2	15.2	10.6
Eucalanidae	0.7	-	-		1.7	-		-	-	-	0.3
Euchaetidae	-	-	-		-	-		0.1	2.2	-	0.3
Lucicutiidae	0.4	-	-		<0.1	-		-	-	-	0.1
Paracalanidae	57.8	55.8	55.3		50.9	35.1		67.9	63.3	55.1	55.1
Pontellidae	1.3	-	-		2.5	-		0.7	<0.1	3.4	1.0
Pseudodiaptomidae	0.1	-	-		2.0	-		0.1	2.4	2.5	0.9
Temoridae	2.2	-	-		2.0	-	-	-	0.2	0.9	0.7
Tortanidae	1.2	-	-		0.1	-		-	-	0.9	0.3
<b>Order: Harpacticoida</b>											
Ectinosomatidae	0.9	13.5	25.5		1.6	45.9		-	0.2	-	10.9
Tachidiidae	-	0.6	-		-	-	-	-	-	-	0.1
Longipediidae	0.6	-	-		0.8	-		-	-	2.5	0.5
<b>Other Arthropods</b>											
Ostracoda	-	-	-		<0.1	-	-	-	<0.1	<0.1	<0.1
Cumacea	-	-	-		<0.1	-	-	-	-	-	<0.1
Amphipoda	<0.1	-	-		<0.1	-		-	<0.1	0.1	<0.1
Mysidacea	0.1	-	-		0.2	-		<0.1	<0.1	0.4	0.1
Isopoda	<0.1	0.9	1.4		<0.1	1.5		<0.1	<0.1	-	0.5
<b>Decapod larvae</b>											
Zoea	0.4	0.2	0.6		5.7	1.1		7.2	1.8	0.6	2.2
Megalopa	-	-	-		-	-		-	-	<0.1	<0.1
Mysis	0.3	-	-	-	1.6	-		1.9	0.1	0.1	0.5
<b>Phylum: Mollusca</b>											
Gastropoda	<0.1	3.4	1.6		0.1	-		<0.1	<0.1	0.1	0.6
Bivalvia	-	-	-		<0.1	-	-	-	<0.1	-	<0.1
<b>Phylum: Chaetognatha</b>											
Chaetognatha	3.01	9.1	2.7		13.3	2.9		5.6	9.6	13.2	7.4
<b>Phylum: Chordata</b>											

<b>Class: Tunicata</b>											
Copelata	-	0.3	-		<0.1	-		-	-	-	<0.1
<b>Class: Teleostei</b>											
Fish eggs	<0.1	-	0.4		<0.1	0.3		<0.1	-	0.1	0.1
Fish larvae	0.2	-	0.2		0.4	0.9		0.2	0.3	0.5	0.3
Others	<0.1	-	1.0		<0.1	-		-	-		0.2

Table 4.2.7a: Macrobenthos intertidal standing stock and faunal groups

<b>Transect</b>	<b>Biomass</b> (wet wt.; g/m <sup>2</sup> )	<b>Population</b> (no/m <sup>2</sup> )	<b>Faunal Group</b> (no)	<b>Major Group</b>
IT-I	0.03-8.7 (2.7)	25-1100 (446)	1-8 (5)	<i>Micronereides capensis</i> , <i>Nephtys paradoxa</i>
IT-II	0-0.2 (0.08)	0-150 (41)	0-3 (1)	<i>Sphaeroma walkeri</i> , <i>Glycera longipinnis</i>
IT-III	0.2-3.5 (1.6)	275-1125 (677)	1-10 (5)	<i>Micronereides capensis</i> , <i>Paraprionospio patiens</i>
IT-IV	0-3.4 (0.8)	0-850 (275)	0-6 (2)	<i>Micronereides capensis</i>
Overall Average	0-8.7 (1.3)	0-1125 (360)	0-10 (3)	<i>Micronereides capensis</i>

Table 4.2.7b: Composition (%) of intertidal macrobenthos at Dahej during October 2022.

Faunal Groups	IT-I			IT-II			IT-III			IT-IV			Av.
	HW	MW	LW	HW	MW	LW	HW	MW	LW	HW	MW	LW	
<b>Phylum Sipuncula</b>													<b>0</b>
Sipuncula			4.8									2.1	<b>0.4</b>
<b>Phylum Mollusca</b>													<b>0</b>
<i>Meretrix meretrix</i>	9	11.3						4	6.1				<b>4.1</b>
Bivalvia	24.6	11.3						1	17.4				<b>9.5</b>
Gastropoda											30		<b>0.9</b>
<b>Phylum Annelida</b>													<b>0</b>
<i>Aglaophamus dibranchis</i>	1.2		10.3										<b>0.6</b>
<i>Aramandia intermedia</i>	0.6					N			1.7				<b>0.4</b>
<i>Capitella capitata</i>			4.8	12		O	1			100		1	<b>2.8</b>
<i>Glycera longipinnis</i>	5.4	18.5	10.3		62				0.9		5		<b>3.1</b>
<i>Glycera</i> sp.												1	<b>0.1</b>
<i>Goniada emerita</i>												1	<b>0.1</b>
<i>Lumbrinereis meteorana</i>						C					10		<b>0.3</b>
<i>Lumbrinereis</i> sp.						O					10		<b>0.3</b>
<i>Mediomastus capensis</i>	5.4				19	L							<b>1.5</b>
<i>Pisionidens indica</i>			10.3			L							<b>0.3</b>
<i>Micronereides capensis</i>	21	18.5				E	95	76	0.9		40	90.7	<b>47.2</b>
<i>Nephtys hystricis</i>	1.8	3.6				C	1						<b>0.7</b>
<i>Nephtys paradoxa</i>	7.2		24.6			T			1.7				<b>2.8</b>
<i>Nephtys</i> sp.	2.4					I							<b>0.6</b>
<i>Notomastus</i> sp.	21	18.5	10.3			O							<b>6.2</b>
<i>Ophelina longicaudata</i>						N		3					<b>0.3</b>
<i>Paraprionospio</i>			10.3					15	23.5				<b>6</b>

<i>patiens</i>													
<i>Diopatra cuprea</i>	0.6	3.6											0.3
<i>Prionospio cirrifera</i>								9.6					1.6
<i>Prionospio sp.</i>			4.8					0.9					0.3
<b>Phylum Arthropoda</b>													0
<i>Ampelisca brevicornis</i>		3.6						0.9					0.3
<i>Baharilana sp.</i>		7.7	4.8								2.1		0.8
<i>Cumacea</i>							1	16.5					2.9
Decapod larvae		3.6		26	19		3	2.6			2.1		1.5
<i>Dexamine spinosa</i>								9.6					1.6
<i>Gammarus sp.</i>			4.8					1.7					0.4
<i>Mysidacea</i>										5			0.1
<i>Sphaeroma walkeri</i>				62				4.3					1.5
<i>Urothoe sp.</i>								1.7					0.3

Table 4.2.8a: Macrobenthos subtidal standing stock and faunal groups

Station	Biomass (wet wt.;g/m <sup>2</sup> )	Population (no/m <sup>2</sup> )	Faunal Group (no)	Major Group
L2	NIL			
L3	0-1.3 (0.3)	0-50 (17)	0-1 (1)	<i>Nephtys paradoxa</i>
L4	NIL			
L5	0-0.1 (0.04)	0-50 (16)	0-2 (1)	<i>Mediomastus capensis</i> , <i>Sigambra parva</i>
L6	0-0.23 (0.06)	0-25 (8)	0-1 (1)	<i>Nephtys paradoxa</i>
L7	NIL			
L8	0.1-1.1 (0.7)	25-75 (42)	1*	<i>Notomastus sp.</i>
L9	0-0.1 (0.05)	0-25 (8)	0-1 (1)	<i>Nephtys paradoxa</i>
L10	NIL			
OVERALL AVERAGE	0-1.3 (0.1)	0-75 (10.1)	0-2 (1)	<i>Notomastus sp.</i> , <i>Nephtys paradoxa</i>

Table 4.2.8b: Composition (%) of Subtidal macrobenthos at Dahej during October 2022.

Faunal Groups	Station					Av.
	L3	L5	L6	L8	L9	
<b>Phylum Annelida</b>						
<i>Sigambra parva</i>		50.0				<b>8.8</b>
<i>Mediomastus capensis</i>		50.0				<b>8.8</b>
<i>Nephtys paradoxa</i>	100.0		100.0		100.0	<b>36.2</b>
<i>Notomastus sp.</i>				100.0		<b>46.2</b>

\*Stations L4, L2, L7 and L10 are NIL.



Table 4.2.10a: Meiofaunal biomass, population and faunal groups at subtidal region

Station	Population (ind.10 cm <sup>-2</sup> )			Biomass (µg.10 cm <sup>-2</sup> )			Group (no.)		
	Min	Max	Av.	Min	Max	Av.	Min	Max	Av.
L1	1	8	3.77	1.4	1.6	1.47	1	2	1.33
L2	0	1	0.94	0.0	0.3	0.18	0	1	0.67
L3	0	8	3.30	0.0	108.4	36.22	0	4	1.67
L5	3	6	3.77	0.5	1.9	1.02	1	3	1.67
L7	14	34	25.01	0.5	1.6	1.09	2	4	3.00
L8	0	1	0.47	0.0	0.2	0.08	0	1	0.33
L9	0	3	1.42	0.0	0.2	0.08	0	1	0.67
L10	0	4	1.89	0.0	0.3	0.20	0	1	0.67

Table 4.2.10b: Percentage composition of benthic meiofauna in subtidal region during October 2022.

Group	Station							
	L1	L2	L3	L5	L7	L8	L9	L10
Amphipoda	0	0	0	0	0	0	0	0
Copepoda	25	0	14	13	4	0	0	0
Halacaroida	13	0	29	0	0	0	0	0
Insecta	0	0	0	0	0	0	0	0
Nauplius	0	0	0	0	8	0	0	0
Nematoda	63	100	43	75	85	100	100	100
Ostracoda	0	0	0	0	0	0	0	0
Polychaeta	0	0	14	0	0	0	0	0



<b>Oligochaeta</b>	0	0	0	13	0	0	0	0
<b>Minor phyla</b>	0	0	0	0	4	0	0	0
<b>Total</b>	100	100	100	100	100	100	100	100

Table 4.3.1: Description of the mangroves near to IT-II

<b>QUADRAT</b>		<b>1</b>	<b>2</b>	<b>3</b>
<b>LATITUDE</b>		21°41'13.00"N	21°41'13.4"N	21°41'13.50"N
<b>LONGITUDE</b>		72°31'37.00"E	72°31'43.97"E	72°31'48.50"E
<b>SPECIES</b>		<i>Avicennia marina</i>	<i>Avicennia marina</i>	<i>Avicennia marina</i>
<b>DENSITY</b>	<b>BIG PLANTS</b>	16 (5*5m)	5 (5*5m)	2 (5*5m)
	<b>INTERMEDIATE</b>	38 (5*5m)	14 (5*5m)	27 (5*5m)
	<b>SEEDLINGS</b>	12, 15, 17, 19 (1*1m)	18, 16, 22, 31 (1*1m)	19, 32, 26, 27 (1*1m)
<b>MEASUREMENTS</b>	<b>PLANT 1</b>	Height : 173cm DBH : 15cm	Height : 150cm DBH : 15cm	Height : 170cm DBH : 24cm
	<b>PLANT 2</b>	Height : 157cm DBH : 12cm	Height : 178cm DBH : 13cm	Height : 135cm DBH : 14cm
	<b>PLANT 3</b>	Height : 167cm DBH : 15cm	Height : 148cm DBH : 14cm	

Table 4.3.2: Description of the mangroves near to IT-IV

<b>QUADRAT</b>		<b>1</b>	<b>2</b>	<b>3</b>
<b>LATITUDE</b>		21°40'18.34"N	21°40'18.46"N	21°40'18.24"N
<b>LONGITUDE</b>		72°34'47.63"E	72°34'47.20"E	72°34'47.43"E
<b>SPECIES</b>		<i>Avicennia marina</i>	<i>Avicennia marina</i>	<i>Avicennia marina</i>
<b>DENSITY</b>	<b>BIG PLANTS</b>	6 (5*5m)	6 (5*5m)	6 (5*5m)
	<b>INTERMEDIATE</b>	9 (5*5m)	17 (5*5m)	18 (5*5m)
	<b>SEEDLINGS</b>	6, 4, 5, 7 (1*1m)	5, 6, 8, 2 (1*1m)	4, 7, 1, 2 (1*1m)
<b>MEASUREMENTS</b>	<b>PLANT 1</b>	Height : 158cm DBH : 19cm	Height : 164cm DBH : 17cm	Height : 189cm DBH : 14cm
	<b>PLANT 2</b>	Height : 170cm DBH : 15cm	Height : 172cm DBH : 19cm	Height : 153cm DBH : 17cm
	<b>PLANT 3</b>	Height : 172cm DBH : 27cm	Height : 152cm DBH : 19cm	Height : 173cm DBH : 24cm

Table 4.4.1: Taluka - wise fishermen population (as per 2007 survey)

Sr. No.	Taluka	Fishermen population				No. of fishing equipments	Total no. of fishing nets
		Male	Female	Children	Total		
1	Jambusar	1280	1192	2178	4650	943	15735
2	Amod	175	168	294	637	160	814
3	Vagra	1122	1090	1696	3908	870	26610
4	Bharuch	2311	2181	3778	8270	1715	96451
5	Jagadiya	1082	1038	1583	3703	533	17092
6	Ankleshwar	268	254	463	985	141	10787
7	Hansot	932	906	1343	3181	1103	21994
8	Valiya	334	315	621	1270	111	3223
<b>Total</b>		<b>7504</b>	<b>7144</b>	<b>11956</b>	<b>26604</b>	<b>5576</b>	<b>192706</b>

Table 4.4.2: Bharuch marine fishermen data of the Gujarat state

Sr. No.	Name of district	Name of taluka	Name of fishing villages	No. of families	Total population	Active fishermen
1	Bharuch	Hansot	Kantiyajal	80	349	226
<b>Total (a)</b>				<b>80</b>	<b>349</b>	<b>226</b>
2	Bharuch	Vagra	Lakhigam	40	235	186
3	Bharuch	Vagra	Luvara	75	455	196
4	Bharuch	Vagra	Dahej	120	526	322
5	Bharuch	Vagra	Muler	40	204	104
<b>Total (b)</b>				<b>275</b>	<b>1420</b>	<b>808</b>
6	Bharuch	Jambusar	Kavi	101	465	340
7	Bharuch	Jambusar	Sarod	71	420	183
8	Bharuch	Jambusar	Tankari	76	411	127
9	Bharuch	Jambusar	Nada	80	452	225
10	Bharuch	Jambusar	Malpur	138	657	548
11	Bharuch	Jambusar	Zamdi	80	419	198
12	Bharuch	Jambusar	Dehgam	50	253	124
13	Bharuch	Jambusar	Nahar	40	198	104
14	Bharuch	Jambusar	Kapuriya	26	148	82
15	Bharuch	Jambusar	Islampur	31	140	79
16	Bharuch	Jambusar	Asarsa	40	196	109
17	Bharuch	Jambusar	Devla	75	353	179
18	Bharuch	Jambusar	Kareli	40	205	95
19	Bharuch	Jambusar	Kamboi	70	333	174
<b>Total (c)</b>				<b>918</b>	<b>4650</b>	<b>2567</b>
<b>Grand Total (a+b+c)</b>				<b>1273</b>	<b>6419</b>	<b>3601</b>

Table 4.4.3: Fishermen vehicle and fish production details (2009-2021) and number of fishing boats in Bharuch district and Gujarat state, 2020-2021

Year	No. Of vehicles for fishing		Fish production (metric tonn)	
	Mechanical boats	Non-mechanical boats	Inland	Marine
2009	502	940	1578	6864
2010	681	940	14869	5804
2011	689	940	12915	6405
2012	624	940	11215	4500
2013	634	940	12450	3500
2014	634	940	12600	6500
2015	655	940	15450	7450
2016	645	940	10500	6621
2017	650	940	13000	5625
2018	674	940	7185	12050
2019	675	950	6554	12200
2020	675	950	5445	14025
2021	676	950	7580	17050
<b>Number of fishing boats in Bharuch district, Gujarat state, 2020-2021</b>				
<b>Mechanized boats</b>		<b>Number</b>		
Gillnetter		232		
Frp ibm		489		
<b>Total</b>		<b>721</b>		
<b>Non mechanized boats</b>		940		
<b>Total boats</b>		<b>1661</b>		

Table 4.4.4: Fish species from Landing Centres, Gujarat.

List of landing centres	Fish species	
	English name	Gujarati name
Kavi	Catla	Catla
Kamboi	Rohu	Rohu
Malpur	Mrigal	Mrigal
Zamdi	Prawn	Jhinga
Bhadbhut	Bombay duck	Bumla
Mehgam	Silver pomfret	Paplet
Lakhigam	Chinese pomfret	Prupchanda
Luvara	Mackerel	Surmai
Hansot	Mullet	Boi
	Pangasius	Pangasius
	Tilapia	Tilapia
	Mudskipper	Levta

Table 4.4.5: District and year wise inland fish production in Bharuch district, Gujarat State from 2005-06 to 2020-21

<b>Year</b>	<b>Inland fish production of Gujarat state</b>	<b>Inland fish production of Bharuch district</b>
<b>2005-06</b>	69936	8743
<b>2006-07</b>	76821	26452
<b>2007-08</b>	78780	21902
<b>2008-09</b>	82047	15778
<b>2009-10</b>	84071	14810
<b>2010-11</b>	85972	14869
<b>2011-12</b>	91231	12915
<b>2012-13</b>	94930	11390
<b>2013-14</b>	102913	10000
<b>2014-15</b>	111482	18812
<b>2015-16</b>	112232	11243
<b>2016-17</b>	116725	11728
<b>2017-18</b>	137685	11408
<b>2018-19</b>	142880	20687
<b>2019-20</b>	157463	19881
<b>2020-21</b>	124705	17106
<b>% (2020-21)</b>	100	13.72

Table 4.4.6: Center wise & species wise marine fish production for the year 2010-11

<b>District : Bharuch</b>									
<b>Sr. No.</b>	<b>Name of fish</b>	<b>Name of Center</b>							<b>Total</b>
		<b>Malpur</b>	<b>Kavi</b>	<b>Kantiajal</b>	<b>Luvara</b>	<b>Lakhigam</b>	<b>Zamdi</b>		
		<b>1</b>	<b>2</b>	<b>4</b>	<b>5</b>	<b>6</b>	<b>7</b>		
1	Bombay duck	145710	136045	169150	132995	131050	145975	<b>860925</b>	
2	Other clupeids	67525	80420	105800	70890	74470	77890	<b>476995</b>	
3	Mullet	114400	100230	138630	100420	109450	112700	<b>675830</b>	
4	Cat fish	102465	100800	133100	77900	95825	102850	<b>612940</b>	
5	Shrimp	127215	131295	186250	140425	143250	163650	<b>892085</b>	
6	Crab	11000	0	2240	6020	17550	11750	<b>48560</b>	
7	Levta	47015	25980	98990	47350	65450	54000	<b>338785</b>	
8	Miscellaneous	117950	122600	132830	108100	126100	124320	<b>731900</b>	
<b>Total</b>		<b>733280</b>	<b>697370</b>	<b>966990</b>	<b>684100</b>	<b>763145</b>	<b>793135</b>	<b>4638020</b>	

(production in kilograms)

Table 4.4.7: Center wise & species wise marine fish production for the year 2011-12  
(production in kilograms)

District : Bharuch									
Sr. No.	Name of fish	Name of Center							Total
		Malpur	Kavi	Kantiajal	Luvara	Lakhigam	Zamdi		
		1	2	4	5	6	7		
1	Bombay duck	161750	149800	175450	136400	143800	142450	<b>909650</b>	
2	Hilsa	5250	3750	5250	1500	2250	2250	<b>20250</b>	
3	Other clupeids	102100	99450	122600	88850	62000	93850	<b>568850</b>	
4	Mullet	133400	128450	167500	111950	123050	114600	<b>778950</b>	
5	Cat fish	123200	118850	147350	82050	105400	103650	<b>680500</b>	
6	Shrimp	142950	143450	170650	146200	150550	133100	<b>886900</b>	
7	Crab	3000	0	0	0	2250	0	<b>5250</b>	
8	Levta	87550	0	137400	0	4500	0	<b>229450</b>	
9	Miscellaneous	137150	118700	175300	110850	129250	144000	<b>815250</b>	
<b>Total</b>		<b>896350</b>	<b>762450</b>	<b>1101500</b>	<b>677800</b>	<b>723050</b>	<b>733900</b>	<b>4895050</b>	



Table 4.4.8: Center wise & species wise marine fish production for the year 2012-13  
(production in kilograms)

<b>District : Bharuch</b>								
<b>Sr. No.</b>	<b>Name of fish</b>	<b>Name of Center</b>						<b>Total</b>
		<b>Malpur</b>	<b>Kavi</b>	<b>Kantiajal</b>	<b>Luvara</b>	<b>Lakhigam</b>	<b>Zamdi</b>	
		<b>1</b>	<b>2</b>	<b>4</b>	<b>5</b>	<b>6</b>	<b>7</b>	
1	Bombay duck	84470	90495	28939	82954	104245	126152	<b>517255</b>
2	Hilsa	0	0	0	5940	6300	0	<b>12240</b>
3	Other clupeids	31278	28617	16966	32388	48819	31766	<b>189834</b>
4	Coilia	0	0	0	0	0	4570	<b>4570</b>
5	Mullet	91230	90200	54946	69886	73415	79006	<b>458683</b>
6	Cat fish	22856	32040	14210	18924	38895	30178	<b>157103</b>
7	Perch	0	0	14860	0	0	9554	<b>24414</b>
8	Small sciaenids	0	0	0	0	0	7900	<b>7900</b>
9	Shrimp	174604	216655	83848	159954	164224	242192	<b>1041477</b>
10	Prawns (m)	0	4712	0	6634	6820	10480	<b>28646</b>
11	Crab	32366	10815	24100	16934	16144	22418	<b>122777</b>
12	Levta	139030	58509	148958	66438	67667	84026	<b>564628</b>
13	Miscellaneous	79480	84593	42940	65426	73785	87552	<b>433776</b>
<b>Total</b>		<b>655314</b>	<b>616636</b>	<b>429767</b>	<b>525478</b>	<b>600314</b>	<b>735794</b>	<b>3563303</b>

Table 4.4.9: Center wise & species wise marine fish production for the year 2013-14  
(production in kilograms)

District : Bharuch									
Sr. No.	Name of fish	Name of Center							Total
		Malpur	Kavi	Kantiajal	Luvara	Lakhigam	Zamdi		
		1	2	4	5	6	7		
1	Bombay duck	66983	90042	21263	75435	56860	111983	<b>422566</b>	
2	Hilsa	0	8400	0	15077	0	0	<b>23477</b>	
3	Other clupeids	26537	28057	10772	26540	23690	38843	<b>154439</b>	
4	Coilia	1550	930	0	0	0	0	<b>2480</b>	
5	Mullet	55644	67596	41384	69380	49305	86045	<b>369354</b>	
6	Cat fish	8979	11472	10282	11815	16585	20110	<b>79243</b>	
7	Silver bar	0	0	1240	0	0	0	<b>1240</b>	
8	Perch	0	0	4400	0	0	0	<b>4400</b>	
9	Small sciaenids	1705	9075	0	14440	840	5735	<b>31795</b>	
10	Shrimp	123259	194056	57388	148730	109435	264263	<b>897131</b>	
11	Prawns (m)	45080	27864	0	2665	775	5238	<b>81622</b>	
12	Crab	19649	3302	13323	17490	16840	18733	<b>89337</b>	
13	Levta	103117	23372	119247	61310	69325	73982	<b>450353</b>	
14	Sole	0	0	682	0	0	0	<b>682</b>	
15	Miscellaneous	62976	74413	33782	66915	56725	82400	<b>377211</b>	
<b>Total</b>		<b>515479</b>	<b>538579</b>	<b>313763</b>	<b>509797</b>	<b>400380</b>	<b>707332</b>	<b>2985330</b>	

Table 4.4.10: Center wise & species wise marine fish production for the year 2014-15  
(production in kilograms)

<b>District : Bharuch</b>									
<b>Sr. No.</b>	<b>Name of fish</b>	<b>Name of Center</b>							<b>Total</b>
		<b>Malpur</b>	<b>Kavi</b>	<b>Kantiajal</b>	<b>Luvara</b>	<b>Lakhigam</b>	<b>Zamdi</b>		
		<b>1</b>	<b>2</b>	<b>4</b>	<b>5</b>	<b>6</b>	<b>7</b>		
1	Bombay duck	76600	87039	58676	51800	54967	57850	<b>386932</b>	
2	Hilsa	0	0	0	0	16872	0	<b>16872</b>	
3	Other clupeids	29500	134828	23498	29470	30142	25830	<b>273268</b>	
4	Coilia	850	1860	0	0	0	0	<b>2710</b>	
5	Mullet	41660	87015	45164	46940	53885	32690	<b>307354</b>	
6	Cat fish	3440	46776	24524	7530	8454	21690	<b>112414</b>	
7	Small sciaenids	25540	8626	11690	38680	13995	11200	<b>109731</b>	
8	Shrimp	70360	114418	58484	80260	75482	62100	<b>461104</b>	
9	Prawns (m)	1450	2318	1250	1200	3326	1200	<b>10744</b>	
10	Crab	22640	26406	25072	21480	29539	25170	<b>150307</b>	
11	Levta	42730	7868	55306	36130	55553	36010	<b>233597</b>	
12	Miscellaneous	65570	104580	52654	56410	51070	47260	<b>377544</b>	
<b>Total</b>		<b>380340</b>	<b>621734</b>	<b>356318</b>	<b>369900</b>	<b>393285</b>	<b>321000</b>	<b>2442577</b>	

Table 4.4.11: Center wise & species wise marine fish production for the year 2015-16  
(production in kilograms)

<b>District : Bharuch</b>								
<b>Sr. No.</b>	<b>Name of fish</b>	<b>Name of Center</b>						
		<b>Malpur</b>	<b>Kavi</b>	<b>Kantiajal</b>	<b>Luvara</b>	<b>Lakhigam</b>	<b>Zamdi</b>	<b>Total</b>
		<b>1</b>	<b>2</b>	<b>4</b>	<b>5</b>	<b>6</b>	<b>7</b>	
1	Bombay duck	83985	100883	57520	44235	59770	58275	<b>404668</b>
2	Hilsa	0	0	0	0	16995	0	<b>16995</b>
3	Other clupeids	28927	159345	23545	23852	30811	25771	<b>292251</b>
4	Coilia	775	3295	0	0	0	0	<b>4070</b>
5	Mullet	43147	87900	47940	43571	52570	32337	<b>307465</b>
6	Cat fish	4965	49088	23962	9030	11462	21386	<b>119893</b>
7	Small sciaenids	24572	19035	12605	38158	13650	10100	<b>118120</b>
8	Shrimp	79385	114534	55112	83877	78030	66367	<b>477305</b>
9	Prawns (m)	1225	2985	985	1000	3175	965	<b>10335</b>
10	Crab	19870	22533	21306	20000	26027	24100	<b>133836</b>
11	Levta	44104	11169	55482	33755	54129	37993	<b>236632</b>
12	Miscellaneous	72280	134122	50443	56200	54755	52035	<b>419835</b>
<b>Total</b>		<b>403235</b>	<b>704889</b>	<b>348900</b>	<b>353678</b>	<b>401374</b>	<b>329329</b>	<b>2541405</b>

Table 4.4.12: Center wise & species wise marine fish production for the year 2016-17  
(production in kilograms)

<b>District : Bharuch</b>								
<b>Sr. No.</b>	<b>Name of fish</b>	<b>Name of Center</b>						
		<b>Malpur</b>	<b>Kavi</b>	<b>Kantiajal</b>	<b>Luvara</b>	<b>Lakhigam</b>	<b>Zamdi</b>	<b>Total</b>
		<b>1</b>	<b>2</b>	<b>4</b>	<b>5</b>	<b>6</b>	<b>7</b>	
1	Bombay duck	86380	102555	58430	45710	60980	59875	<b>413930</b>
2	Hilsa	0	0	0	0	17020	0	<b>17020</b>
3	Other clupeids	29850	161700	23650	24785	30425	26490	<b>296900</b>
4	Coilia	800	3350	0	0	0	0	<b>4150</b>
5	Mullet	43445	84520	48775	44845	53165	32620	<b>307370</b>
6	Cat fish	4550	49205	24750	9200	11930	22105	<b>121740</b>
7	Small sciaenids	25430	18870	12175	38785	14055	9850	<b>119165</b>
8	Shrimp	77620	119705	56250	86020	78160	69365	<b>487120</b>
9	Prawns (m)	1100	3080	990	1050	3410	950	<b>10580</b>
10	Crab	20080	24180	21660	20330	26540	25465	<b>138255</b>
11	Levta	45450	11480	56340	33670	55805	38825	<b>241570</b>
12	Miscellaneous	71955	131220	49390	53470	56395	52080	<b>414510</b>
<b>Total</b>		<b>406660</b>	<b>709865</b>	<b>352410</b>	<b>357865</b>	<b>407885</b>	<b>337625</b>	<b>2572310</b>

Table 4.4.13: Center wise & species wise marine fish production for the year 2017-18  
(production in kilograms)

<b>District : Bharuch</b>								
<b>Sr. No.</b>	<b>Name of fish</b>	<b>Name of Center</b>						<b>Total</b>
		<b>Malpur</b>	<b>Kavi</b>	<b>Kantiajal</b>	<b>Luvara</b>	<b>Lakhigam</b>	<b>Zamdi</b>	
		<b>1</b>	<b>2</b>	<b>4</b>	<b>5</b>	<b>6</b>	<b>7</b>	
1	Bombay duck	135940	68275	63591	67815	55891	66183	<b>457695</b>
2	Hilsa	0	0	0	0	20815	0	<b>20815</b>
3	Other clupeids	65268	100691	49008	40478	36603	50849	<b>342897</b>
4	Coilia	1520	14867	0	0	0	0	<b>16387</b>
5	Mullet	69051	83917	96855	62288	62985	51216	<b>426312</b>
6	Cat fish	7670	87820	61743	9914	11375	52931	<b>231453</b>
7	Small sciaenids	58048	18870	5671	41092	42268	1050	<b>166999</b>
8	Shrimp	108988	120877	115771	103679	106749	93180	<b>649244</b>
9	Prawns (m)	2125	7482	1250	2560	7192	1957	<b>22566</b>
10	Crab	47116	62666	56786	35831	53990	58198	<b>314587</b>
11	Levta	55201	12560	45357	37953	44829	39794	<b>235694</b>
12	Sole	0	0	0	1800	0	0	<b>1800</b>
13	Miscellaneous	61482	154818	50622	49931	59634	47175	<b>423662</b>
<b>Total</b>		<b>612409</b>	<b>732843</b>	<b>546654</b>	<b>453341</b>	<b>502331</b>	<b>462533</b>	<b>3310111</b>

Table 4.4.14: Center wise & species wise marine fish production for the year 2018-19  
(production in kilograms)

<b>District : Bharuch</b>								
<b>Sr. No.</b>	<b>Name of fish</b>	<b>Name of Center</b>						
		<b>Malpur</b>	<b>Kavi</b>	<b>Kantiajal</b>	<b>Luvara</b>	<b>Lakhigam</b>	<b>Zamdi</b>	<b>Total</b>
		<b>1</b>	<b>2</b>	<b>4</b>	<b>5</b>	<b>6</b>	<b>7</b>	
1	Bombay duck	107943	55756	51339	71185	61621	69058	<b>416902</b>
2	Hilsa	1602	867	0	0	17280	0	<b>19749</b>
3	Other clupeids	64395	83518	48319	41802	52366	57454	<b>347854</b>
4	Coilia	1520	16779	0	0	0	0	<b>18299</b>
5	Mullet	60767	85937	88504	71429	64452	60864	<b>431953</b>
6	Cat fish	12882	87558	62073	8625	9428	57109	<b>237675</b>
7	Small sciaenids	69428	19362	6902	47344	52605	1255	<b>196896</b>
8	Shrimp	93225	116504	113158	98758	113637	96947	<b>632229</b>
9	Prawns (m)	2125	7657	1250	2560	6001	9557	<b>29150</b>
10	Crab	46573	58957	61008	36645	55334	58323	<b>316840</b>
11	Levta	50553	12752	41724	40992	40864	43038	<b>229923</b>
12	Tuna	0	0	0	0	2	0	<b>2</b>
13	Sole	0	0	0	2055	0	0	<b>2055</b>
14	Miscellaneous	84222	162291	58087	48283	43646	50859	<b>447388</b>
<b>Total</b>		<b>595235</b>	<b>707938</b>	<b>532364</b>	<b>469678</b>	<b>517236</b>	<b>504464</b>	<b>3326915</b>

Table 4.4.15: Center wise & species wise marine fish production for the year 2019-2020  
(production in kilograms)

District : Bharuch								
Sr. No.	Name of fish	Name of Center						
		Malpur	Kavi	Kantiajal	Luvara	Lakhigam	Zamdi	Total
		1	2	4	5	6	7	
1	Bombay duck	107355	57596	52397	71218	60028	69067	<b>417661</b>
2	Hilsa	820	729	0	0	15776	0	<b>17325</b>
3	Other clupeids	65547	167995	48272	40596	54195	54223	<b>430828</b>
4	Coilia	1420	15712	0	0	0	0	<b>17132</b>
5	Mullet	62924	93269	90708	74252	71062	61644	<b>453859</b>
6	Cat fish	13035	96152	62297	10157	9690	59855	<b>251186</b>
7	Small sciaenids	71714	20095	7559	49061	58639	1582	<b>208650</b>
8	Shrimp	91677	119703	119362	96090	110793	95049	<b>632674</b>
9	Prawns (m)	1210	7197	1258	2650	4774	9420	<b>26509</b>
10	Crab	48247	62452	64674	36270	53515	57806	<b>322964</b>
11	Levta	51656	12946	41238	43961	41279	43240	<b>234320</b>
12	Sole	0	0	0	2254	0	0	<b>2254</b>
13	Miscellaneous	85952	153214	61526	45969	45223	51454	<b>443338</b>
<b>Total</b>		<b>601557</b>	<b>807060</b>	<b>549291</b>	<b>472478</b>	<b>524974</b>	<b>503340</b>	<b>3458700</b>



Table 4.4.16: Center wise & species wise marine fish production for the year 2020-2021  
(production in kilograms)

District : Bharuch									
Sr. No.	Name of fish	Name of Center							Total
		Malpur	Kavi	Kantiajal	Luvara	Lakhigam	Zamdi		
		1	2	4	5	6	7		
1	White pomfret	0	12710	15345	21205	0	14260	<b>63520</b>	
2	Black pomfret	10385	15810	23560	11005	22475	13020	<b>96255</b>	
3	Bombay duck	48360	21700	44795	21545	26970	44020	<b>207390</b>	
4	Hilsa	0	11935	12865	14880	6820	12865	<b>59365</b>	
5	Other clupeids	11470	9455	0	0	0	16430	<b>37355</b>	
6	Coilia	0	0	0	0	0	2170	<b>2170</b>	
7	Mullet	15345	21080	13330	22475	17360	21700	<b>111290</b>	
8	Cat fish	0	20460	15500	0	0	17380	<b>53340</b>	
9	Eel	10695	0	0	0	0	0	<b>10695</b>	
10	Seer fish	9300	16275	17980	16585	23715	16895	<b>100750</b>	
11	Small sciaenids	11005	0	0	19065	17515	0	<b>47585</b>	
12	Shrimp	17825	18755	25885	24335	61225	25885	<b>173910</b>	
13	Crab	25730	21390	15190	16245	51305	25265	<b>155125</b>	
14	Levta	57040	0	44175	23570	25088	36580	<b>186453</b>	
15	Miscellaneous	35030	25420	27745	23715	27435	31930	<b>171275</b>	
<b>Total</b>		<b>252185</b>	<b>194990</b>	<b>256370</b>	<b>214625</b>	<b>279908</b>	<b>278400</b>	<b>1476478</b>	

Table 4.5: List of water birds in the Gulf

Sr. No.	English name	Scientific name	Status in habitat	
			Salt pans	Gulf
<b>Podicipedidae</b>				
1	Great Crested Grebe	<i>Podiceps cristatus</i>	LM	-
2	Black necked Grebe	<i>Podiceps nigricollis</i>	M	-
<b>Pelecanidae</b>				
3	White Pelican	<i>Pelecanus onocrotalus</i>	LM	LM
4	Dalmatian Pelican	<i>Pelecanus crispus</i>	M	M
<b>Phalacrocoracidae</b>				
5	Cormorant	<i>Phalacrocorax carbo</i>	LM	LM
6	Indian Shag	<i>Phalacrocorax fuscicollis</i>	LM	LM
7	Little Cormorant	<i>Phalacrocorax niger</i>	LM	R
8	Darter	<i>Anhinga rufa</i>	LM	R
<b>Ardeidae</b>				
9	Grey Heron	<i>Ardea cinerea</i>	LM	R
10	Purple Heron	<i>Ardea purpurea</i>	LM	-
11	Little Green Heron	<i>Ardeola striatus</i>	LM	R
12	Pond Heron	<i>Ardeola grayii</i>	LM	R
13	Cattle Egret	<i>Bubulcus ibis</i>	-	LM
14	Large Egret	<i>Ardea alba</i>	LM	R
15	Smaller Egret	<i>Egretta intermedia</i>	LM	-
16	Little Egret	<i>Egretta garzetta</i>	LM	-
17	Indian Reef Heron	<i>Egretta gularis</i>	LM	R
18	Night Heron	<i>Nycticorax nycticorax</i>	LM	R
<b>Ciconiidae</b>				
19	Painted Stork	<i>Mycteria leucocephala</i>	LM	R
20	Blacknecked Stork	<i>Ephippiorhynchus asiaticus</i>	LM	LM
<b>Threskiornithidae</b>				
21	White Ibis	<i>Threskiornis aethiopica</i>	LM	R
22	Black Ibis	<i>Pseudibis papillasa</i>	-	R
23	Spoonbill	<i>Platalea leucorodia</i>	LM	R
<b>Phoenicopteridae</b>				
24	Flamingo	<i>Phoenicopterus roseus</i>	LM	LM
25	Lesser Flamingo	<i>Phoenicopterus minor</i>	LM	R
<b>Anatidae</b>				
26	Ruddy Shel duck	<i>Tadorna ferruginea</i>	-	M
27	Pintail	<i>Anas acuta</i>	M	M
28	Common Teal	<i>Anas crecca</i>	M	-
29	Spotbill Duck	<i>Anas poecilorhyncha</i>	LM	LM
30	Shoveller	<i>Anas clypeata</i>	M	-
<b>Accipitridae</b>				

31	Brahminy Kite	<i>Haliastur indus</i>	LM	R
32	Marsh Harrier	<i>Circus aeruginosus</i>	M	M
33	Osprey	<i>Pandian haliaetus</i>	M	M
<b>Gruidae</b>				
34	Common Crane	<i>Grus grus</i>	M	M
35	Demoiselle Crane	<i>Anthropoides virgo</i>	M	M
<b>Rallidae</b>				
36	Coot	<i>Fulica atra</i>	LM	LM
<b>Jacanidae</b>				
37	Pheasant - tailed Jacana	<i>Hydrophasianus chirurgus</i>	LM	-
<b>Haematopodidae</b>				
38	Oystercatcher	<i>Haematopus stralegus</i>	M	M
<b>Charadriidae</b>				
39	Redwattled Lapwing	<i>Vanellus indicus</i>	R	R
40	Grey Plover	<i>Pluvialis sugotarola</i>	M	M
41	Eastern Golden Plover	<i>Pluvialis dominica</i>	-	M
42	Large Sand Plover	<i>Charadrius leschenaultii</i>	M	M
43	Ringed Plover	<i>Charadrius hiaticula</i>	R	-
44	Kentish plover	<i>Charadrius alexandrinus</i>	R	R
45	Lesser Sand Plover	<i>Charadrius mongolus</i>	M	M
46	Whimbrel	<i>Numenius phaeopus</i>	M	M
47	Curlew	<i>Numenius arquata</i>	M	M
48	Blacktailed Godwit	<i>Limosa limosa</i>	M	-
49	Bartailed Godwit	<i>Limosa lapponica</i>	M	M
50	Spotted Redshank	<i>Tringa erythropus</i>	M	M
51	Common Redshank	<i>Tringa totanus</i>	M	M
52	Marsh Sandpiper	<i>Tringa stagnatilis</i>	M	M
53	Greenshank	<i>Tringa nebularia</i>	M	M
54	Green Sandpiper	<i>Tringa ochropus</i>	M	M
55	Wood Sandpiper	<i>Tringa glareola</i>	M	-
56	Terek Sandpiper	<i>Tringa terek</i>	M	M
57	Common Sandpiper	<i>Tringa hypoleucos</i>	M	M
58	Turnstone	<i>Arenaria interpres</i>	M	M
59	Knot	<i>Calidris carutus</i>	-	M
60	Eastern Knot	<i>Calidris tenuirostris</i>	-	V
61	Sanderling	<i>Calidris alba</i>	-	M
62	Eastern Little Stint	<i>Calidris ruficollis</i>	-	V
63	Little Stint	<i>Calidris minuta</i>	M	M
64	Dunlin	<i>Calidris alpina</i>	M	M
65	Curlew-Sandpiper	<i>Calidris testacea</i>	M	M
66	Broadbilled Sandpiper	<i>Limicola falcinellus</i>	M	M
67	Ruff and Reeve	<i>Philomachus pugnax</i>	M	M

68	Rednecked Phalarope	<i>Phalaropus lobatus</i>	M	M
<b>Recurvirostidae</b>				
69	Blackwinged Stilt	<i>Himantopus himantopus</i>	R	-
70	Avocet	<i>Recurvirostra avosetta</i>	LM	-
<b>Dromadidae</b>				
71	Crab Plover	<i>Dromas ardeola</i>	M	M
<b>Burhinidae</b>				
72	Great Stone Plover	<i>Esacus magnirostris</i>	LM	R
<b>Laridae</b>				
73	Herring Gull	<i>Larus argentatus</i>	M	M
<b>Lesser Blackbacked</b>				
74	Gull	<i>Larus fuscus</i>	M	M
75	Blackheaded	<i>Larus ichthyaetus</i>	M	M
76	Brownheaded Gull	<i>Larus brunnicephalus</i>	M	M
77	Blackheaded Gull	<i>Larus ridibunds</i>	M	M
78	Slenderbilled Gull	<i>Larus genei</i>	M	M
79	Whiskered Tern	<i>Chiildonias hybrida</i>	M	M
80	Whitewinged Black	<i>Chiildonias leucopterus</i>	M	M
<b>Tern</b>				
81	Gullbilled Tern	<i>Gelochelidon nilotica</i>	M	M
82	Caspian Tern	<i>Hdroprogne caspia</i>	LM	LM
83	Common Tern	<i>Sterna hirunda</i>	M	M
84	Whitecheeked Tern	<i>Sterna repressa</i>	M	M
85	Brownwinged Tern	<i>Sterna anaethetus</i>	M	M
86	Little Tern	<i>Sterna albitrons</i>	M	M
87	Saunders Little Tern	<i>Sterna saundersi</i>	LM	R
88	Large Crested Tern	<i>Sterna bergii</i>	M	M
89	Indian Lesser Crested Tern	<i>Sterna bengalensis</i>	M	M
90	Sandwich Tern	<i>Sterna sandvicensis</i>	M	M
91	Indian skimmer	<i>Rynchops albicollis</i>	LM	LM
<b>Alcedinidae</b>				
92	Common Kingfisher	<i>Alcedo atthis</i>	LM	LM
93	Whitebreast	<i>Halcyon smyrnensisq</i>	LM	LM
94	Blackcapped kingfisher	<i>Halcyon pileata</i>	M	M

R : Resident has been recorded breeding during the study.

LM : Local migrant, has not been recorded breeding during the study, but is known to nest within the state.

M : Migrant, does not breed in this area, spends the winter here and also sometimes the summer.

V : Not normally found in the area, one to few records only

Source: Saurashtra University (1991).

Table 4.5.1: List of avifauna observed at Dahej coast during the study period in October 2022

Common name	Scientific Name	IUCN status
Large Egret	<i>Ardea alba</i>	LC
Gray Heron	<i>Ardea cinerea</i>	LC
Western Yellow Wagtail	<i>Motacilla flava</i>	LC
Black headed Ibis	<i>Threskiornis</i>	NT
Black Drongo	<i>Dicrurus macrocercus</i>	LC
Indian Cormorant	<i>Phalacrocorax fuscicollis</i>	LC
Common Sandpiper	<i>Actitis hypoleucos</i>	LC
Indian pond Heron	<i>Ardeola grayii</i>	LC
Curlew	<i>Numenius arquata</i>	LC

\*NT - Near Threatened; LC- Least Concern

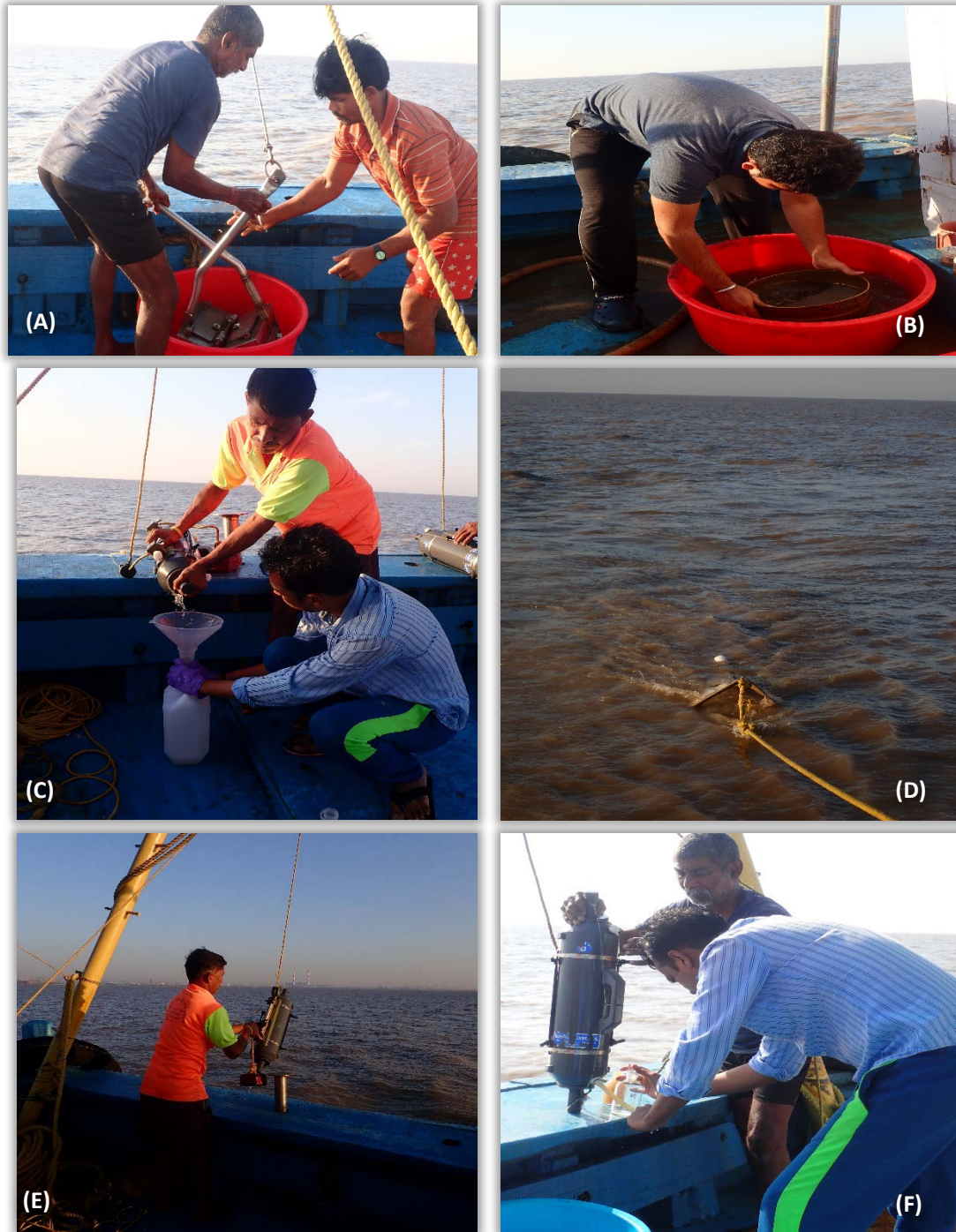

**Plate 1:** Photographs representing subtidal sampling at Dahej in October, 2022. A) Sediment collection using Van veen grab; B) Sieving of benthos sample; C) Collection of bottom water sample using Niskin sampler; D) Zooplankton sample collection using a Heron Tranter net; E) and F) Niskin sampler operation onboard for water sample collection.



**Plate 2:** View A) to F) of intertidal transect IT-III, project site for proposed LNG Jetty and intertidal Jetty corridor and G) & H) Intertidal sediment collections. Photographs were taken in October 2022

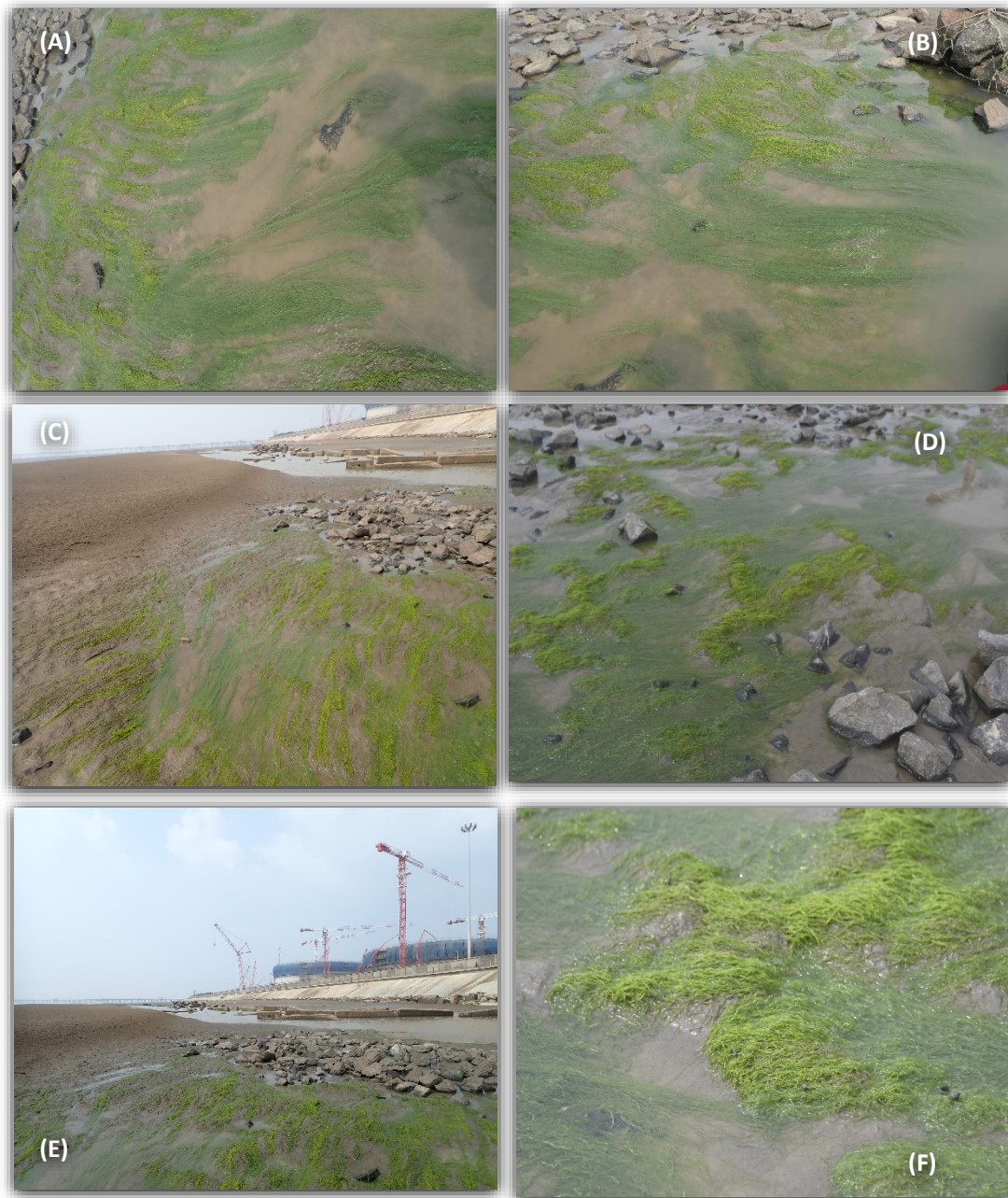

**Plate 3:** Photographs of patches of green algae (*Ulva intestinalis*) grown on sand covered rock of intertidal region of Dahej coast in in October, 2022 at intertidal transect ITS-III.

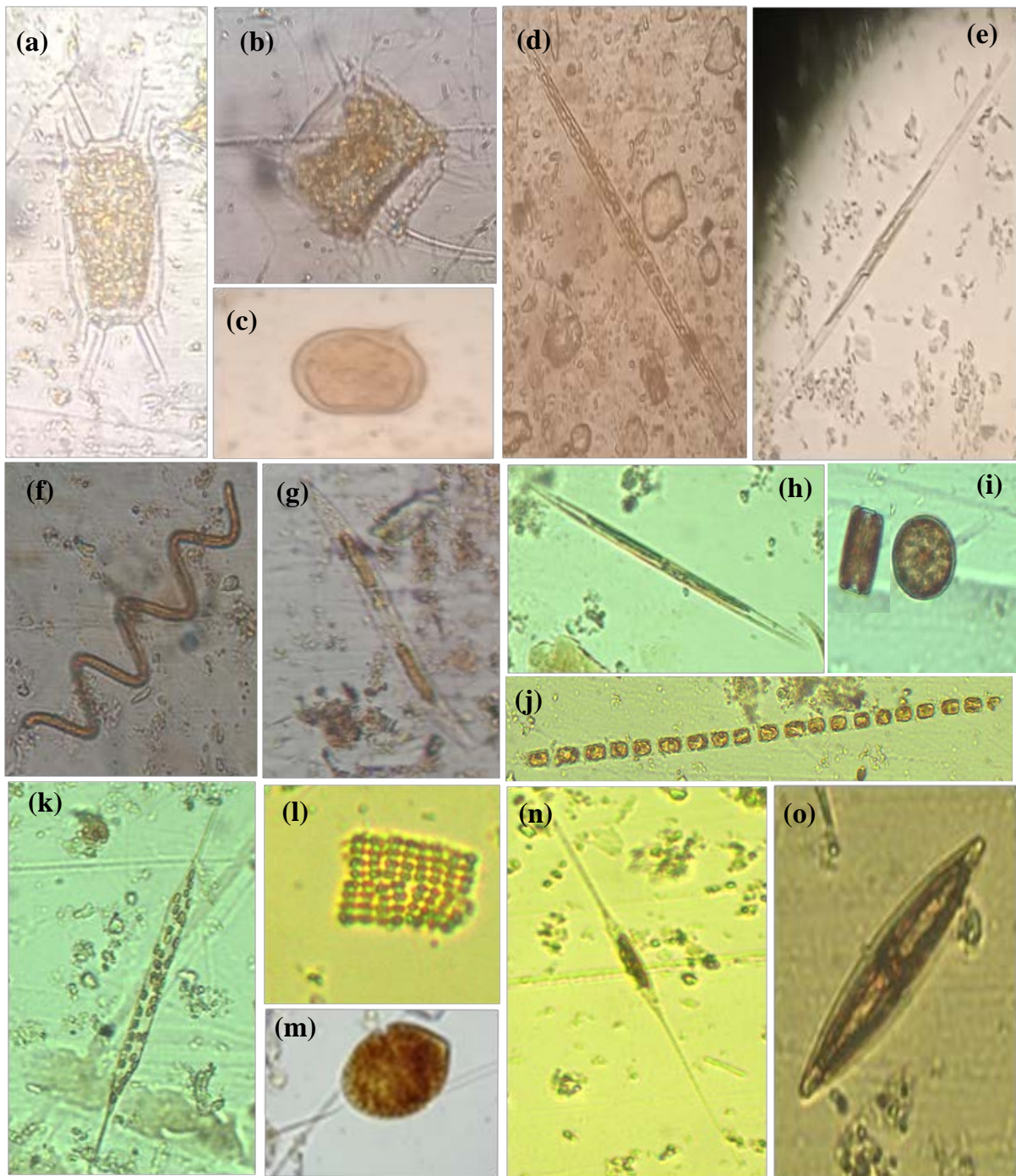



**Plate 4:** Mangrove Quadrant method survey from A) to F) at the North region (2.2 km) of proposed jetty in intertidal transect IT-II at Dahej during October 2022.



**Plate 5:** Mangrove Quadrant method survey from A) to F) at the South region (5.3 km) of proposed jetty in intertidal transect IT-IV at Dahej during October 2022



**Plate 6:** Major phytoplankton genera encountered in Dahej during October 2022

- (a) *Biddulphia sinensis* (b) *Biddulphia mobiliensis* (c) *Lepocinclis* sp. (d) *Synedra ulna* (e) *Nitzschia acicularis* (f) *Spirulina* sp. (g) *Pleurosigma* sp. (h) *Pseudo-nitzschia* sp. (i) *Thalassiosira* sp. (j) *Skeletonema costatum* (k) *Rhizosolenia setigera* (l) *Merismopedia* sp. (m) *Gymnodinium fuscum* (n) *Nitzschia longissima* (o) *Navicula transita*



**Plate 7:** Zooplankton groups identified from Dahej during October 2022

A) Foraminifera B) Hydrozoa C) Scyphozoa D) Chaetognatha E) Polychaeta F) Amphipoda G) Ostracoda H) Copepoda I) Isopoda  
 J) Decapoda K) Copelata L) Gastropoda M) Bivalvia N) Fish egg O) Fish larvae



**Plate 8:** Benthic macrofaunal groups identified in the study area in October 2022



*Harpodon nehereus*



*Sardinella fimbriata*



*Thyssa mystax*



*Scomberomorus sp.*



*Lisa sp.*



*Eleutheronima tetradactylum*



*Mystus sp.*



*Oreochromis mosambicus*



*Hilsa sp.*



*Parapenaopsis sculptilis*

**Plate 9:** Fishes present around Dahej area in October 2022

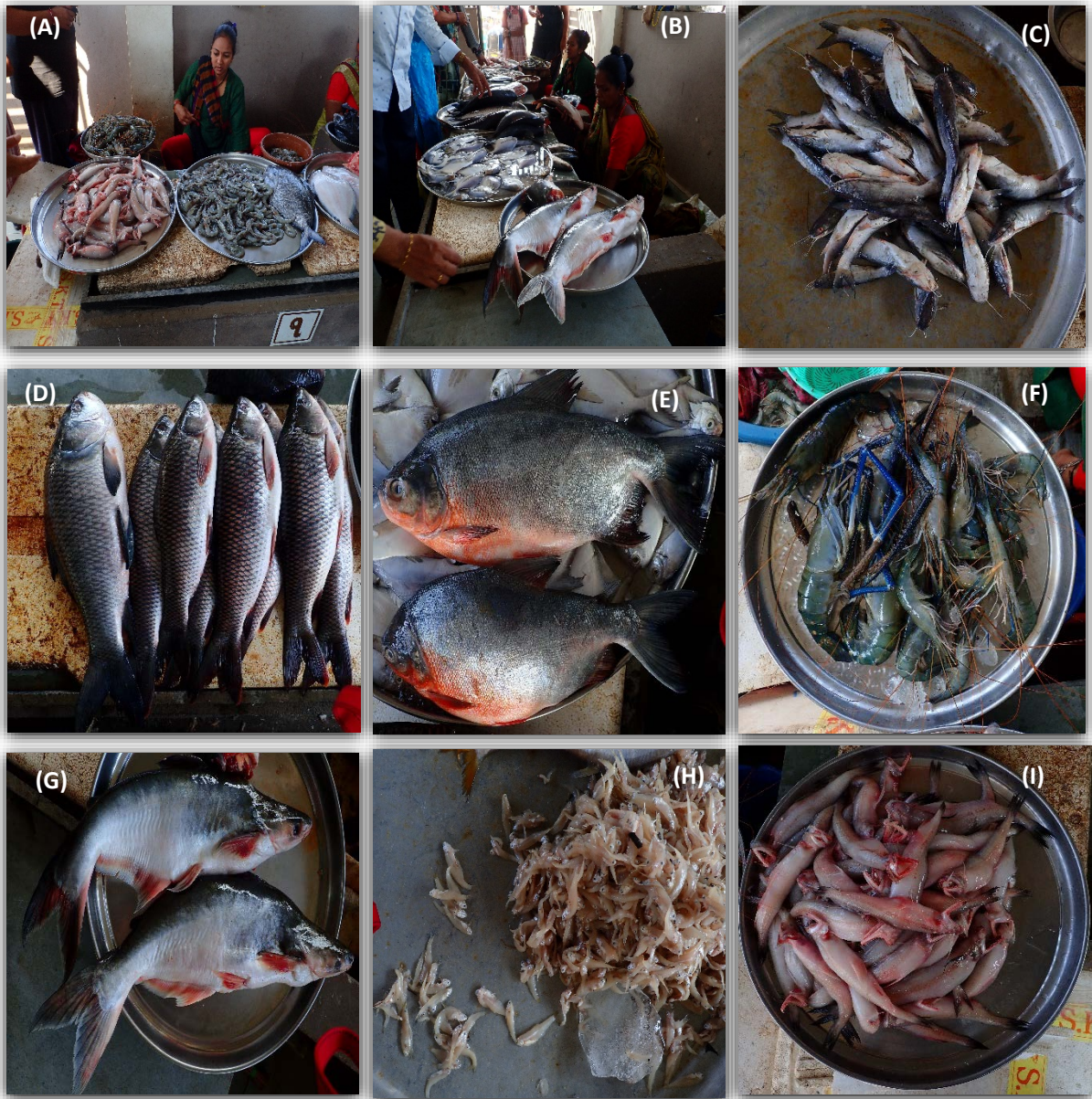

**Plate 10:** Fisheries survey in market at Baruch, Gujarat during October 2022



**Plate 11:** Photographs representing intertidal Biodiversity of A) to C) crabs; D) dead Lady crab; E) & H) Mudskippers observed at Dahej, October 2022



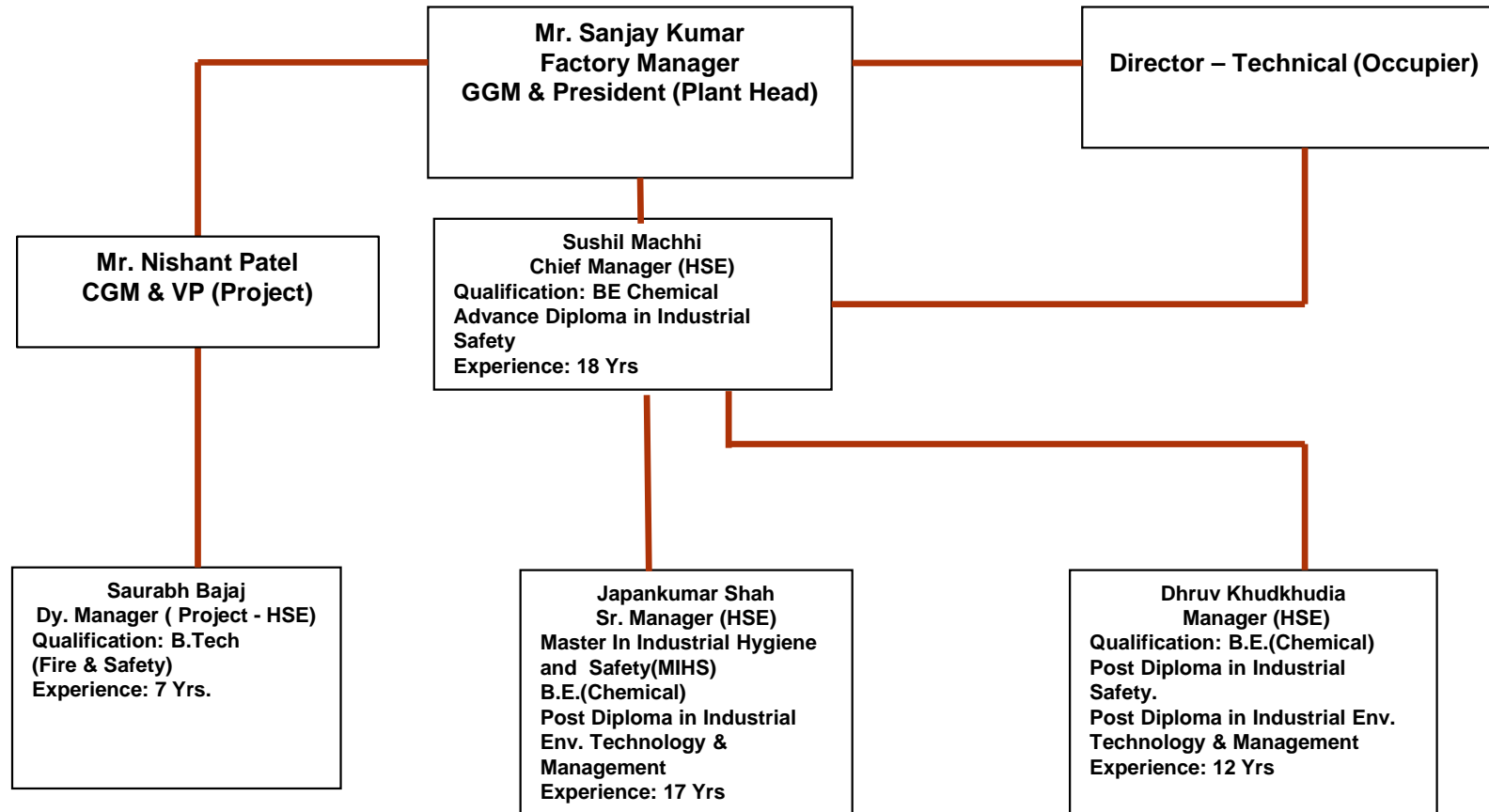

**Plate 12:** Avifauna and their intertidal feeding ground and habitat at Dahej in October, 2022. A) *Ardea alba*; B) *Ardea cinerea*; C) *Motacilla flava*; D) *Threskiornis melanocephalus*; E) *Dicrurus macrocercus*; F) *Phalacrocorax fuscicollis*; G) *Actitis hypoleucos*; and H) *Ardeola grayii*



# Annexure-XII

## EMC Organogram – PLL, Dahej



# GUJARAT



GUJARAT CONFIDENTIAL

## MATTER OF TIME

MADHYA PRADESH Deputy Chief Minister Rajendra Shukla on Friday said that it is a "matter of time" before former MP chief minister Kamal Nath also decides to switch over to the BJP. Shukla was responding to a query posed to him at the BJP Yuva Sammelan in Chhota Udepur district. (Kamal Nath joining the BJP) is a matter of time. Let's see. As everyone else is switching over, it is very likely that he will also eventually decide to join. The agenda has been a 'Congress Mukti Bharat' and we are almost there, as there is no one staying back in the Congress these days," Shukla said. He added that BJP workers had "begun their hard work on the ground" to ensure the "crucial" win for Prime Minister Narendra Modi in the 2024 Lok Sabha polls.

## TO THE BJP

FORMER DEDIAPADA MLA and Bharatiya Tribal Party (BTP) chief, Mahesh Vasava, on Friday met BJP state president C.P. Paati in Surat along with his supporters, hinting that he will shortly join the party formally. Vasava, who had withdrawn his nomination from his father Chhotubhai Vasava's Jagadga constituency in the 2022 Gujarat polls, has been missing from the public eye since the fall of his father and stepbrother Dilip, who went on to form the Bharatiya Adivasi Party. Mahesh's supporters in BTP are expected to join the BJP next week. He was earlier expected to join the BJP in January but his formal induction had been delayed due to "ongoing talks", sources said.

## STATE CABINET TO VISIT AYODHYA TEMPLE TODAY

**Gandhinagar:** The state Cabinet ministers are scheduled to visit Ram Mandir in Ayodhya seeking blessings of Lord Ram Saturday. The cabinet of ministers, led by Chief Minister Bhupendra Patel, will reach Ayodhya in the morning and offer prayers to Lord Ram between 11.30 am and 12 noon. Subsequently, they will also visit the temple near Saryu river and then return to Ahmedabad late in the evening. The cabinet of ministers will also be accompanied by Assembly Speaker Shankar Chaudhary, Chief Whip of BJP in Assembly Balakrishna Shukla and four deputy Whips Vijay Patel, Kausik Mehtaria, Raman Solanki and Jagdish Malwani. **ENS**

## CM SANCTIONS Rs 1,563 CRORE FOR RURAL ROADS

**Gandhinagar:** Chief Minister Bhupendra Patel Friday sanctioned to allocate of Rs 1,563 crore for the repair and strengthening of Panchayat roads in rural areas of the state. The fund has been sanctioned for better connectivity in internal rural areas. **ENS**

## NES & SEEM AREAS IN 3 YRS

# No students, 170 govt primary schools, 329 classes shut

RITUSHARMA AHMEDABAD, MARCH 1

IN THE last three years, around 170 government primary schools were closed down in nes and seem areas and 329 classes discontinued for want of students in Gujarat. Majority of these schools were in the districts of Devbhoomi Dwarka, Gir Somnath and Kutch.

Nes areas are clusters, majority of the maldhari (cattle-rearer) community living in forest areas, predominantly in Saurashtra. Meanwhile, families living along their farmlands, not necessarily in clusters, are found in seem areas.

According to the data tabled by the government in the Gujarat Assembly on February 26, the number of schools closed down in 2021-22 rose manifold when compared to 2020-21. While 20 schools were shut down in 2020-21, the figure increased to 133 the following year. However, in 2021-22, the number dropped to 17.

MLA Imran Khedwala, who had asked a starred question in this regard in the House, told *The Indian Express*: "They (state) have been closing down government schools and not opening new ones. While on one side, the government claims to achieve 100 per cent enrolment (in its schools), it is closing down schools, especially in areas where there is hardly any other option for children."

According to the data, 329 classes across schools, between classes I and VIII, had been closed

The number of schools closed down in 2021-22 rose manifold when compared to 2020-21, govt data reveals

The number of schools closed down in 2021-22, followed by 53 in 2021-22 and 10 in 2022-23.

While 42 schools and 107 classes were shut down in Devbhoomi Dwarka, Gir Somnath saw eight schools and 76 classes being shut. In Kutch, 9 schools and 47 classes closed down.

The government cited less number of students in schools and particular classes for this. "The schools must have been merged with nearby schools, due to less number of students," said Bhupendra Vasheja, Kutch District Primary Education Officer.

Devbhoomi Dwarka and Kutch also find place in the list of districts that have more than 10 per cent government primary schools being run by a single teacher. According to government data, while Devbhoomi Dwarka has 17.72 per cent such schools, the figure for Kutch was 10.54 per cent.

Of the 30,510 government primary schools across districts, 1,595 schools (5.22 per cent) are being run with a single teacher. The number of government primary schools with only one teacher in Gujarat has increased from around 700 to 1,606 in the last two years.



## COAST GUARD JETTY

Minister of State for Defence Ajay Bhatt inaugurates a jetty of the Coast Guard at Vadinar on the coast of Devbhumi Dwarka district on Friday. The jetty has been constructed at a cost of Rs 74 crore. Photo courtesy: Coast Guard

## FIRST CERTIFIED GREEN MUNICIPAL BOND FOR SUSTAINABLE WATER INFRASTRUCTURE

# VMC raises Rs 100 cr from green municipal bond

EXPRESS NEWS SERVICE VADODARA, MARCH 1

THE VADODARA Municipal Corporation (VMC) Friday successfully raised its 100 crore from the Certified Green Municipal Bond for Sustainable Water Infrastructure, which opened for bidding on the electronic bidding platform of the BSE. The VMC received 44 bids on BSEBOND platform for its Rs 1,460 crore bid in a second of opening the bid.

In a statement, the VMC said, "VMC received 44 bids on BSEBOND platform for its Rs 1,460 crore, 14.6 times of the issue size. Issue was oversubscribed by 8 times within a second of its opening... VMC has received the subscription amount of its 100 crore at an yield of 7.9 per cent — standing at

the most competitive rates amongst municipal bond issuances in India."

It added that the fund received from the bonds would be used in three projects — a 100-MLD sewage treatment plant (STP) at Sherki, a 21-MLD STP and pumping station at Udera and new auxiliary pumping stations, pressures lines and drainage network at Bil Village, which will help in disposal of sewage water effectively.

"These projects would ultimately contribute towards improvement in air and water quality as the sewage water would be collected, treated and discharged...," the statement said, adding that the water would be reused for industry purposes and thus help save fresh water.

VMC's municipal bond has been dual rated AA/Stable and AA/Stable by India Rating & Research Private Limited and CRISIL Rating Limited, respectively. The VMC has decided to mobilise Rs 100 crore against its contribution of Rs 620.6 crore for 47 projects worth Rs 1220.53 crore, approved under the AMRUT 2.0 scheme. The bond will be listed on BSE on March 6.

**Petron LNG Limited**  
GIDC Industrial Estate, Plot No. 71A, Dahaj Taluka, Vagra, Dist, Bharuch (Gujarat)-392130

**NOTICE OF ENVIRONMENTAL CLEARANCE BY MINISTRY OF ENVIRONMENT, FOREST AND CLIMATE CHANGE FOR "EXPANSION OF REGASIFICATION CAPACITY OF DAHEJ TERMINAL FROM 20 MMTPA TO 25 MMTPA" AT PETRON LNG TERMINAL, DAHEJ, TALUKA - VAGRA, DISTRICT - BHARUCH, GUJARAT**

Notice is hereby given to all concerned and P.W.C at large, that "Expansion of Regasification Capacity of Dahej Terminal from 20 MMTPA to 25 MMTPA" at Petron LNG Terminal, Dahaj, Bharuch, Gujarat by M/s Petron LNG Limited (PLL) has been accorded Environmental clearance from MOEF/CC vide EC Identification No. EC23/3501/G/566975/N dated 19<sup>th</sup> February 2024. The copy of said clearance letter is available at PLL website and may also be seen at [www.petronlinc.in](http://www.petronlinc.in).

**NATIONAL CENTRE FOR SUSTAINABLE COASTAL MANAGEMENT (NCSM)**  
(Ministry of Environment, Forest and Climate Change, Govt. of India)  
Anna University Campus, Chennai 600025.  
Ph: (+91) 44 22200060, Fax: (+91) 44 22200070, email: [careers@nscsm.res.in](mailto:careers@nscsm.res.in)  
Advt. No: NR 01/2024  
Advertisement for the selection of Project Staff  
NCSM requires Project Staff in one of the projects on contractual basis. Interested and eligible candidates may apply online on or before 16/03/2024.  
Further details relating to application procedure, eligibility criteria, interview dates, etc., may be obtained from the website <http://nscsm.res.in/career/>  
Director, NCSM

**INDIAN INSTITUTE OF SCIENCE**  
Bangalore - 560012.  
Corrigendum to Advertisement for the post of Assistant Registrar dated 10.02.2024  
It is hereby notified that the last date for submission of application for the post of Assistant Registrar is hereby extended till 08.03.2024 (11:55 p.m.).  
The eligibility criteria and other terms and conditions remains the same.  
Date: 01.03.2024 Sd/-, REGISTRAR

**Final Notice for Assessment of Contribution u/s 45 A of ESI Act**  
Whereas various notices like C18 adhoc/SCN were issued to the following defaulter employers but the same could not be served through post or otherwise at the address(es) available/intimated by the employer against each. Therefore below mentioned employers are hereby advised to appear before the Authorised Officer at ESIC Ahmedabad within 15 days of the date of publication of this advertisement with relevant records like TR, balance sheet, P.F.I. account, ledgers, bank books, salary/wage register, bills, vouchers etc. Failure to appear with all relevant records may lead to ex-parte assessment without any further notice in this regard.

Sr. No.	Code no	Name of factest	Address of factest	Type of Notice	Date of Hourin	Amount	Name of Principal Employer	Address of Principal Employer	Remarks
1.	37901126260 001019	M/s Vijaykumar Rameshwar Andradi	Near Ranaji Mandri Village, Bishelwarpura, PO Chhabra, Tal Kadi, 382740	C-18 Adhoc dated: 28/8/2023	3/10/20 23	Rs. 2,22,222.27	Vijaykumar Rameshwar Andradi	-	-
2.	37901127220 000999	M/s Shiv Traders Labour Supplier	Shree Ecolux, H/102, Nr Devanandan Oppara Camp, Vastral 382438	C-18 Adhoc dated: 10/20/23	3/1/20 23 21/1/22 023	Rs. 6,02,910.97	Shri Devendrasingh	C-67 Rameshwar Residency, Kanwada Ahmedabad Gujarat	-
3.	37901128850 001099	M/s Klog Security and Facility Management Service (OPC) Pvt Ltd	Shop S/2 Satyam Arcade, Surkheji Bavia Road, Moriya, 382213	C-18 Adhoc dated: 27/01/2023	13/02/2 023	Rs. 77,616.16	Shri Sourabh Sharma	358 Shambha Nagar, Shikolabad, Firozabad	-
4.	37901142610 001018	M/s Kingal Security Agency	NH 27 Opp New Airport Navadivhu Apartment Chhaya 380575	C-18 Adhoc dated: 17/08/2023	14/09/2 023	Rs. 3,16,701.16	Shri Ram Anjanibhai Shrivastava	NH 27 Opp New Airport Navadivhu Apartment Chhaya 380575	-
5.	37901136900 000999	M/s Vash Security Services	311 3rd Floor Super Mill 2 Indulife Gandhinagar 382007	C-18 Adhoc dated: 3/10/2023	1/11/20 23 & 17/07/2 023	Rs. 6,14,068.87	Shri Manmohansing Ji Chaudhan	Behind Inquiry Office, 169/2 Sector 7 Gandhinagar Gujarat 382007	Show Cause Notice dated 3/10/2023 also issued for non production of records to the SSO
6.	37901134700 001009	M/s Lakhansingh P Rathod	A 30, People Plaza(Celler) Navrangpura, Ahmedabad 380009	C-18 Adhoc	12/04/2 023 & 17/07/2 023	Rs. 2,49,480.00	Shri Lakhansingh P Rathod	A30, People Plaza (Celler) Navrangpura, Ahmedabad 380009	-
7.	37901131150 000999	M/s Somnagar Electrical	FF-108, Ship Arcade, L.B.S. Road, Hirwadi, Begunagar, Ahmedabad	C-18 Adhoc	25/10/2 023	Rs. 1,40,448.87	Shri Yajuvendrasinh Bhavansinh Rajani	B-14, Rajanani Society, India Colony, Begunagar, Ahmedabad	-
8.	37901134690 001099	M/s Riva Enterprise	Address 1: A Colony, Rabban Park, Morakanda Road, Jamnagar-361110 Address 2: Near EK, de EK Bapu Dargah, Opp Vasilu Jamnagar, Gujarat - 361002	C-18 Adhoc	15/9/20 23 & 16/10/2 023	Rs. 3,08,362.97	Kulkarni Intiyasa J Chhabhai Chhabhan	T, A Colony, Rabban Park, Morakanda Road, Jamnagar-361110	SSO visited to deliver the notice however employer refused to accept it and denied giving acknowledgement

Regional Director (I/c)

**GROUND IN A STONE CHAKKI**  
WHICH GIVES BETTER QUALITY ATTA & DELICIOUS SOFT ROTIS

**100% ATTA 0% MAIDA**  
**6 HOURS SOFTNESS**

**Parle-G SELECT CHAKKI ATTA WHEAT FLOUR**





India's favourite biscuit, now Bigger, Richer and Tastier  
Goodness of Parle-G Combined with the Nutrition of Healthy Grains & Berries

Everything is Royal with Parle-G Royale  
Royal Size, Royal Bite, Royal Taste

Also try our other variants

**Communication for grant of Environmental Clearance for Expansion of regasification capacity of Dahej terminal from 20 MMTPA to 25 MMTPA.**

મેસર્સ પેટ્રોનેટ LNG લિમિટેડ (PLL) દ્વારા પેટ્રોનેટ એલએનજી ટર્મિનલ, દહેજ, ભરૂચ, ગુજરાત ખાતે " રિગેસિફિકેશન ક્ષમતા 20 MMTPA થી 25 MMTPA " સુધી ના વિસ્તરણ માટેની પર્યાવરણીય મંજૂરી આપવામાં આવી છે. પર્યાવરણ, વન અને આબોહવા પરિવર્તન મંત્રાલય દ્વારા EC No. EC23A3501GJ5666975N તારીખ 19મી ફેબ્રુઆરી 2024 ના રોજ મંજૂરી આપવામાં આવેલ છે. પર્યાવરણીય મંજૂરીની નકલ તમને સંદર્ભ અને પ્રદર્શન માટે સોંપવામાં આવી છે.

ક્રમાંક	ગામનું નામ	તાલુકાનું નામ	તલાટીશ્રી / સરપંચશ્રી નું નામ	હસ્તાક્ષર તલાટીશ્રી / સરપંચશ્રી
૧	લખીગામ	વાગરા	Sarpanch: Amarsinh Rathod Talati - Omkarsinh Rana	પરમાર ત્રિવેરા .પી. ગામ પંચાયત - લખીગામ વાગરા 
૨	લુવારા	વાગરા	Sarpanch - Ishwarbhai Talati - Anupbhai Modi	 સરપંચ ગામ પંચાયત - લુવારા તા. વાગરા, જી. ભરૂચ
૩	અંબેશા	વાગરા	Sarpanch:- Shilpaben Rathod Talati:- Vikramsinh Chavda	
૪	જાગેશ્વર	વાગરા	Sarpanch - Naginbhai Kashi Bhai Talati - Vikramsinh Chavda	 સરપંચ ગામ પંચાયત - જાગેશ્વર તા. વાગરા, જી. ભરૂચ
૫	દહેજ	વાગરા	Sarpanch Jaydipsinh Rane  Talati Vijaybhai Rathod	 તલાટી કમ મંત્રી ગામ પંચાયત - દહેજ તા. વાગરા, જી. ભરૂચ